

KE-430FX KE-430FS BE-438FX

INSTRUCTION MANUAL

Please read this manual before using the machine.
Please keep this manual within easy reach for quick reference.

ELECTRONIC DIRECT DRIVE LOCKSTITCH BAR TACKER
ELECTRONIC DIRECT DRIVE LOCKSTITCH BUTTON SEWER



Thank you very much for buying a BROTHER sewing machine. Before using your new machine, please read the safety instructions and the explanations given in the instruction manual.

With industrial sewing machines, it is normal to carry out work while positioned directly in front of moving parts such as the needle and thread take-up, and consequently there is always a danger of injury that can be caused by these parts. Follow the instructions from training personnel and instructors regarding safe and correct operation before operating the machine so that you will know how to use it correctly.



SAFETY INSTRUCTIONS

1. Safety indications and their meanings

This instruction manual and the indications and symbols that are used on the machine itself are provided in order to ensure safe operation of this machine and to prevent accidents and injury to yourself or other people.

The meanings of these indications and symbols are given below.

Indications

 DANGER	The instructions which follow this term indicate situations where failure to follow the instructions will result in death or serious injury.
 CAUTION	The instructions which follow this term indicate situations where failure to follow the instructions could cause injury when using the machine or physical damage to equipment and surroundings.

Symbols



..... This symbol () indicates something that you should be careful of. The picture inside the triangle indicates the nature of the caution that must be taken.
(For example, the symbol at left means “beware of injury”.)



..... This symbol () indicates something that you must not do.



..... This symbol () indicates something that you must do. The picture inside the circle indicates the nature of the thing that must be done.
(For example, the symbol at left means “you must make the ground connection”.)

2. Notes on safety

DANGER



Wait at least 5 minutes after turning off the power switch and disconnecting the power cord from the wall outlet before opening the face plate of the control box. Touching areas where high voltages are present can result in severe injury.

CAUTION

Environmental requirements



Use the sewing machine in an area which is free from sources of strong electrical noise such as electrical line noise or static electric noise. Sources of strong electrical noise may cause problems with correct operation.



Any fluctuations in the power supply voltage should be within $\pm 10\%$ of the rated voltage for the machine. Voltage fluctuations which are greater than this may cause problems with correct operation.



The power supply capacity should be greater than the requirements for the sewing machine's power consumption. Insufficient power supply capacity may cause problems with correct operation.



The ambient temperature should be within the range of 5°C to 35°C during use. Temperatures which are lower or higher than this may cause problems with correct operation.



The relative humidity should be within the range of 45% to 85% during use, and no dew formation should occur in any devices. Excessively dry or humid environments and dew formation may cause problems with correct operation.



In the event of an electrical storm, turn off the power and disconnect the power cord from the wall outlet. Lightning may cause problems with correct operation.

Installation



Machine installation should only be carried out by a qualified technician.



Contact your Brother dealer or a qualified electrician for any electrical work that may need to be done.



The sewing machine weighs approximately 57 kg. The installation should be carried out by two or more people.



Do not connect the power cord until installation is complete, otherwise the machine may operate if the foot switch is depressed by mistake, which could result in injury.



Hold the machine head with both hands when tilting it back or returning it to its original position. Furthermore, after tilting back the machine head, do not push the face plate side or the pulley side from above, as this could cause the machine head to topple over, which may result in personal injury or damage to the machine.



Be sure to connect the ground. If the ground connection is not secure, you run a high risk of receiving a serious electric shock, and problems with correct operation may also occur.



All cords should be secured at least 25 mm away from any moving parts. Furthermore, do not excessively bend the cords or secure them too firmly with staples, otherwise there is the danger that fire or electric shocks could occur.



Install the safety covers to the machine head and motor.



If using a work table which has casters, the casters should be secured in such a way so that they cannot move.













Be sure to wear protective goggles and gloves when handling the lubricating oil and grease, so that they do not get into your eyes or onto your skin, otherwise inflammation can result.

Furthermore, do not drink the oil or eat the grease under any circumstances, as they can cause vomiting and diarrhoea.



Keep the oil out of the reach of children.

CAUTION









Sewing

-  This sewing machine should only be used by operators who have received the necessary training in safe use beforehand.
-  The sewing machine should not be used for any applications other than sewing.
-  Be sure to wear protective goggles when using the machine.
If goggles are not worn, there is the danger that if a needle breaks, parts of the broken needle may enter your eyes and injury may result.
-  Turn off the power switch at the following times, otherwise the machine may operate if the foot switch is depressed by mistake, which could result in injury.
 - When replacing the needle and bobbin
 - When not using the machine and when leaving the machine unattended
-  Use threading mode or turn off the power first in order to carry out threading.
-  If using a work table which has casters, the casters should be secured in such a way so that they cannot move.
-  Attach all safety devices before using the sewing machine. If the machine is used without these devices attached, injury may result.
-  Do not touch any of the moving parts or press any objects against the machine while sewing, as this may result in personal injury or damage to the machine.
-  If an error occurs in machine operation, or if abnormal noises or smells are noticed, immediately turn off the power switch. Then contact your nearest Brother dealer or a qualified technician.
-  If the machine develops a problem, contact your nearest Brother dealer or a qualified technician.

Cleaning

-  Turn off the power switch before carrying out cleaning, otherwise the machine may operate if the foot switch is depressed by mistake, which could result in injury.
-  Be sure to wear protective goggles and gloves when handling the lubricating oil and grease, so that they do not get into your eyes or onto your skin, otherwise inflammation can result.
Furthermore, do not drink the oil or eat the grease under any circumstances, as they can cause vomiting and diarrhoea.
Keep the oil out of the reach of children.

Maintenance and inspection

-  Maintenance and inspection of the sewing machine should only be carried out by a qualified technician.
-  Ask your Brother dealer or a qualified electrician to carry out any maintenance and inspection of the electrical system.
-  Turn off the power switch and disconnect the power cord from the wall outlet at the following times, otherwise the machine may operate if the foot switch is depressed by mistake, which could result in injury.
 - When carrying out inspection, adjustment and maintenance
 - When replacing consumable parts such as the rotary hook
-  If the power switch needs to be left on when carrying out some adjustment, be extremely careful to observe all safety precautions.
-  Hold the machine head with both hands when tilting it back or returning it to its original position.
Furthermore, after tilting back the machine head, do not push the face plate side or the pulley side from above, as this could cause the machine head to topple over, which may result in personal injury or damage to the machine.
-  Use only the proper replacement parts as specified by Brother.
-  If any safety devices have been removed, be absolutely sure to re-install them to their original positions and check that they operate correctly before using the machine.
-  Any problems in machine operation which result from unauthorized modifications to the machine will not be covered by the warranty.

3. Warning labels

The following warning labels appear on the sewing machine.

Please follow the instructions on the labels at all times when using the machine. If the labels have been removed or are difficult to read, please contact your nearest Brother dealer.

1

	▲ 危険		▲ 危険	
	▲ DANGER		▲ PELIGRO	

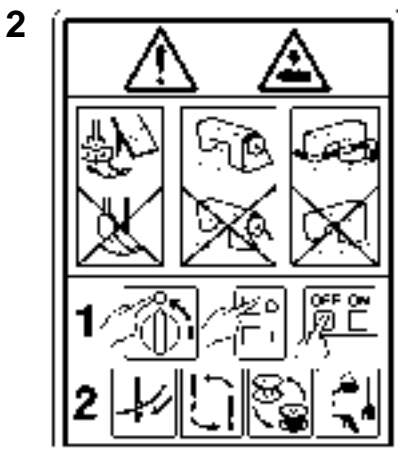

CAUTION
Moving parts may cause injury.

Operate with safety devices* installed.

Turn off the power before carrying out operations such as threading, changing the needle, bobbin knives or hook cleaning and adjusting.

*Safety devices
Eye guard
Finger guard
DT solenoid cover
Thread take-up cover
Side cover
Rear cover, etc.



Be careful to avoid injury from the moving thread take-up.



Be careful not to get your hands caught when returning the machine head to its original position after it has been tilted.

5 **PE** Be sure to connect the ground. If the ground connection is not secure, you run a high risk of receiving a serious electric shock, and problems with correct operation may also occur.

6 Direction of operation



Do not hold, otherwise problems with operation or injury may occur.

8

brother
Lubricating Oil for Sewing

▲ CAUTION

Lubricating oil may cause inflammation of the skin.

Wear protective glasses and gloves.

Avoid breathing of oil fumes and avoid contact with eyes.

Do not swallow.

Keep away from children.

FIRST AID

SKIN: Wash with plenty of water.

EYES: Flush with plenty of water.

INHALATION: Move to a well-ventilated area.

INGESTION: Do not induce vomiting.

Thread take-up cover

Eye guard

Finger guard

3162B

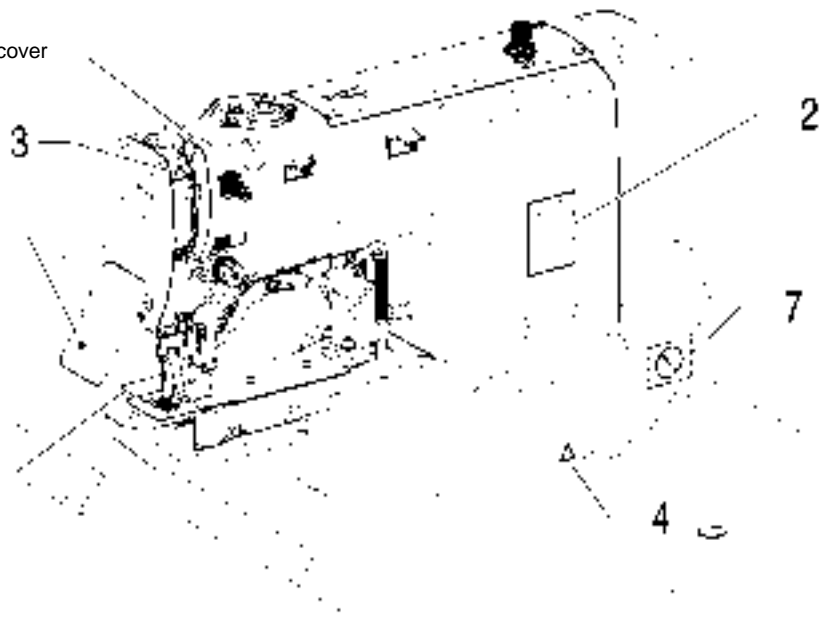

Rear cover

6

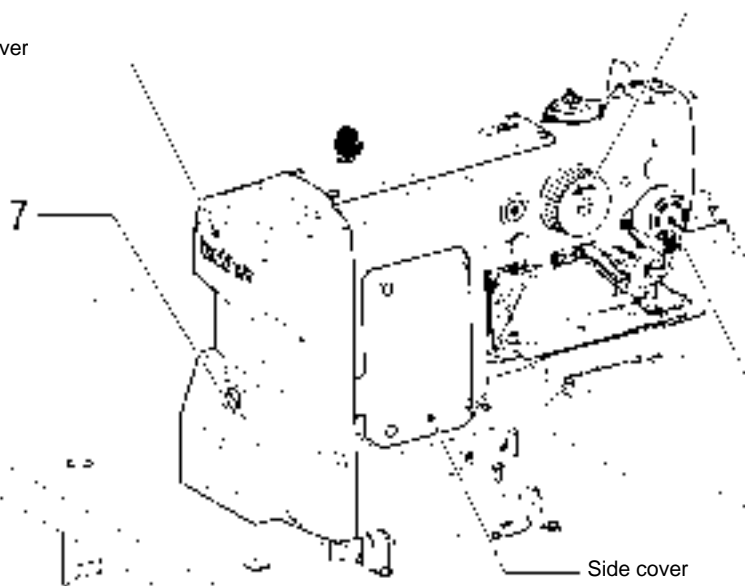

DT solenoid cover

Side cover

5

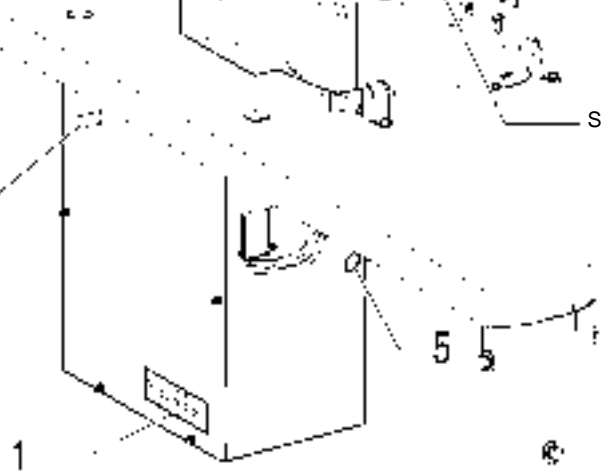

1

8



Oil tank

2506B

3163B

CONTENTS

1. NAMES OF MAJOR PARTS	1	5. USING THE OPERATION PANEL (BASIC OPERATIONS).....	34
2. SPECIFICATIONS	2	5-1. Name and function of each operation panel item	34
2-1. Machine specifications	2	5-2. Program setting method.....	36
2-2. List of Sewing Patterns (KE-430FX·FS)	3	5-3. Copying programs.....	40
2-3. List of Sewing Patterns (BE-438FX).....	8	5-4. Checking the sewing pattern (KE-430FX·FS).....	41
3. INSTALLATION	11	5-5. Checking the sewing pattern (BE-438FX)	42
3-1. Table processing diagram	11	5-6. Correcting the upper thread tension <For KE-430FX and BE-438FX>	43
3-2. Installing the control box.....	12	6. USING THE OPERATION PANEL (ADVANCED OPERATIONS).....	44
3-3. Installing the oiler.....	12	6-1. Setting memory switches	44
3-4. Installing the machine head.....	13	6-2. List of memory switches.....	45
3-5. Installing the operation panel	14	6-3. Using the lower thread counter	47
3-6. Installing the cotton stand.....	15	6-4. Using the production counter	48
3-7. Installing the button tray (BE-438FX)	15	6-5. Using cycle programs	49
3-8. Installing the eye guard	15	6-6. Direct selection	53
3-9. Connecting the cords.....	16	6-7. Resetting all settings to their defaults	54
3-10. Connecting the ground wire	19	7. SEWING	55
3-11. Installing the rear cover	20	7-1. Sewing	55
3-12. Lubrication	21	7-2. Changing sewing conditions	56
3-13. Connecting the power cord	22	8. MAINTENANCE.....	57
3-14. Checking the machine head switch.....	25	8-1. Cleaning the rotary hook.....	57
3-15. Starting up	25	8-2. Cleaning the control box air inlet ports	58
4. PREPARATION BEFORE SEWING.....	26	8-3. Draining the oil	58
4-1. Installing the needle.....	26	8-4. Cleaning the eye guard.....	58
4-2. Threading the upper thread.....	26	8-5. Checking the needle	58
4-3. Winding the lower thread.....	28	8-6. Lubrication.....	58
4-4. Installing the bobbin case	29	8-7. Applying grease (Work clamp: KE-430 FX·FS).....	59
4-5. Thread tension.....	29	8-8. Applying grease (When “GREASEUP” appears).....	59
4-5-1. Lower thread tension	29		
4-5-2. Upper thread tension.....	30		
4-6. Thread nipper device <KE-430FX-03, -0K, -0F>.....	31		
4-7. Inserting the button (BE-438FX).....	33		
4-8. Adjusting the button clamp (BE-438FX)	33		
4-9. Installing the accessory spring (BE-438FX) ...	33		

9. STANDARD ADJUSTMENT	63
9-1. Standard thread tension	63
9-1-1. Upper and lower thread tension.....	63
9-1-2. Thread take-up spring.....	64
9-1-3. Arm thread guide C.....	65
9-1-4. Needle bar bush thread guide D.....	65
9-2. Adjusting the needle bar height.....	65
9-3. Adjusting the needle bar lift amount and the driver needle guard.....	66
9-4. Adjusting the needle clearance	66
9-5. Adjusting the shuttle race thread guide	67
9-6. Rotary hook lubrication amount.....	67
9-7. Replacing the movable knife and fixed knife..	68
9-8. Adjusting the work clamp lift amount (KE-430 FX·FS)	69
9-9. Adjusting the button clamp lift amount (BE-438FX).....	69
9-10. Adjusting the holding pressure (BE-438FX).....	70
9-11. Adjusting the position of the button clamp (BE-438FX).....	70
9-12. Adjusting the thread wiper	70
9-13. Checking the machine head switch.....	71
10. TABLE OF ERROR CODES	72
11. TROUBLESHOOTING	76
12. 7-SEGMENT DISPLAY LIST	79

1. NAMES OF MAJOR PARTS

3164B

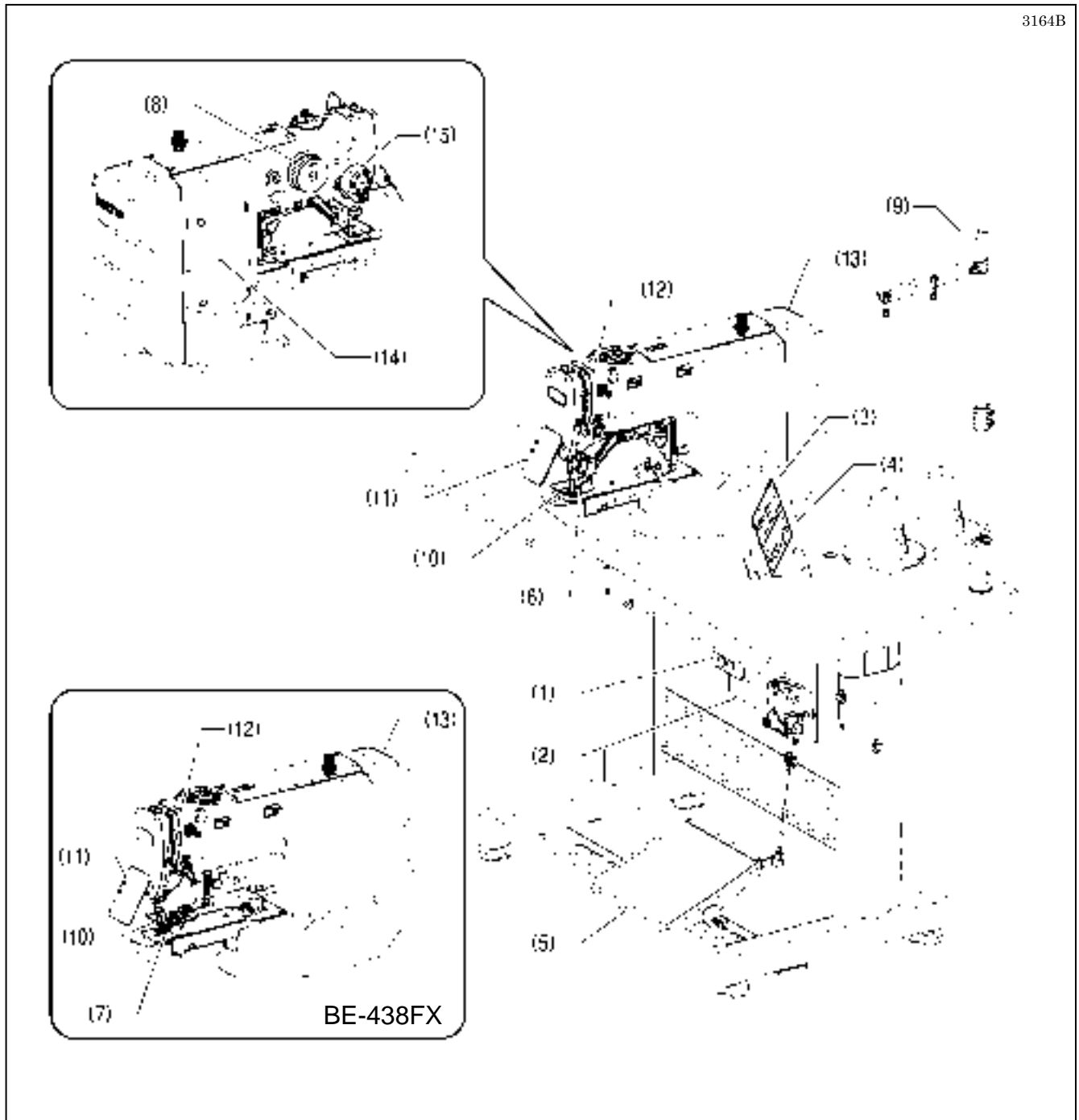

- (1) Power switch
- (2) Control box
- (3) SD card slot
- (4) Operation panel
- (5) Foot switch
- (6) Work clamp (KE-430FX·FS)
- (7) Button clamp (BE-438FX)
- (8) Pulley
- (9) Cotton stand

- Safety devices**
- (10) Finger guard
 - (11) Eye guard
 - (12) Thread take-up cover
 - (13) Rear cover
 - (14) Side cover
 - (15) DT solenoid cover

2. SPECIFICATIONS

2-1. Machine specifications



- 3 Medium-weight materials
- 5 Heavy-weight materials
- K Knitted materials
- F Functional garments



- 3 Medium-weight materials
- 5 Heavy-weight materials

3187B

	KE-430FX	KE-430FS	BE-438FX
	Electronic direct drive lockstitch bar tacker		Electronic direct drive lockstitch button sewer
Stitch formation	Single needle lock stitch		
Maximum sewing speed	3,200 sti/min		2,700 sti/min
Pattern size (X x Y)	40 x 30 mm max.		6.4 x 6.4 mm max.
Dimensions of buttons that can be sewn			Outer diameter of button 8 - 30 mm (*1)
Feed mechanism	Y-θ intermittent feed mechanism (pulse-motor driven mechanism)		
Stitch length	0.05 - 12.7 mm		0.05 - 6.4 mm
Number of stitches	Refer to “List of Sewing Patterns” for the number of stitches in sewing patterns which have already been entered.		
Maximum stitch number	Approx. 5,000 stitches (1 pattern)		
Work clamp lifter	Pulse-motor driven mechanism		
Work clamp height Button clamp height	17 mm max.		13 mm max.
Hook	Shuttle hook (shuttle hook 2, optional)		Shuttle hook
Lubrication method	Semi dry	Minimum lubrication	Semi dry
Digital tension set	Standard equipment	Option	Standard equipment
Thread wiper device	Standard equipment		
Thread trimmer device	Standard equipment		
Thread nipper device	-03, -0K, -0F specifications: Standard equipment; -05 specifications: Option	3,5 specifications: option	Option
Data storage method	Flash memory (Any sewing pattern can be added using SD card) (*2)		
Data recording media	SD card (*2)		
Number of cycle programs	Up to 30 can be registered (up to 50 steps each)		
Number of stored data	89 sewing patterns are set already		64 sewing patterns are set already
	(Up to a maximum of 512 additional types of sewing patterns. Total number of stitches of stored data which can be added is within 500,000.) (*3)		
Motor	AC servo motor 550 W		
Weights	Machine head: approx. 57 kg, Operation panel: approx. 0.4 kg Control box: 9 kg		
Power source	Single-phase 100V / 220V, 3-phase 220V / 380V / 400V (For single-phase 100 V and three-phase 380 V/400 V, the trans box is required.)		

*1 Use the optional button clamp B (S03634-101) for diameters of 20 mm or greater.

*2 No guarantees of operation can be given for any media.

*3 The number of sewing patterns and the number of stitches that can be recorded will vary depending on the number of stitches in each sewing pattern.

2. SPECIFICATIONS

2-2. List of Sewing Patterns (KE-430FX·FS)

The sewing patterns shown below have been preset into the sewing machine and can be selected according to specifications. (Any sewing pattern is available as long as it is within the work clamp and feed plate in size.)

Use the work clamp and feed plate that match the respective sewing pattern selected.

The sewing size is the length when the enlargement/reduction ratio is 100%.











For medium-weight materials (-03)									
No.	Pattern	No. of stitches	Tacking size (mm)		No.	Pattern	No. of stitches	Tacking size (mm)	
			Length	Width				Length	Width
1		42	16	2	65		43	16	2
4		31	16	2	66		32	16	2
5		29	10	2	67		30	10	2
8		21	7	2	68		22	7	2
13		35	10	2	69		36	10	2
15		42	10	2	70		43	10	2
20		28	7	2	71		29	7	2
21		35	7	2	72		36	7	2
64		30	16	2	89		90	24	3
For heavy-weight materials (-05)									
No.	Pattern	No. of stitches	Tacking size (mm)		No.	Pattern	No. of stitches	Tacking size (mm)	
			Length	Width				Length	Width
2		42	20	3	18		56	24	3
3		35	20	3	19		64	24	3
6		30	16	3	62		42	20	3
14		35	16	3	63		35	20	3
16		43	16	3	78		43	20	3
17		42	24	3	79		36	20	3





For heavy-weight materials (-05)									
No.	Pattern	No. of stitches	Tacking size (mm)		No.	Pattern	No. of stitches	Tacking size (mm)	
			Length	Width				Length	Width
80		31	16	3	83		43	24	3
81		36	16	3	84		57	24	3
82		44	16	3	85		65	24	3
For knitted materials (-0K) and foundation garments (-0F)									
No.	Pattern	No. of stitches	Tacking size (mm)		No.	Pattern	No. of stitches	Tacking size (mm)	
			Length	Width				Length	Width
7		28	8	2	73		29	8	2
9		21	7	2	74		22	7	2
22		14	7	2	75		15	7	2
31*		28	8	2	76*		29	8	2
32*		22	8	2	77*		23	8	2
33*		15	8	2					

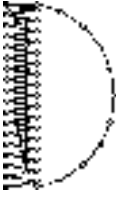

* The sewing start and sewing end are in the middle of the pattern.

Straight bar tacking					Vertical zigzag stitching				
No.	Pattern	No. of stitches	Tacking size (mm)		No.	Pattern	No. of stitches	Tacking size (mm)	
			Length	Width				Length	Width
10		21	10	0.3	44		46	9	15
11		28	10	0.3					
12		28	20	0.3	45		70	9	25
23		35	25	0.3					
24		42	25	0.3					
25		45	25	0.3					







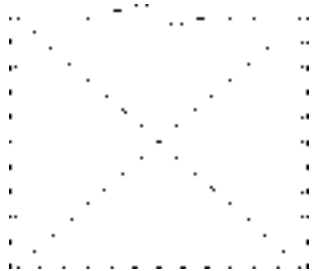





2. SPECIFICATIONS

Vertical bar tacking					Vertical straight bar tacking				
No.	Pattern	No. of stitches	Tacking size (mm)		No.	Pattern	No. of stitches	Tacking size (mm)	
			Length	Width				Length	Width
26		28	3	10	28		19	0.3	10
27		35	3	10	29		21	0.3	10
40		32	3	16	30		28	0.3	10
41		36	3	16	46		27	0.3	20
42		44	3	20	47		44	0.3	25
43		68	3	24					

Crescent bar tacking									
No.	Pattern	No. of stitches	Tacking size (mm)		No.	Pattern	No. of stitches	Tacking size (mm)	
			Length	Width				Length	Width
34		35	12	7	37		57	7	12
35		58	12	7	38		53	7	10
36		57	7	12	39		53	7	10

Crossed stitching					Crossed tacking				
No.	Pattern	No. of stitches	Tacking size (mm)		No.	Pattern	No. of stitches	Tacking size (mm)	
			Length	Width				Length	Width
48		70	10	10	50		84	16	16
49		93	9.6	9.6	51		105	30	26

2. SPECIFICATIONS

L-pattern tacking									
No.	Pattern	No. of stitches	Tacking size (mm)		No.	Pattern	No. of stitches	Tacking size (mm)	
			Length	Width				Length	Width
52		60	11.3	11.2	53		60	11.3	11.2
54		78	15.3	15.2	55		78	15.3	15.2
Circular stitching									
No.	Pattern	No. of stitches	Tacking size (mm)		No.	Pattern	No. of stitches	Tacking size (mm)	
			Length	Width				Length	Width
56		106	9	9	59		104	10	10
57		116	9	9	60		114	10	10
58		127	9	9	61		124	10	10
For eyelet buttonhole									
No.	Pattern	No. of stitches	Tacking size (mm)						
			Length	Width					
86		21	6	2					
87		28	6	2					
88		35	6	2					

If you want to sew a sewing pattern other than standard sewing patterns, you can create your original pattern using the PS-300B. Consult with your local Brother sales office for details.





Note when creating additional sewing patterns

When sewing data with a small number of stitches (15 stitches or less) is sewn repeatedly (short cycle operation), the upper shaft motor may overheat and the "E150" error code may be generated.

2-3. List of Sewing Patterns (BE-438FX)

The sewing patterns shown below have been preset into the sewing machine. Any sewing pattern can be selected as long as the needle will drop down into the holes of the buttons.

When sewing patterns that do not have crossover stitches, the thread is trimmed after sewing of one side is completed, and then the other side is sewn.





No.	No. of holes in button	Pattern	No. of threads	No. of crossover stitches	No. of stitches	Sewing size (mm)				
						X	Y			
1	2		6	—	12	3.4	0			
54 ^{*1}			6	—	12					
2			8	—	14					
55 ^{*1}			8	—	14					
3			10	—	16					
4			12	—	18					
5 ^{*2}			16	—	22					
6 ^{*2}			20	—	26					
56 ^{*1}				6	—			11	0	3.4
7 ^{*3}				6	—			12		
23 ^{*3}	10	—		16						
8 ^{*3}	12	—		18						
9 ^{*3}	3		5-5-5	—	21	2.6	2.4			
24 ^{*3}			7-7-7	—	27					
25 ^{*3}			5-5-5	—	21					
26 ^{*3}			7-7-7	—	27					
57 ^{*1}	4		6-6	1	18	3.4	3.4			
10			6-6	1	19					
58 ^{*1}			8-8	1	22					
11			8-8	1	23					
12			8-8	3	25					
13			10-10	1	27					
27			12-12	1	31					

*1 Use for buttons with small holes.

*2 Check that the diameter of the holes in the buttons is 2 mm or greater before using the programs.

*3 Do not use the button lifter spring.

2. SPECIFICATIONS



No.	No. of holes in button	Pattern	No. of threads	No. of crossover stitches	No. of stitches	Sewing size (mm)	
						X	Y
14	*4		6-6	0	24	3.4	3.4
36	*5		6-6	0	24		
28	*4		8-8	0	28		
37	*5		8-8	0	28		
15	*4		10-10	0	32		
38	*5		10-10	0	32		
29	*4		12-12	0	36		
39	*5		12-12	0	36		
59	*1			6-5	1		
16		6-5		1	18		
60	*1	8-7		1	21		
17		8-7		1	22		
30		10-9		1	26		
61	*1		6-6	1	18		
18			6-6	1	19		
62	*1		8-8	1	22		
19			8-8	1	23		
63	*1		10-10	1	26		
31			10-10	1	27		
45			12-12	1	31		
20	*4		6-6	0	24		
40	*5		6-6	0	24		
32	*4		8-8	0	28		
41	*5		8-8	0	28		
33	*4		10-10	0	32		
42	*5		10-10	0	32		

*1 Use for buttons with small holes.

*4 When sewing of one side is completed, the button clamp rises and the thread is trimmed. To finish sewing, press the foot switch until sewing of the other side starts, or press the foot switch again after sewing of the other side is completed.

*5 When sewing of one side is completed, the thread will be trimmed without the button clamp rising, and then the other side will be sewn.

2. SPECIFICATIONS

No.	No. of holes in button	Pattern	No. of threads	No. of crossover stitches	No. of stitches	Sewing size (mm)	
						X	Y
64	*1		6-6	1	18	3.4	3.4
21	*3		6-6	1	19	2.4	
34	*3		10-10	1	27		
22	*3*4		6-6	0	24		
43	*3*5		6-6	0	24		
35	*3*4		10-10	0	32		
44	*3*5		10-10	0	32		
46			6-7	1	19	3.4	
47			8-9	1	23		
48			10-11	1	27		
49			12-13	1	31		

*1 Use for buttons with small holes.

*3 Do not use the button lifter spring.

*4 When sewing of one side is completed, the button clamp rises and the thread is trimmed. To finish sewing, press the foot switch until sewing of the other side starts, or press the foot switch again after sewing of the other side is completed.

*5 When sewing of one side is completed, the thread will be trimmed without the button clamp rising, and then the other side will be sewn.









For shank button					
No.	Pattern	No. of threads	No. of stitches	Sewing size (mm)	
				X	Y
50		6	12	3.4	0
51		8	14		
52		10	16		
53		12	18		

Note when creating additional sewing patterns

When sewing data with a small number of stitches (15 stitches or less) is sewn repeatedly (short cycle operation), the upper shaft motor may overheat and the "E150" error code may be generated.

3. INSTALLATION

⚠ CAUTION

-  Machine installation should only be carried out by a qualified technician.
-  Contact your Brother dealer or a qualified electrician for any electrical work that may need to be done.
-  The sewing machine head weighs approximately 57 kg. The installation should be carried out by two or more people.
-  Do not connect the power cord until installation is complete, otherwise the machine may operate if the foot switch is depressed by mistake, which could result in injury.
-  Hold the machine head with both hands when tilting it back or returning it to its original position. Furthermore, after tilting back the machine head, do not push the face plate side or the pulley side from above, as this could cause the machine head to topple over, which may result in personal injury or damage to the machine.
-  All cords should be secured at least 25 mm away from any moving parts. Furthermore, do not excessively bend the cable or secure it too firmly staples, otherwise there is the danger that fire or electric shocks could occur.
-  Be sure to connect the ground. If the ground connection is not secure, you run the risk of receiving a serious electric shock, and problems with correct operation may also occur.
-  Install the safety covers to the machine head and motor.

3-1. Table processing diagram

- The thickness of the table should be at least 40 mm, and it should be strong enough to bear the weight and vibration of the sewing machine.
- Check that the control box is at least 10 mm away from the leg. If the control box and the leg are too close together, it may result in incorrect sewing machine operation.

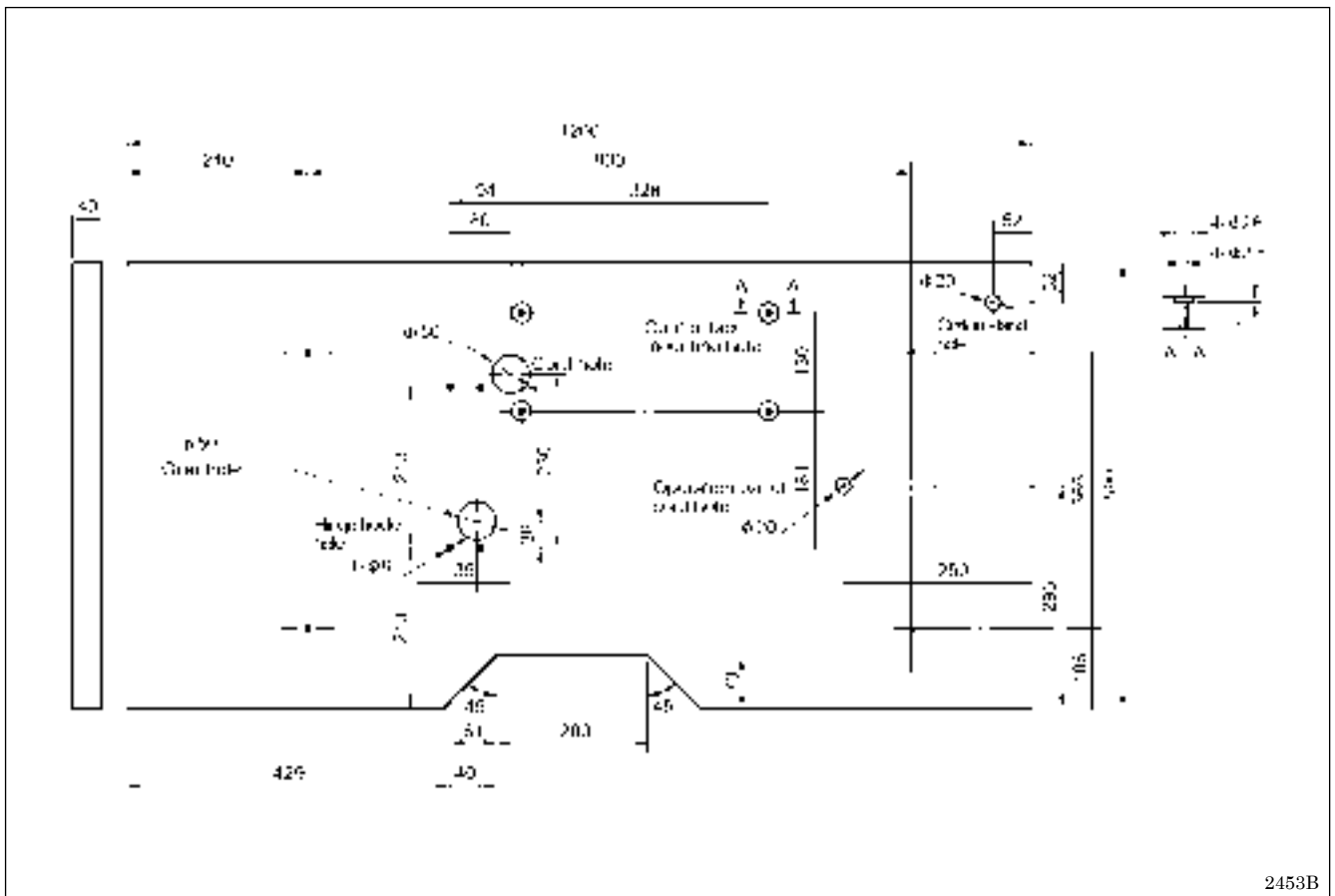

2453B

3-2. Installing the control box

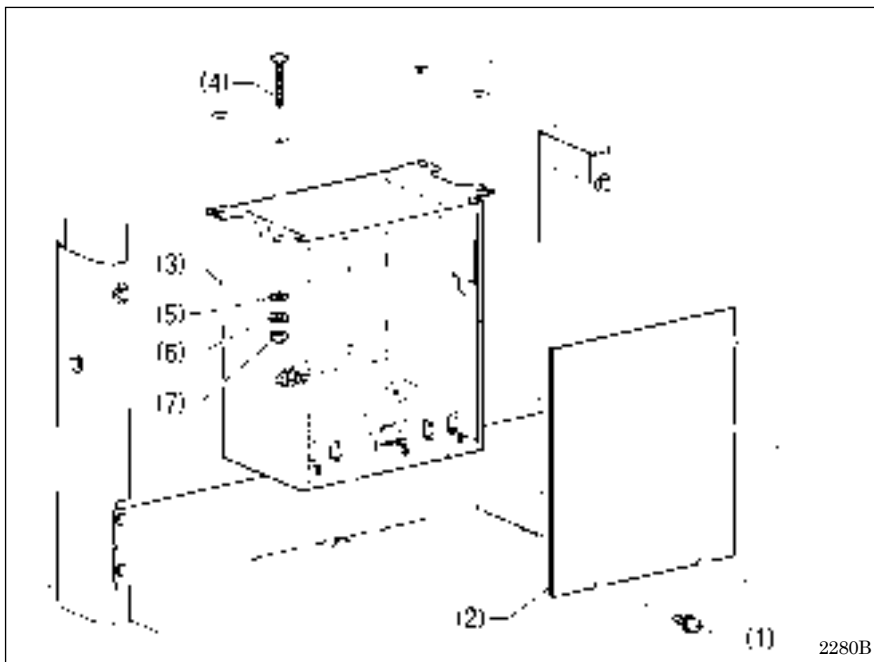

Remove the six screws (1), and then remove the control box cover (2).

- (3) Control box
- (4) Bolts [4 pcs]
- (5) Plain washers [4 pcs]
- (6) Spring washers [4 pcs]
- (7) Nuts [4 pcs]

3-3. Installing the oiler

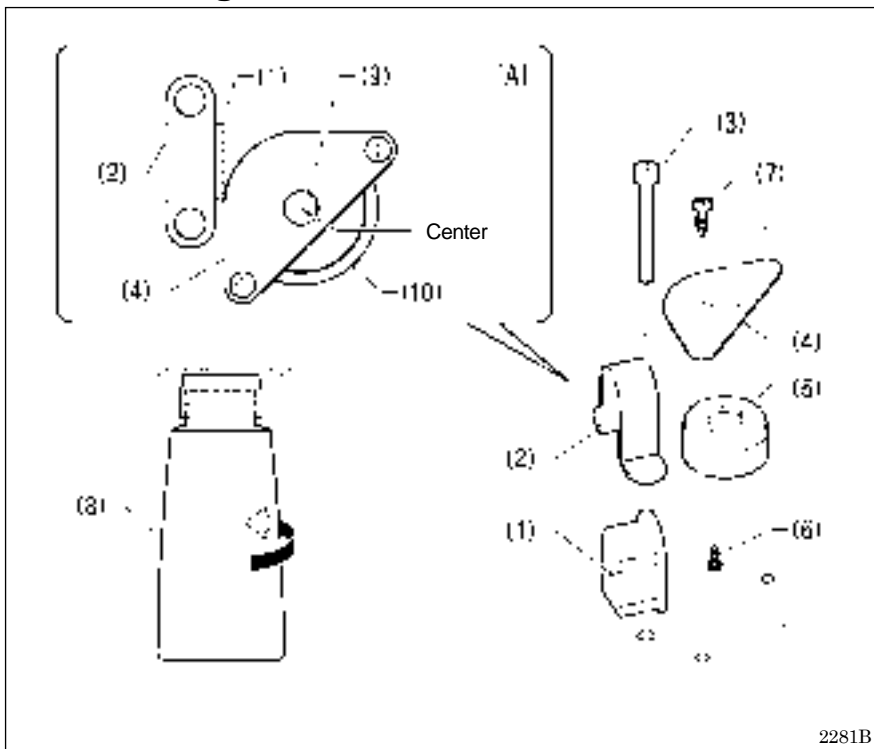

Before installing the oiler, provisionally install the rubber cushion (1) and the hinge holder (2) to the table with the two bolts (3).

- (4) Dust oiler setting plate
- (5) Dust oiler
- (6) Screws [2 pcs]
- (7) Wood screws [2 pcs]
- (8) Oiler

* Install the dust oiler setting plate (4) so that the hole (9) in the dust oiler setting plate (4) is in the center of the hole (10) in the table for installing the oiler (8) as shown in figure [A].

NOTE:

- Make sure that the dust oiler setting plate (4) does not interfere with the hinge holder (2).

3-4. Installing the machine head

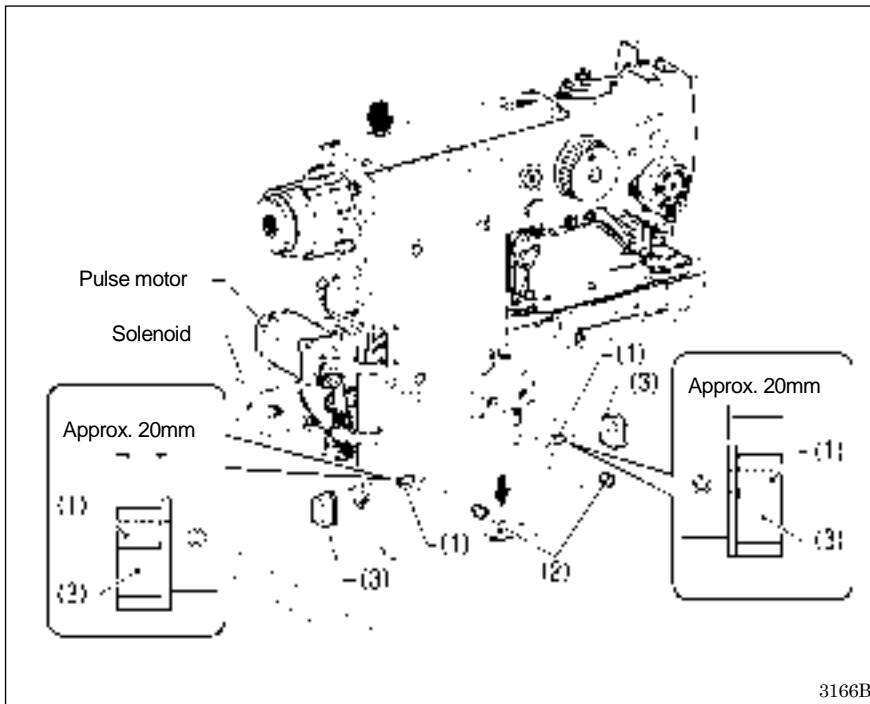

- (1) Pins [2 pcs]
- (2) Set screws [2 pcs]
- (3) Rubber cushion assembly [2 pcs]

Place the machine head gently on top of the table.

NOTE:

- Be careful not to clamp any cords between the machine head and the table.
- When holding the machine head, do not hold it by the pulse motor or the solenoid, otherwise it may damage the pulse motor or solenoid.

3166B

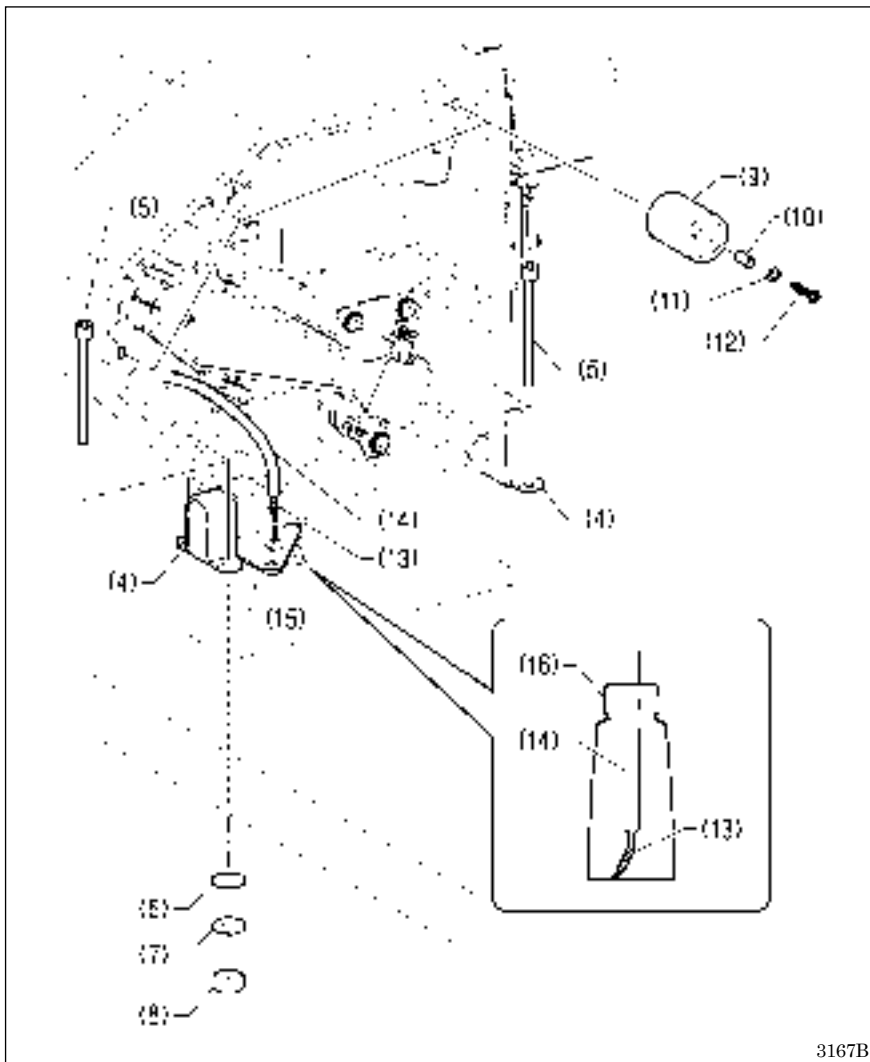

- (4) Hinge holders [2 pcs]
- (5) Bolts [4 pcs]
- (6) Plain washers [4 pcs]
- (7) Spring washers [4 pcs]
- (8) Nuts [4 pcs]
- (9) Rubber cushions [3 pcs]
- (10) Collar [3 pcs]
- (11) Plain washers [3 pcs]
- (12) Screws [3 pcs]
- (13) Felt
- (14) Oil tube

Pass the felt (13) and the oil tube (14) through the hole in the dust oiler setting plate (15) into the oiler (16).

3167B

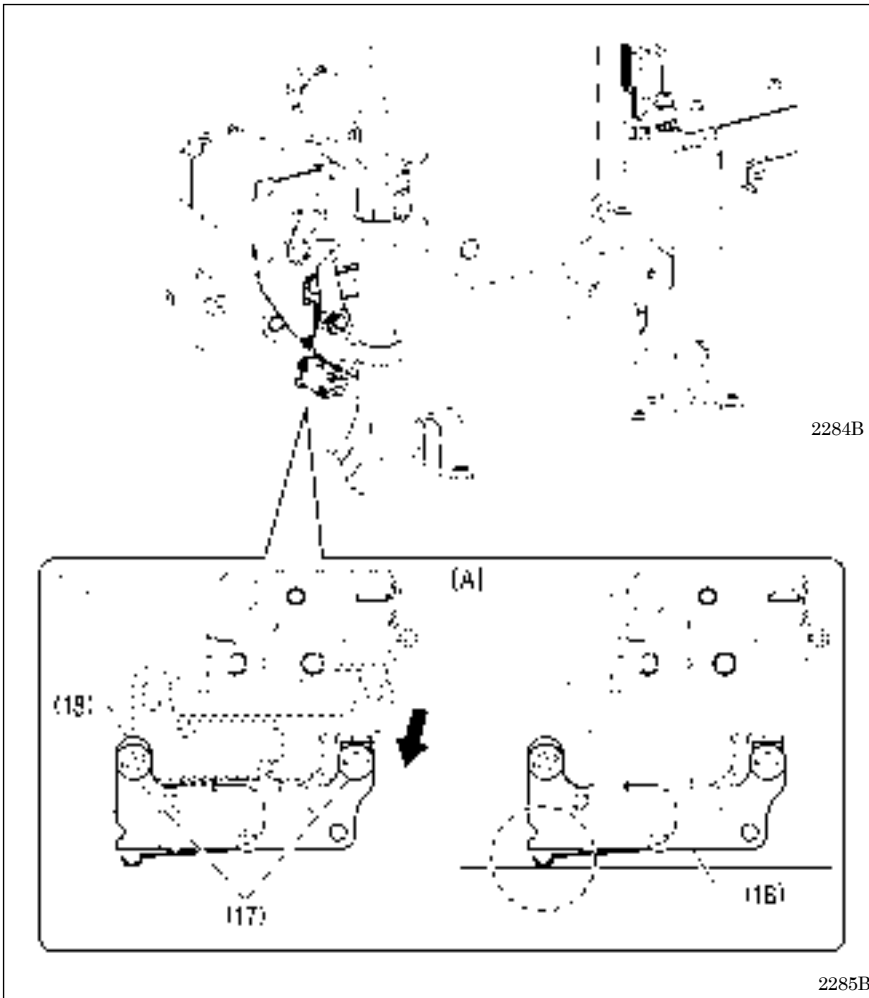

1. Remove the two screws (17), and then temporarily remove the machine head switch (18).
2. Use the two screws (17) which were removed to install the machine head switch (18) in the position shown in the illustration.
3. Check that the machine head switch is turned on as shown in figure [A].

* If the machine head switch is not turned on, adjust the installation position while referring to "3-14. Checking the machine head switch".

3-5. Installing the operation panel

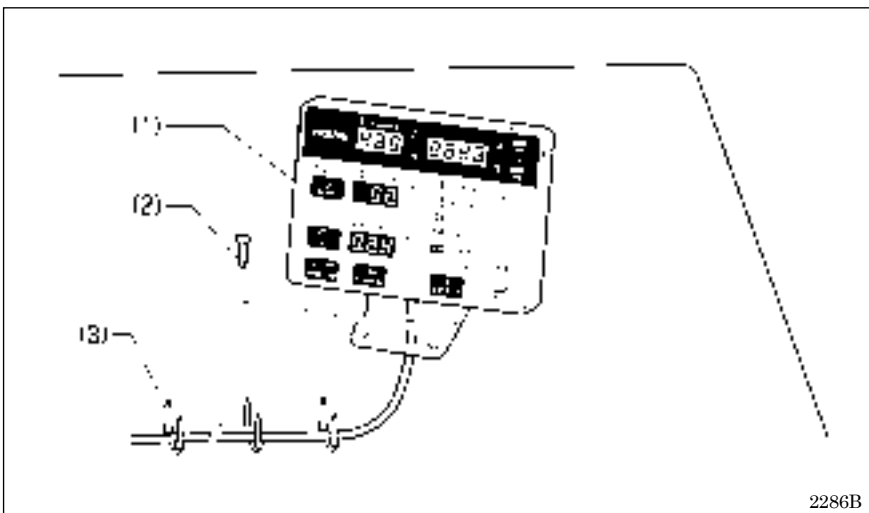

- (1) Operation panel
- (2) Wood screws [4 pcs]

* Pass the panel cord through the hole in the table, and then insert it into the control box through the hole in the side of the control box.

- (3) Staples [3 pcs]

3-6. Installing the cotton stand

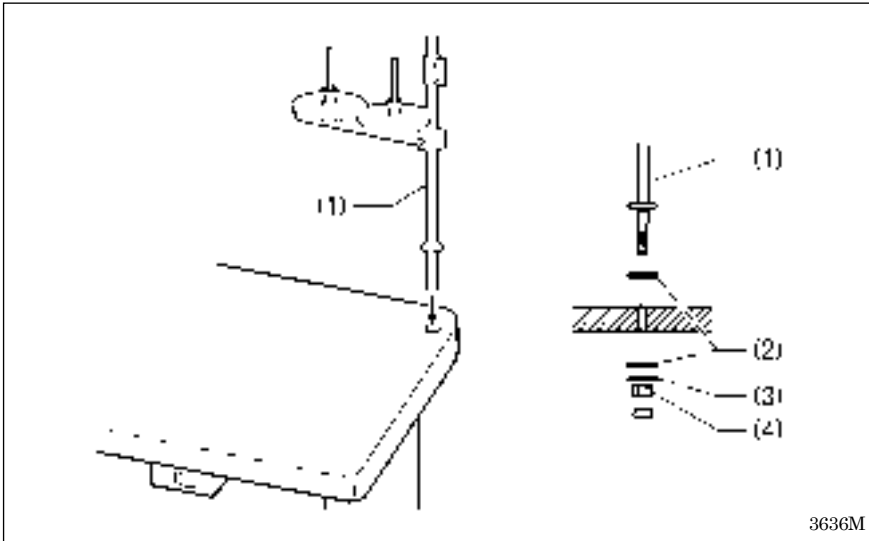

(1) Cotton stand

NOTE:

Securely tighten the nut (4) so that the two rubber cushions (2) and the washer (3) are securely clamped and so that the cotton stand (1) does not move.

3-7. Installing the button tray (BE-438FX)

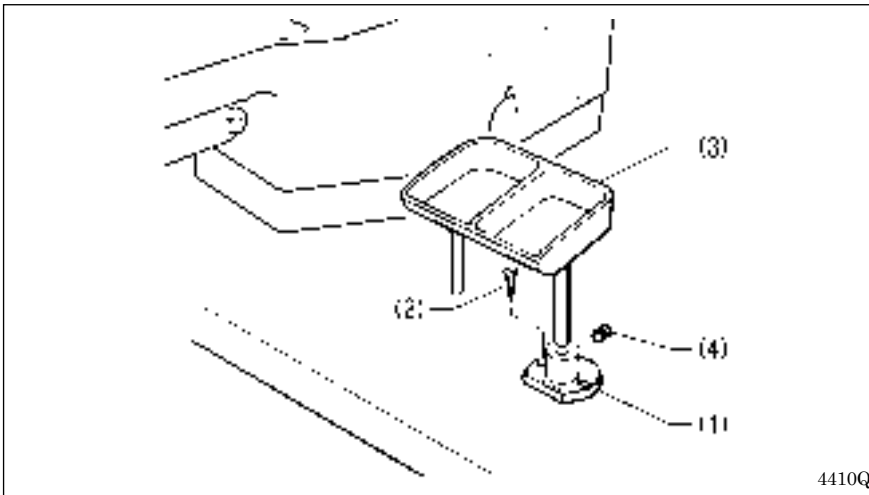

Install the button tray at a place convenient for operation.

- (1) Button tray holder
- (2) Wood screws [2 pcs]
- (3) Button tray
- (4) Set screw

3-8. Installing the eye guard

CAUTION



Attach all safety devices before using the sewing machine.
If the machine is used without these devices attached, injury may result.

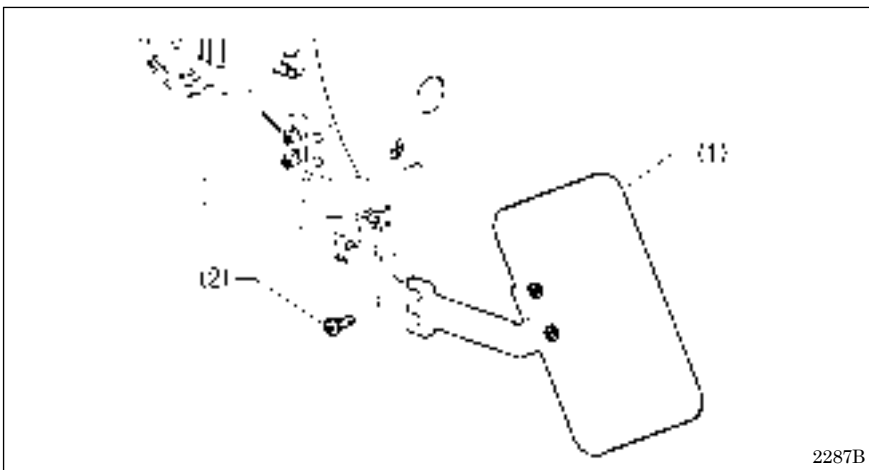

- (1) Eye guard assembly
- (2) Screws [2 pcs]

3-9. Connecting the cords

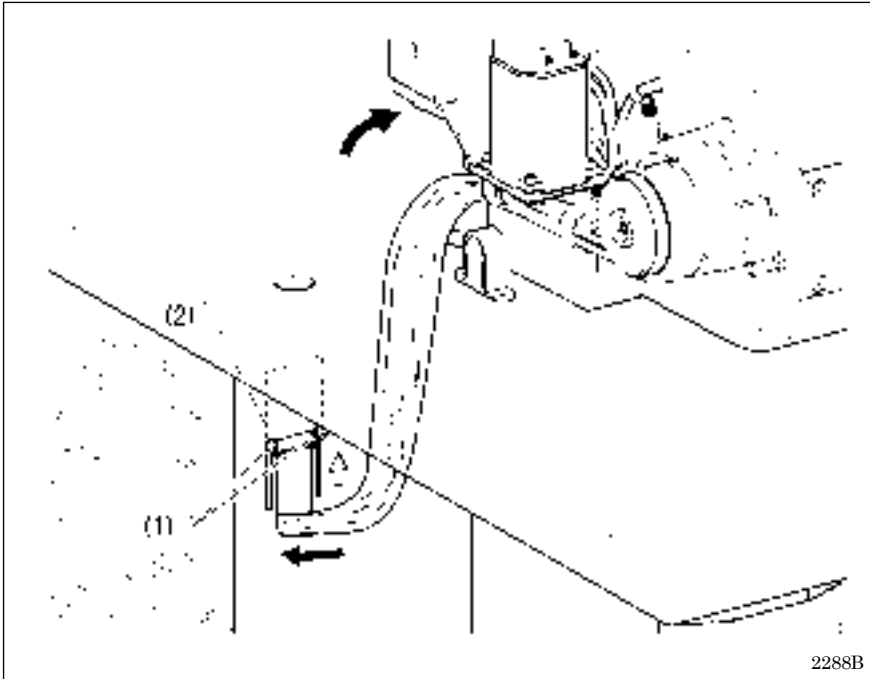

1. Gently tilt back the machine head.
2. Pass the cord bundle through the hole in the work table.
3. Loosen the two screws (1), and then open the cord presser plate (2) in the direction of the white arrow and pass the cord bundle through the opening.
4. Securely connect the connectors as indicated in the table below.
(Refer to following page.)

NOTE:

- Check that the connector is facing the correct way, and then insert it firmly until it locks into place.
- Secure the cables with cable ties and cord clamps, while being careful not to pull on the connector.

(Continued on next page.)

3. INSTALLATION

< Main P. C. board >

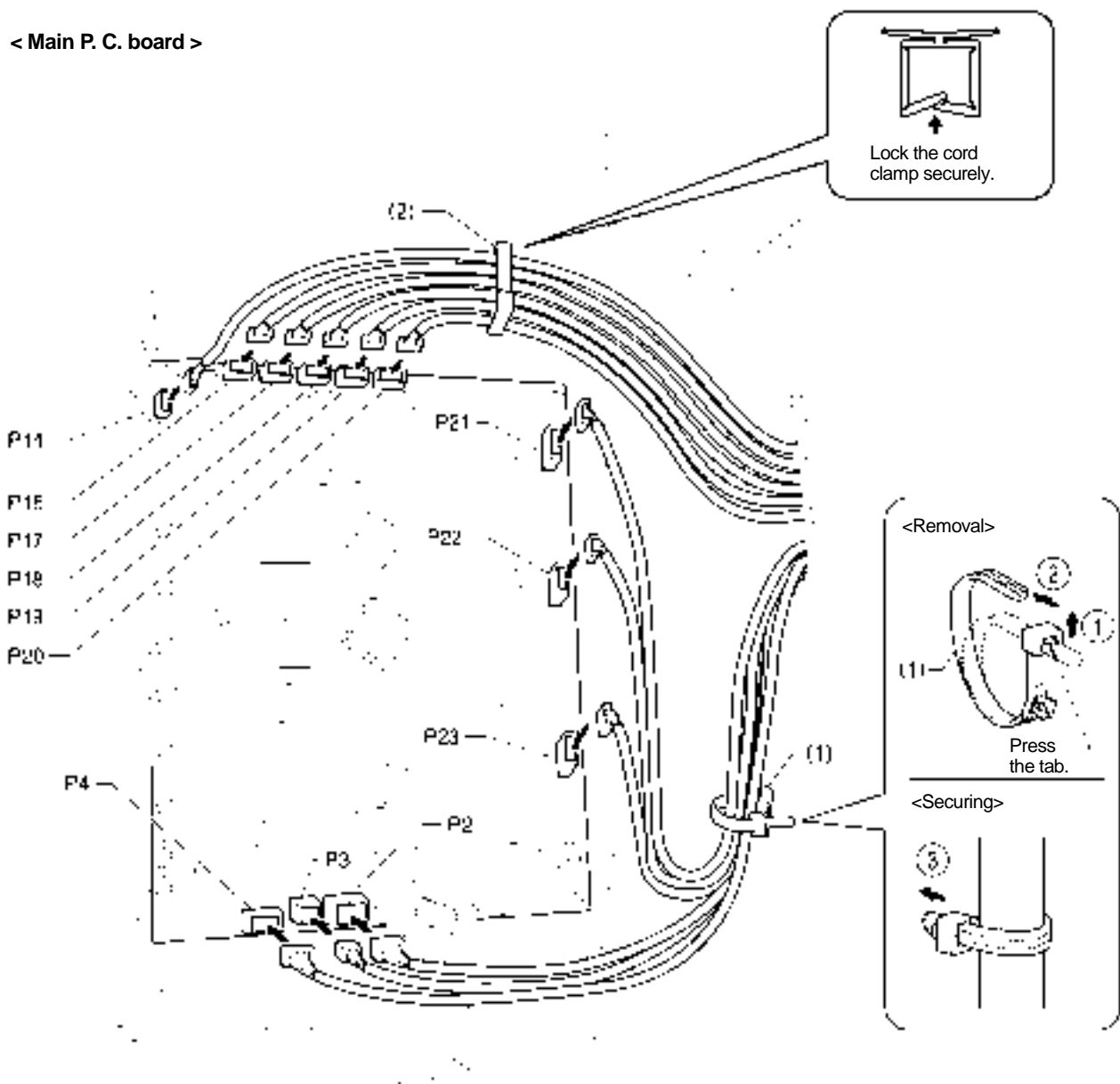

2289B

Connectors	Connection location on main P. C. board	Cord clamps
X pulse motor encoder [5-pin] White	P17 (X-ENC)	(2)
Y pulse motor encoder [5-pin] Blue	P18 (Y-ENC)	(2)
Work clamp pulse motor encoder 5-pin Black	P19 (P-ENC)	(2)
Thread nipper pulse motor encoder 5-pin Red	P20 (T-ENC)	(2)
Machine head switch [3-pin]	P14 (HEAD-SW)	(2)
Machine head memory [6-pin]	P16 (HEAD-M)	(2)
Thread trimmer solenoid [6-pin]	P2 (SOL1)	(1)
Digital tension 4-pin /Tension release solenoid 4 -pin	P3 (SOL2)	(1)
Thread clamp pulse motor [4-pin] Red	P4 (TPM)	(1)
X pulse motor [4-pin] White	P21 (XPM)	(1)
Y pulse motor [4-pin] Blue	P22 (YPM)	(1)
Work clamp pulse motor [4-pin] Black	P23 (PPM)	(1)

NOTE: Route the X, Y and work clamp pulse motor harnesses so that they do not touch the power supply P.C. board.

< Motor P. C. board >

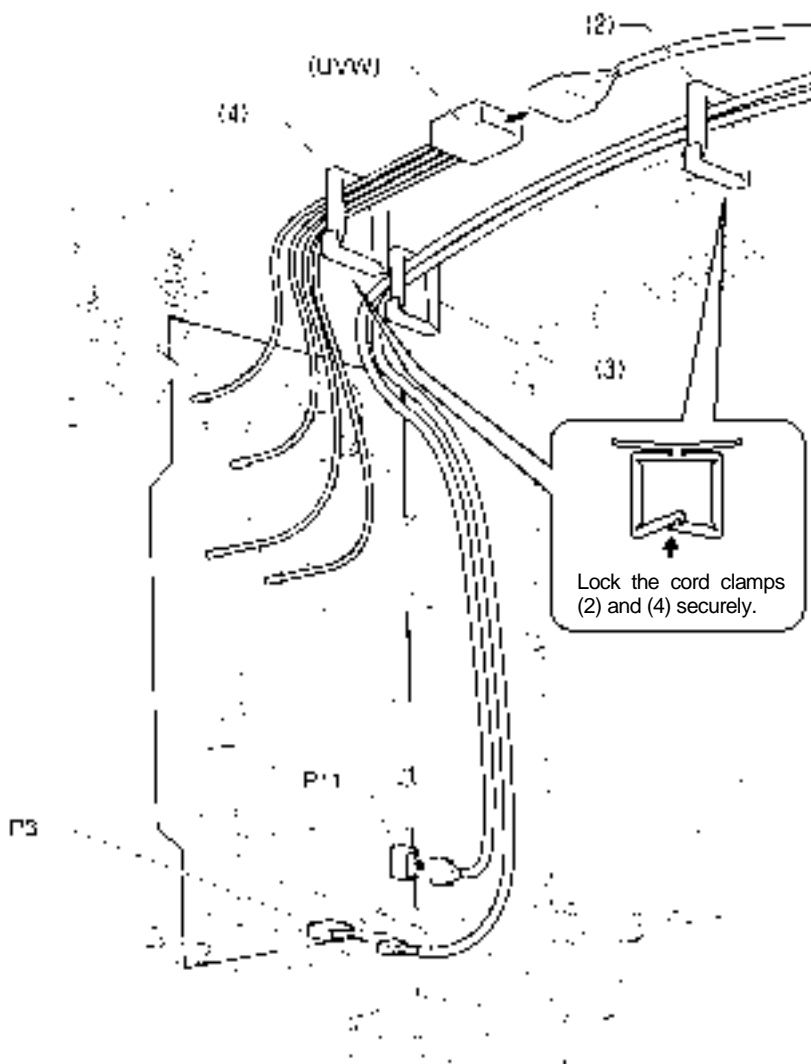

2290B

Connectors	Connection location on motor P. C. board	Cord clamps/ cable ties
Upper shaft motor [4-pin]	(UVW)	(4)
Synchronizer [10-pin]	P11 (SYNC)	(2) (3)
Operation panel [4-pin]	P3 (PANEL)	(2) (3)

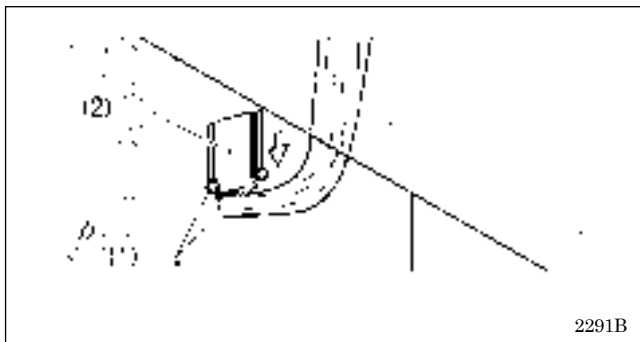

- Close the cord presser plate (2) in the direction of the white arrow, and secure it by tightening the two screws (1).

NOTE:

Close the cord presser plate (2) securely so that no foreign objects, insects or small animals can get inside the control box.

- Check that the cords do not get pulled, and then gently return the machine head to its original position.

3-10. Connecting the ground wire

CAUTION



Be sure to connect the ground. If the ground connection is not secure, you run the risk of receiving a serious electric shock, and problems with correct operation may also occur.

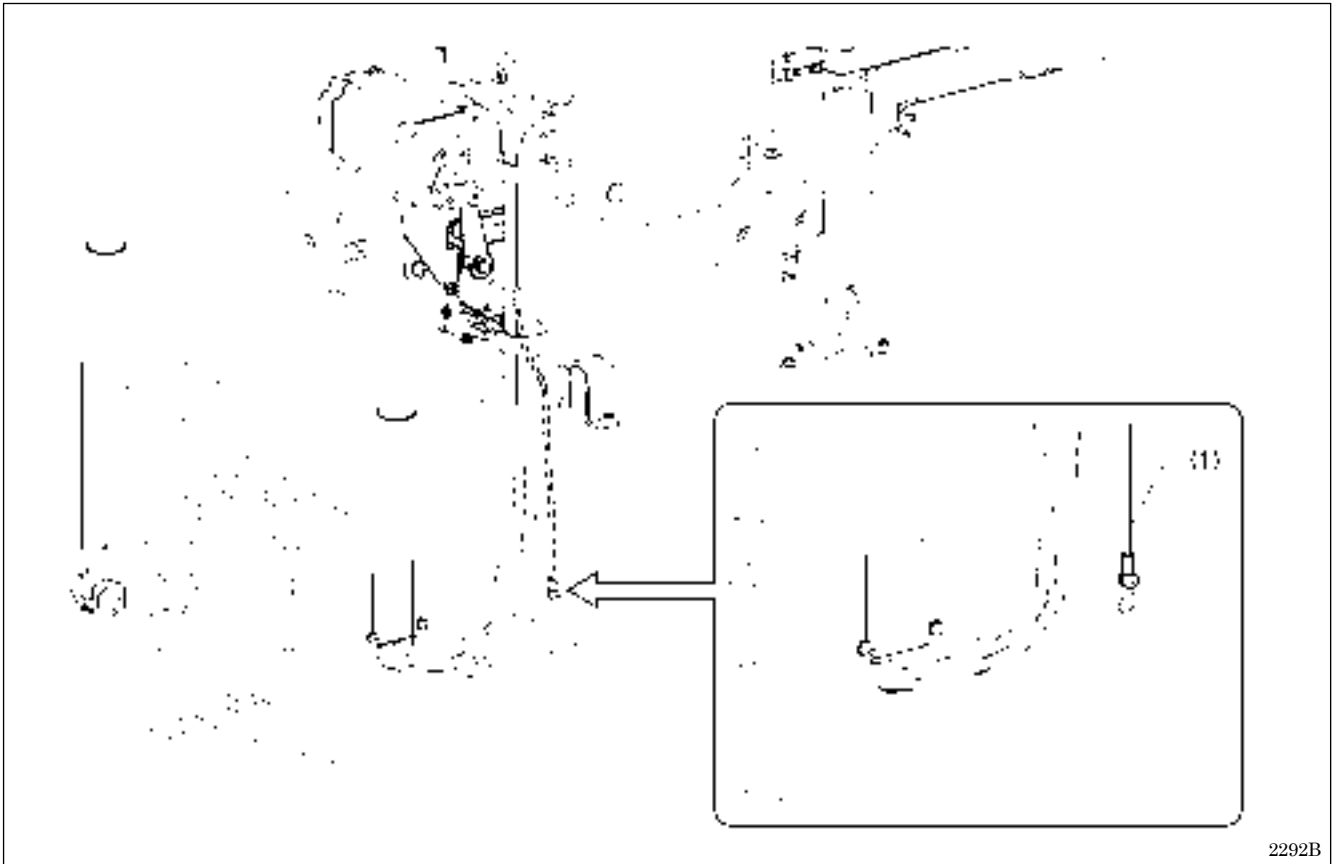

(1) Ground wire from the machine head (Ground mark position)

* The recommended tightening torque for the ground screws is 1.0 ± 0.1 N·m.

NOTE:

Make sure that the ground connections are secure in order to ensure safety.

3-11. Installing the rear cover

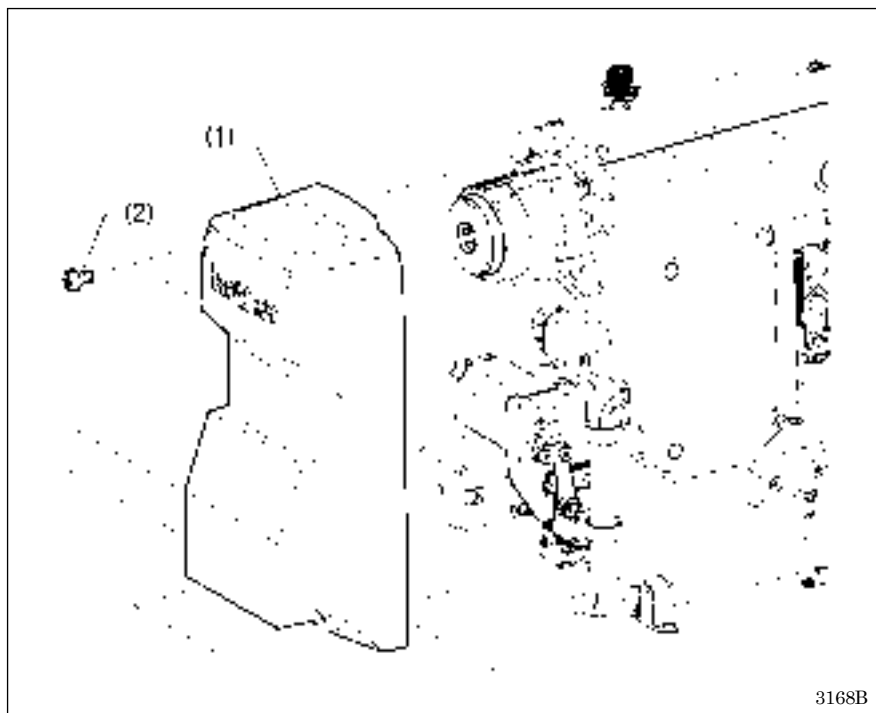

- (1) Rear cover
- (2) Screws [4 pcs]

NOTE:

Be careful not to clamp the cords when installing the rear cover (1).

3-12. Lubrication

⚠ CAUTION



Do not connect the power cord until lubrication has been completed, otherwise the machine may operate if the foot switch is depressed by mistake, which could result in injury.



Be sure to wear protective goggles and gloves when handling the lubricating oil and grease, so that they do not get into your eyes or onto your skin, otherwise inflammation can result. Furthermore, do not drink the oil or eat the grease under any circumstances, as they can cause vomiting and diarrhoea. Keep the oil out of the reach of children.

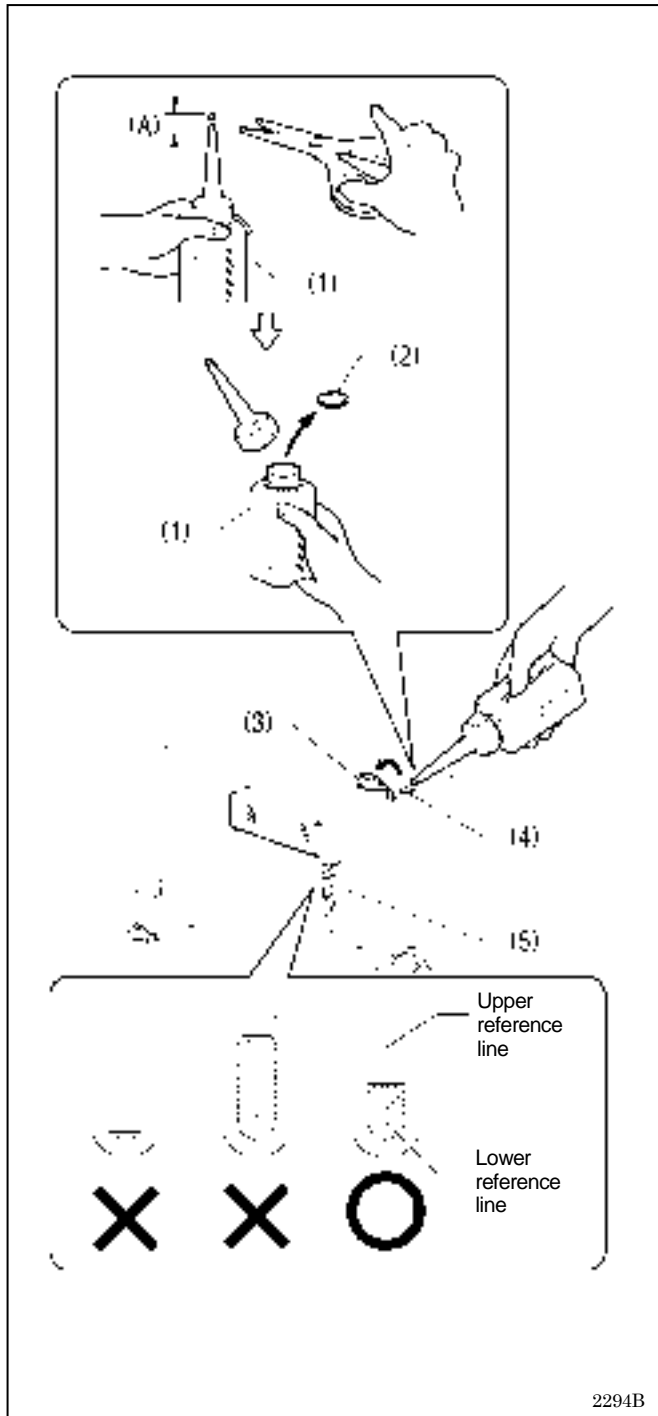

- The sewing machine should always be lubricated and the oil supply replenished before it is used for the first time, and also after long periods of non-use.
- Use only the lubricating oil <Nippon Oil Corporation Sewing Lube 10N; VG10> specified by Brother.
- * If this type of lubricating oil is difficult to obtain, the recommended oil to use is <Exxon Mobil EssoTex SM10; VG10>.

1. Hold the base of the nozzle of the accessory oil tank (1), and use scissors to cut about half-way along the straight section (A) of the nozzle.
2. Loosen and remove the nozzle, and then remove the seal (2).
3. Tighten the nozzle.
4. Open the oil feeding pocket cover (3).
5. Insert the nozzle of the oil tank (1) deeply into the oil feeding pocket (4), and then add lubricating oil.
6. Check that the oil level is between the upper reference line and the lower reference line in the oil gauge window (5).

NOTE:

- When the oil level drops below the lower reference line in the oil gauge window, be sure to add more oil. If the oil level drops below the lower reference line, problems with operation of the sewing machine such as seizing may occur.
- Do not add oil so that the oil level goes above the upper reference line, otherwise the oil may spill out when the machine head is tilted back

(Continued on next page.)

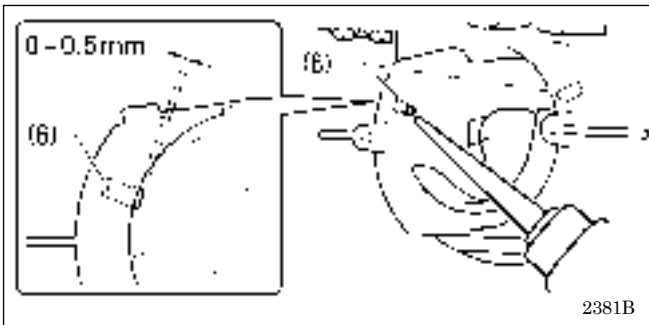

7. Pour oil in through the two holes of the shuttle race base assembly so that the felt (6) is lightly moistened.

NOTE:

- The two pieces of felt (6) should normally project by 0 to 0.5 mm from the hook race. Be careful not to push in the felt (6) when lubricating.
- If there is no more oil on the felt (6) of the shuttle race base assembly, problems with sewing may result.

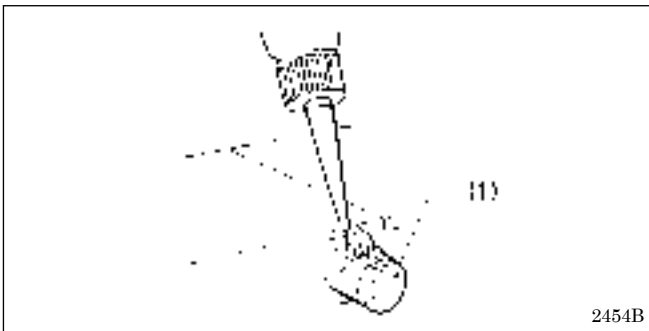

< When using the needle cooler (option) >

If using the needle cooler (option) (1), fill it with silicon oil.

3-13. Connecting the power cord

CAUTION



Be sure to connect the ground. If the ground connection is not secure, you run a high risk of receiving a serious electric shock, and problems with correct operation may also occur.

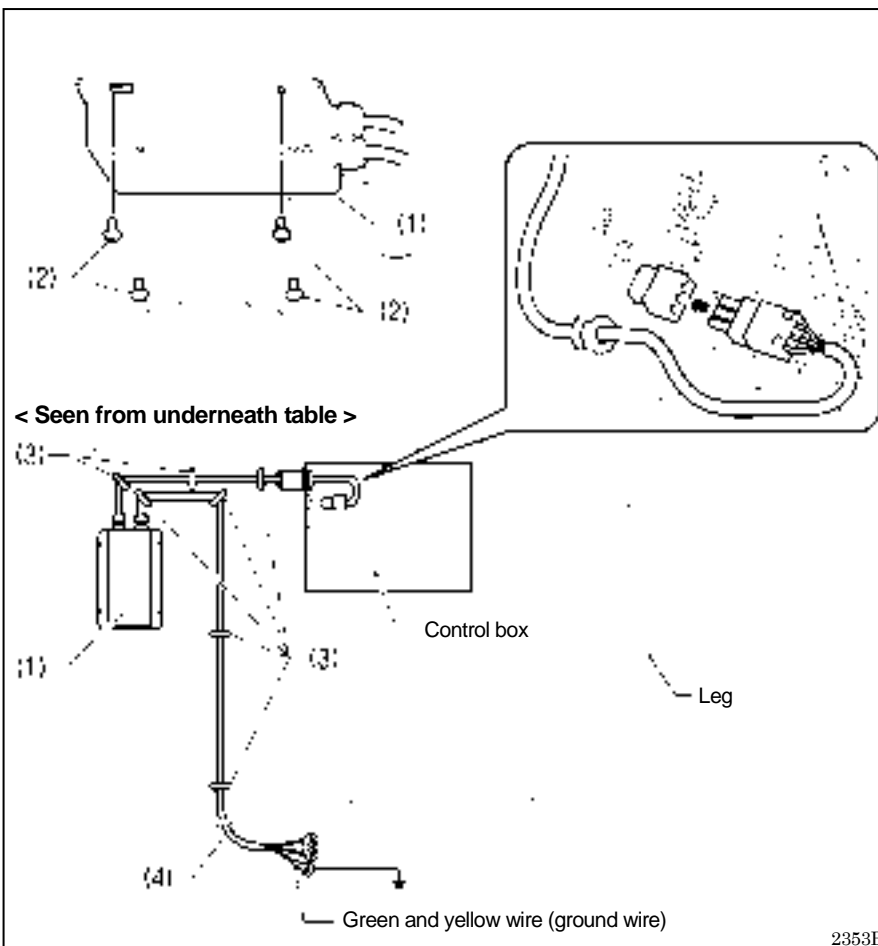

Connect cords that match the voltage specifications.

< EU specifications >

- (1) Filter box
- (2) Screws [4 pcs]
- (3) Staples [7 pcs]
- (4) Power cord

1. Attach an appropriate plug to the power cord (4). (The green and yellow wire is the ground wire.)
2. Insert the power plug into a properly-grounded electrical outlet.

NOTE:

- Take care when tapping in the staples (3) to make sure that they do not pierce the cords.
- Do not use extension cords, otherwise machine operation problems may result.

3. INSTALLATION

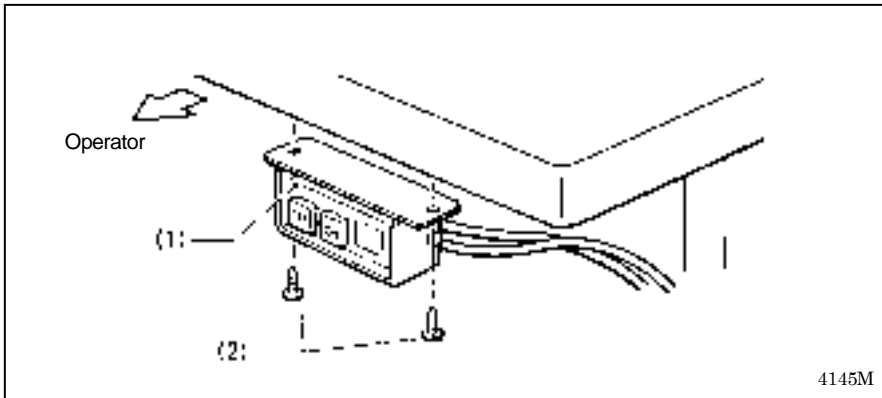

<200 V system >

- (1) Power switch
- (2) Screws [2 pcs]

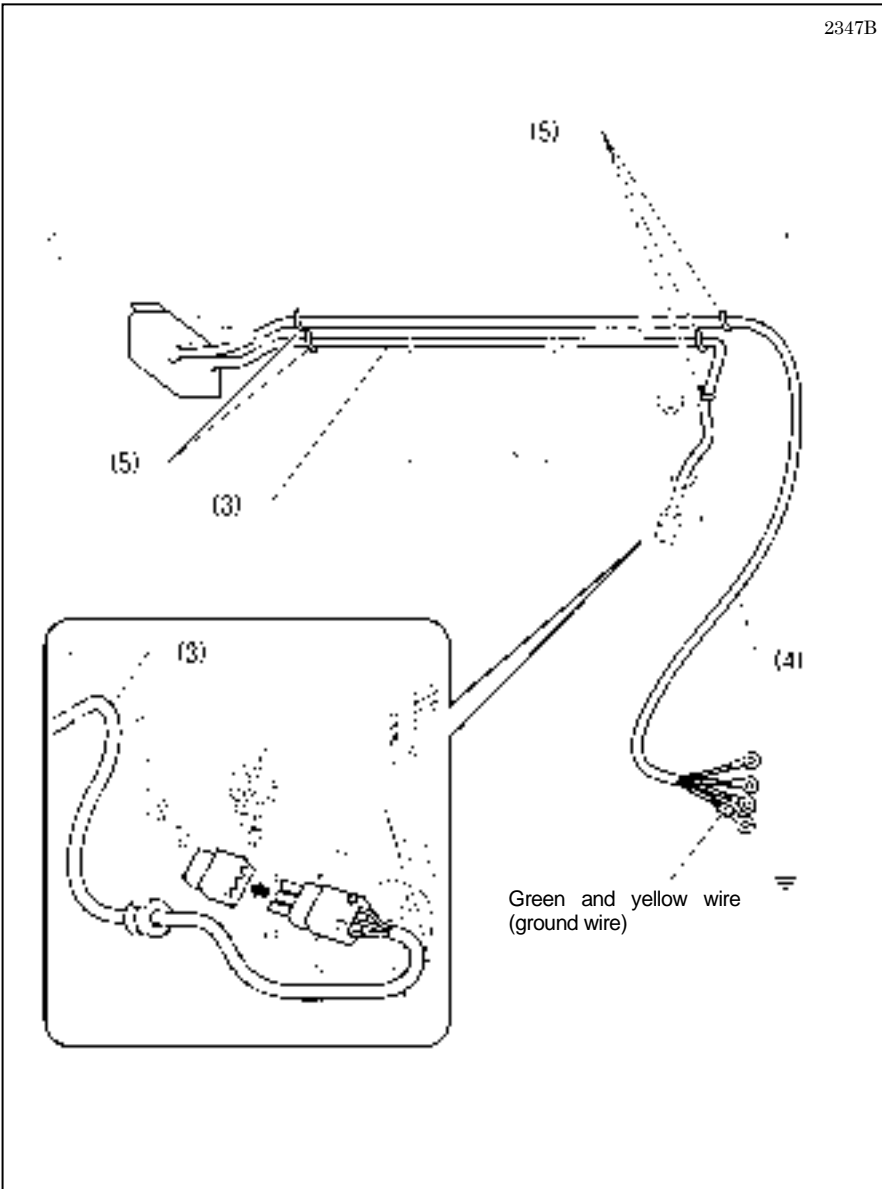

- (3) 3-pin power supply connector
- (4) Power cord
- (5) Staples [5 pcs]

1. Attach an appropriate plug to the power cord (4). (The green and yellow wire is the ground wire.)
2. Insert the power plug into a properly-grounded electrical outlet.

NOTE:

- Take care when tapping in the staples (5) to make sure that they do not pierce the cords.
 - Do not use extension cords, otherwise machine operation problems may result.
3. Use the six screws to tighten the cover of the control box. Check that none of the cords are being clamped by the cover at this time.

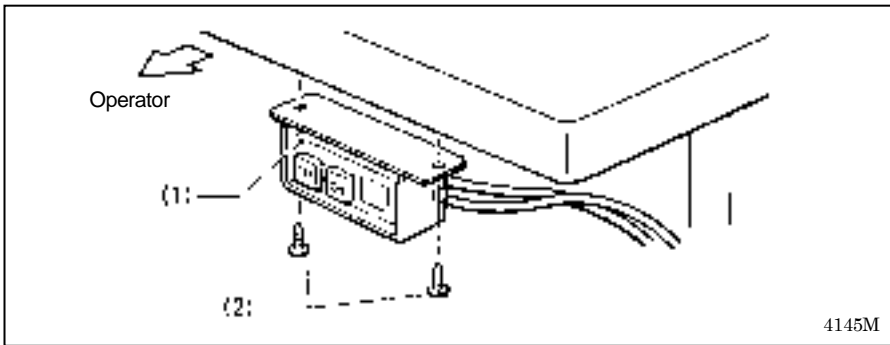

<100 V / 400 V system >

- (1) Power switch
- (2) Screws [2 pcs]

4145M

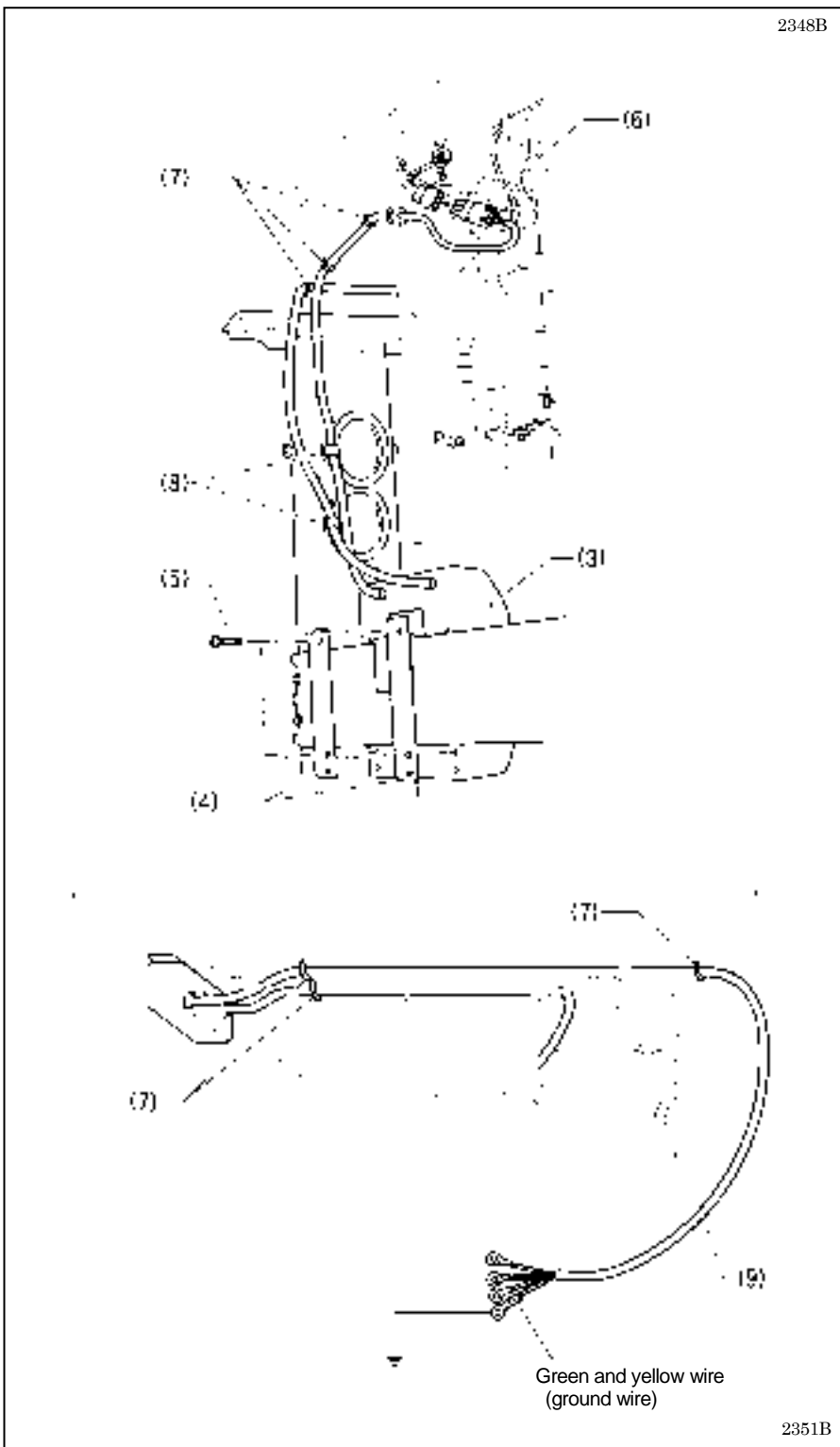

2348B

- (3) Transformer box
- (4) Transformer box plates [2 pcs]
- (5) Screw [with washer]
- (6) 3-pin power supply connector
- (7) Staples [6 pcs]
- (8) Cord clamps [2 pcs]
- (9) Power cord

1. Attach an appropriate plug to the power cord (9). (The green and yellow wire is the ground wire.)
2. Insert the power plug into a properly-grounded AC power supply.

* The inside of the control box uses single-phase power.

NOTE:

- If the ground connection is not secure, electric shocks, operating errors or damage to electronic components such as P.C. boards may occur.
- Take care when tapping in the staples (7) to make sure that they do not pierce the cords.
- Do not use extension cords, otherwise machine operation problems may result.

3. Use the six screws to tighten the cover of the control box. Check that none of the cords are being clamped by the cover at this time.

2351B

3-14. Checking the machine head switch

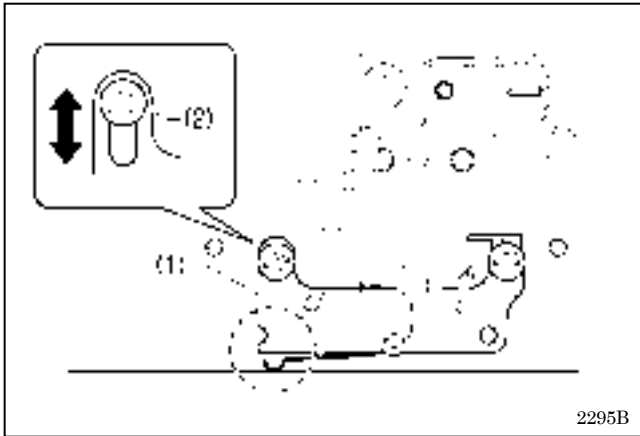

1. Turn on the power switch.
2. Check that no error numbers appear on the operation panel.

<If error [E050], [E051] or [E055] is displayed>

If the machine head switch (1) is not turned on, error [E050], [E051] or [E055] will occur.

Use the screw (2) to adjust the installation position of the machine head switch as shown in the illustration.

2295B

3-15. Starting up

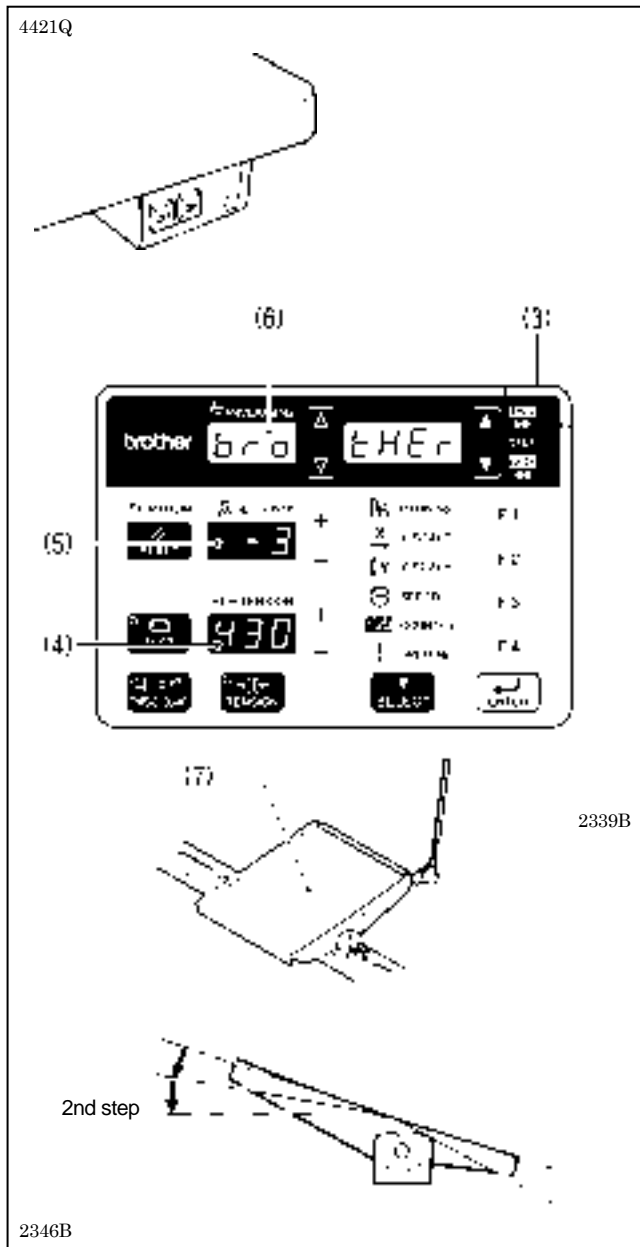

1. Turn on the power switch.
The POWER indicator (3) will illuminate, and the model name will appear in the tension value display (4) and the specifications will appear in the section No. display (5).

Specifications		Display
Medium-weight materials	[-03]	- 3
Heavy-weight materials	[-05]	- 5
Knitted materials	[-0K]	- K
Foundation garments	[-0F]	- F

After this, the program number will flash in the program No. display (6).

2. Depress the foot switch (7) to the 2nd step.
The feed mechanism will move to the home position and the work clamp / button clamp will rise.

2339B

2346B

4. PREPARATION BEFORE SEWING

4-1. Installing the needle

CAUTION

 Turn off the power switch before installing the needle, otherwise the machine may operate if the foot switch is depressed by mistake, which could result in injury.

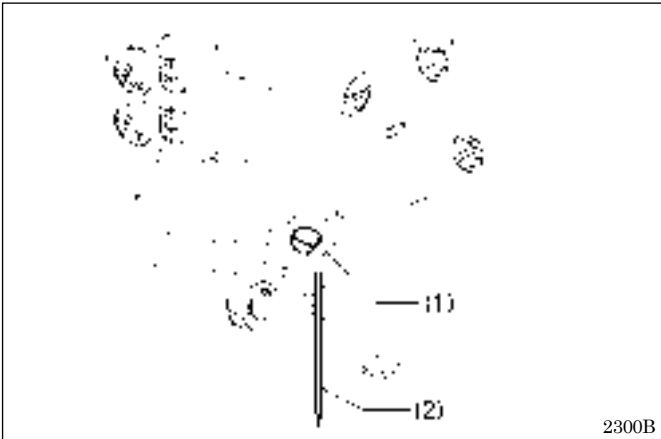

1. Loosen the set screw (1).
2. Insert the needle (2) in a straight line as far as it will go, making sure that the long groove on the needle is at the front, and then securely tighten the screw (1).

4-2. Threading the upper thread

Thread the upper thread correctly as shown in the illustration below.

* When using threading mode for threading, the tension discs (1) will open so that the thread can be threaded more easily. (Refer to following page.)

[When using the needle cooler (option)]

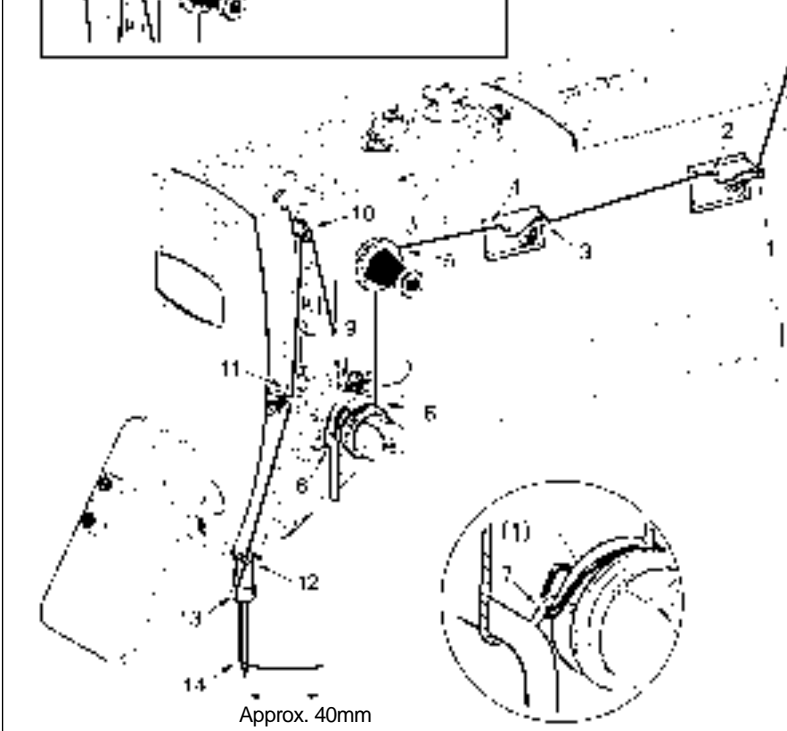

Approx. 40mm

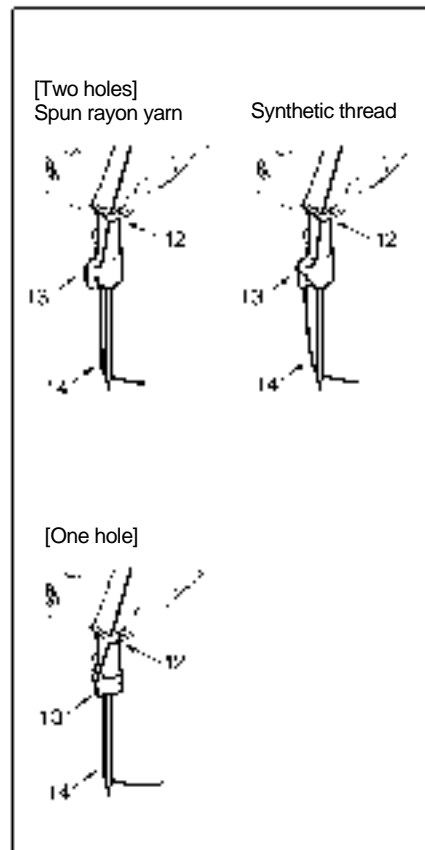



3169B

4. PREPARATION BEFORE SEWING

<Threading mode>

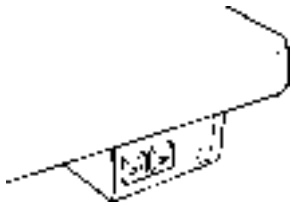
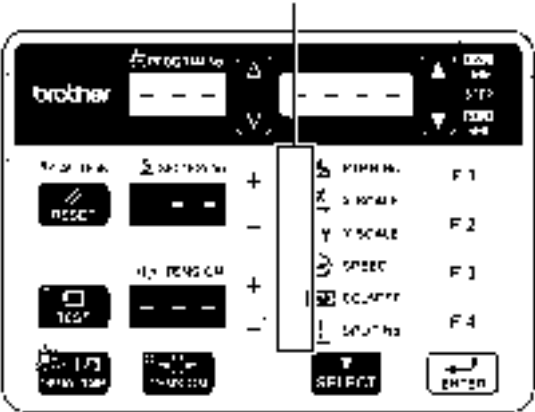
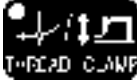
Threading mode is safe because the sewing machine will not start even when the foot switch is depressed.

1	<p>Turn on the power switch.</p>  <p style="text-align: right;">4421Q</p>
2	<p>Press the THREAD/CLAMP key.</p> <p>All indicators switch off</p>   <ul style="list-style-type: none"> The work clamp /button clamp will lower. <p style="text-align: right;">2340B 2389B</p>
3	<p>Threading the thread.</p>
4	<p>Ending threading mode</p> <p>Press the THREAD/CLAMP key.</p> <ul style="list-style-type: none"> The work clamp/button clamp will return to where it was before threading mode was started.  <p>THREAD/CLAMP indicator switches off</p> <p style="text-align: right;">2390B</p>

4-3. Winding the lower thread

CAUTION

 Do not touch any of the moving parts or press any objects against the machine while winding the lower thread, as this may result in personal injury or damage to the machine.

3170B

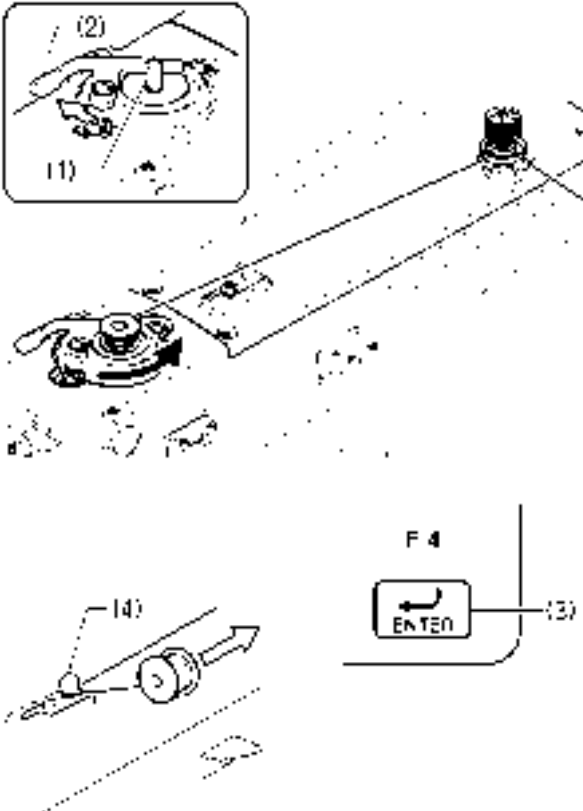

3171B

2341B

1. Place the bobbin onto the bobbin winder shaft (1).
2. Thread the thread as shown in the illustration, wind the thread around the bobbin several times, and then press the bobbin presser arm (2).
3. Turn on the power switch.
4. Depress the foot switch to the second step. The feed mechanism will move to the home position.
5. Check that the needle is not touching the work clamp/button clamp, and then while pressing the ENTER key (3), depress the foot switch to the second step.
6. Release the ENTER key (3) after the machine starts operating, and keep depressing the foot switch until the lower thread stops being wound onto the bobbin. (If you release the foot switch before winding is complete, and then depress it again while pressing the ENTER key (3), winding will start again.)
7. Once winding of the set amount of lower thread (80 - 90% of the bobbin capacity) is completed, the bobbin presser arm (2) will return automatically.
8. Remove the bobbin, hook the thread onto the knife (4), and then pull the bobbin in the direction of the arrow to cut the thread.

3172B

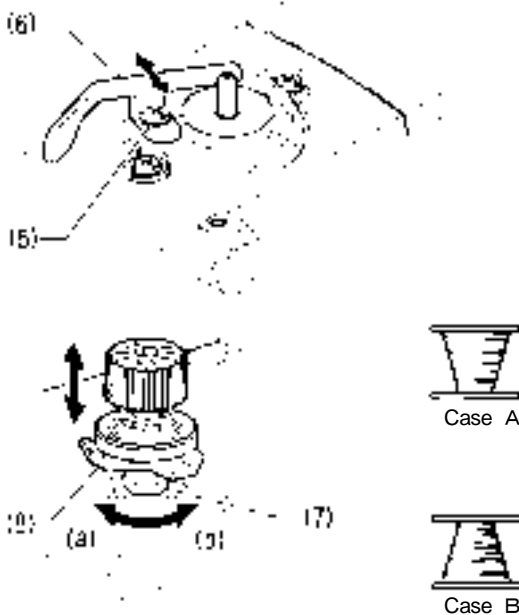

3173B

Adjusting the bobbin winding amount

Loosen the screw (5) and move the bobbin presser (6).

If the thread winds onto the bobbin unevenly

Loosen the nut (7) and move the bobbin winder tension assembly (8) up and down to adjust.

* For case A, turn the bobbin winder tension assembly (8) clockwise (a), and for case B, turn it counterclockwise (b).

4-4. Installing the bobbin case

⚠ CAUTION



Turn off the power switch before installing the bobbin case, otherwise the machine may operate if the foot switch is depressed by mistake, which could result in injury.

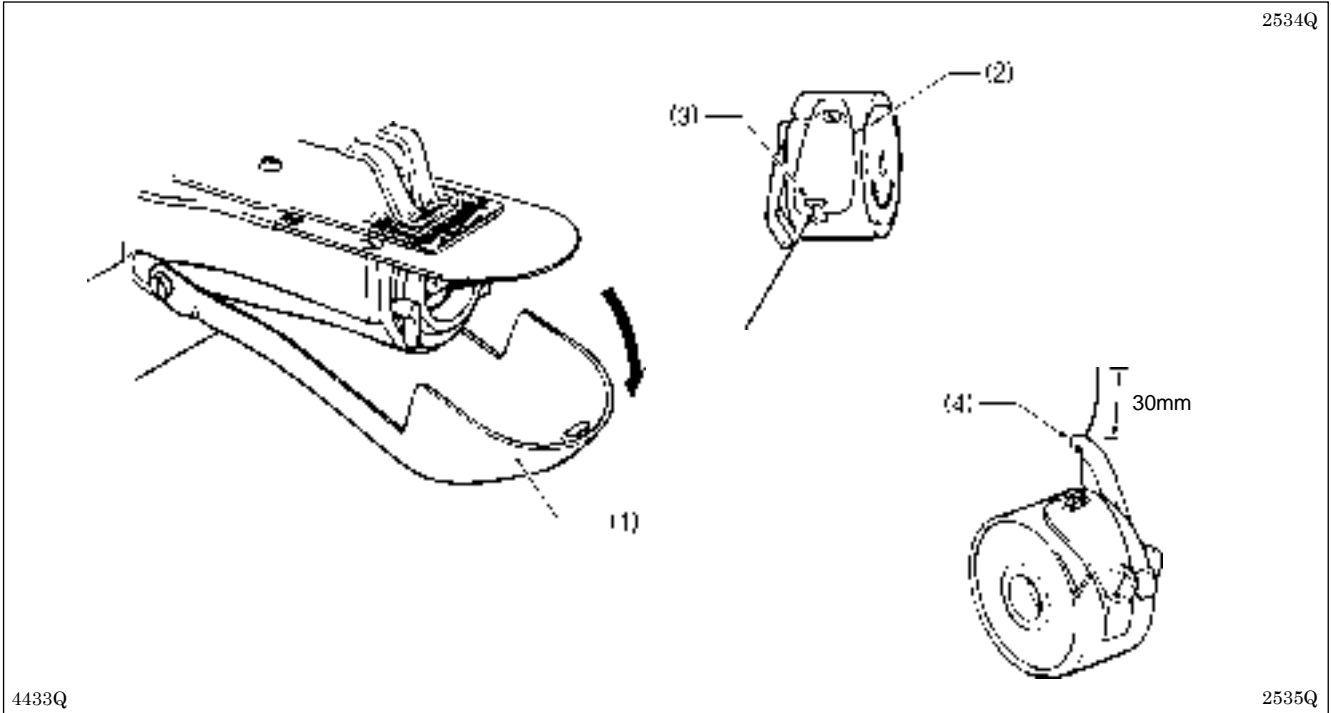

1. Pull the shuttle race cover (1) downward to open it.
2. While holding the bobbin so that the thread winds to the right, insert the bobbin into the bobbin case.
3. Pass the thread through the slot (2) and pull it out from the thread hole (3).
4. Check that the bobbin turns in the direction of the arrow when the thread is pulled.
5. Pass the thread through the lever thread hole (4), and then pull out approximately 30 mm of thread.
6. Hold the latch on the bobbin case and insert the bobbin case into the rotary hook.

4-5. Thread tension

4-5-1. Lower thread tension

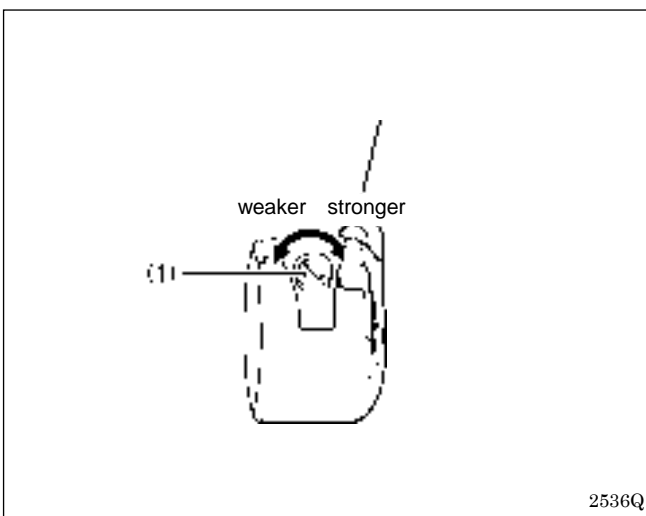

Adjust the thread tension to the weakest possible tension by turning the thread tension nut (1) until the bobbin case will not drop by its own weight while the thread end coming out of the bobbin case is held.

4-5-2. Upper thread tension

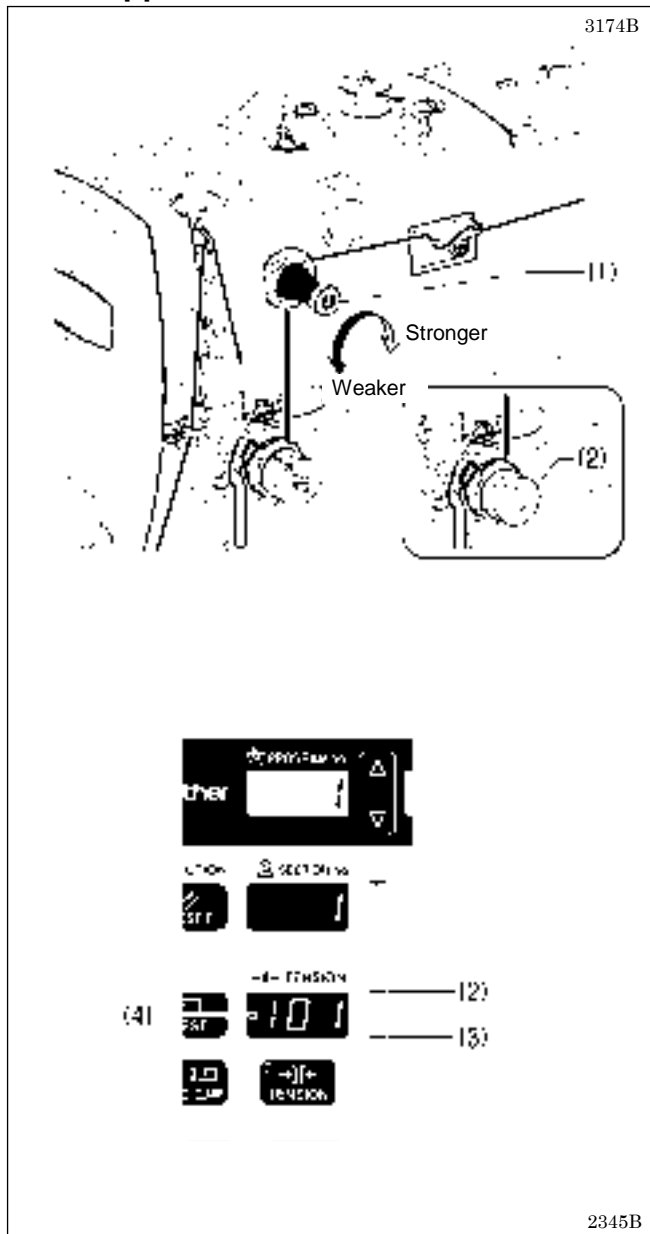

Use the digital tension or the tension nut (2) to adjust the tension as appropriate for the material being sewn. (Refer to "Setting the tension value".)

Furthermore, turn the tension nut (1) (sub-tension) to adjust the remaining length of upper thread to 35 - 40 mm, when the thread take-up lever is not used.

Setting the tension value <For KE-430FX and BE-438FX>

Press the \oplus key (2) or the \ominus key (3) to change the tension value (4).

* The tension value which has been set will be applied the next time sewing is carried out.

2382B
2383B

[Reference thread tension]

Use	KE-430FX·FS				BE-438FX
	Medium-weight materials (-03)	Knitted wear (-0K)	Foundation garments (-0F)	Heavy-weight materials (-05)	
Upper thread	#50 or equivalent	#60 or equivalent	#60 or equivalent	#30 or equivalent	#60 or equivalent
Lower thread	#50 or equivalent	#80 or equivalent	#60 or equivalent	#50 or equivalent	#60 or equivalent
Upper thread tension (N) [Tension value] *1	0.8 - 1.2 [80 - 120]*2			1.2 - 1.8 [70 - 130]*2	0.5 - 1.2 [50 - 150]*2
Lower thread tension (N)	0.2 - 0.3				0.2 - 0.3
Pre-tension (N)	0.05 - 0.3				0.1 - 0.4
Needle	DP x 5 #14	DP x 5 #9	DP x 5 KN#11	DPx17NY#19	DPx17NY#12

*1: For KE-430FX and BE-438FX.

*2: This is the tension value when the pretension is 0.05 N.

4. PREPARATION BEFORE SEWING

[Guide to maximum sewing speed for KE-430FX·FS]

Use	Max. sewing speed (sti/min)	
	Standard hook	Large hook
8 layers of denim	3,200	2,500
12 layers of denim	2,700	
Ordinary materials	2,700	2,500
For knitted materials and foundation garments	2,500	

NOTE:

The thread may break due to heat under some sewing conditions. If this happens, reduce the sewing speed, or use the needle cooler (option).

4-6. Thread nipper device <KE-430FX-03, -0K, -0F>

This is used to stop the thread from pulling out at the sewing start, and at times when skipped stitches might easily occur. The thread nipper device operates when memory switch no. 500 is set to "ON". However, some limitations apply. Refer to "6-2. List of memory switches" for details.

* The default setting for this memory switch is "OFF".

[Notes on use]

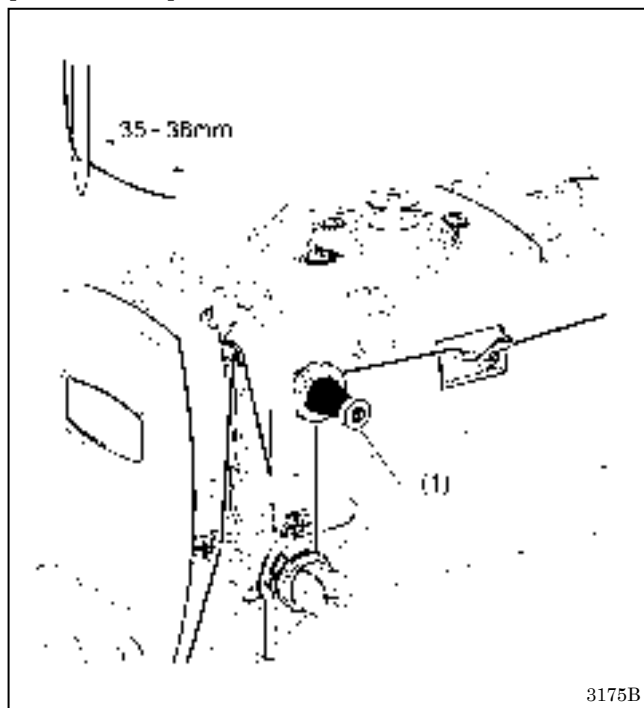

1. When using the thread nipper device, turn the tension nut (1) (sub-tension) to adjust the upper thread trailing length to 35 - 38 mm.

* Adjust the upper thread trailing length to less than 40 mm after replacing the upper thread also.

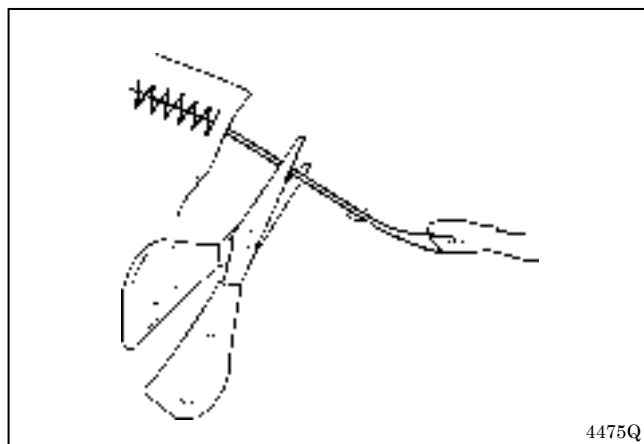

2. If the upper thread trailing length is 40 mm or more, or if the upper thread tension is weak and the upper thread does not form a good seam at the first stitch, the end of the thread that is being held by the thread nipper may become wound around the seam. Furthermore, if using thick thread that is #30 or higher or if the thread trailing length is too long, an error [E691] may occur. In any of these cases, use scissors to cut the thread without pulling it up too hard.

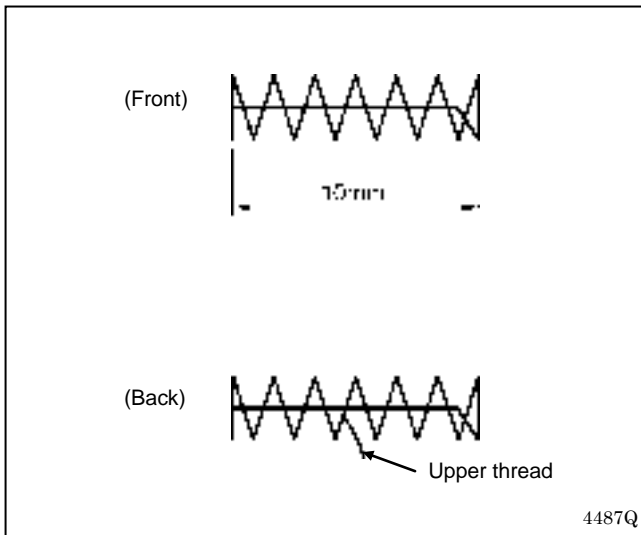

3. For sewing patterns with a short bar tack length (10 mm or less), the end of the thread that is being held by the thread nipper may poke out from the seam on the underside of the material. It is recommended that you change the thread nipper setting to "OFF" for patterns such as these.
4. If error [E690] or [E691] frequently occurs, remove the needle plate and remove any thread scraps from underneath the needle plate.

5. With the KE-430FX, the lower thread may poke out from the underside of the material on the 2nd stitch for some types of material and thread. If this happens, it is recommended that you use sewing patterns that are designed for use with the thread nipper device.
Refer to "2-2. List of Sewing Patterns (KE-430FX·FS)" for details of the sewing patterns.

<Program No. Reference Table>

Specifications	Standard pattern No.	Pattern No. for thread nipper device
For medium-weight materials (-03)	1	65
	4	66
	5	67
	8	68
	13	69
	15	70
	20	71
For heavy-weight materials (-05)	21	72
	2	78
	3	79
	6	80
	14	81
	16	82
	17	83
For knitted wear (-OK) For foundation garments (-0F)	18	84
	19	85
	7	73
	9	74
	22	75
	31	76
	32	77

4-7. Inserting the button (BE-438FX)

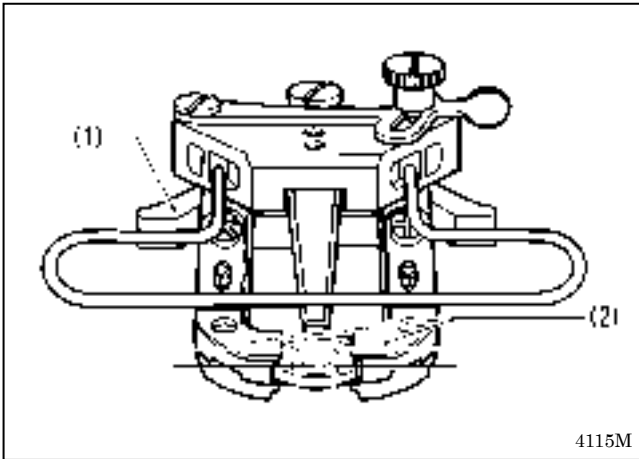

1. Press the button clamp plate cam (1) to open the button holder (2).
2. Insert the button, making sure that the button is facing the directing shown in the illustration, then release the button clamp plate cam (1).

4-8. Adjusting the button clamp (BE-438FX)

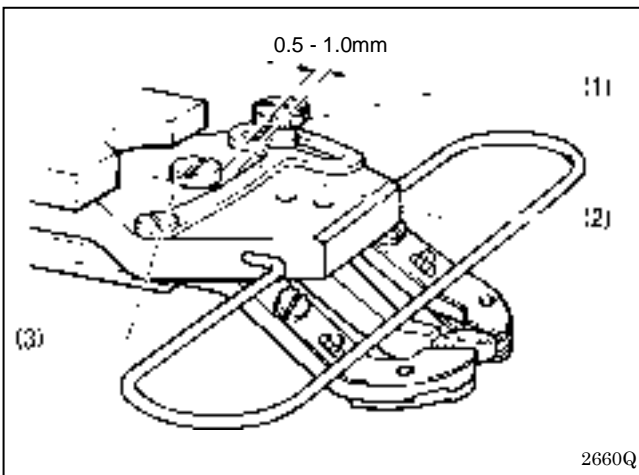

1. Insert the button in the button clamp, and then confirm that the button is securely held by the clamp and that the button can be turned by hand.
2. Loosen the shoulder screw (1), while the button is held by the clamp. Move the adjusting plate (2) so that the space between the adjusting plate (2) and screw (3) is approximately 0.5 - 1.0 mm, then tighten the shoulder screw (1).

4-9. Installing the accessory spring (BE-438FX)

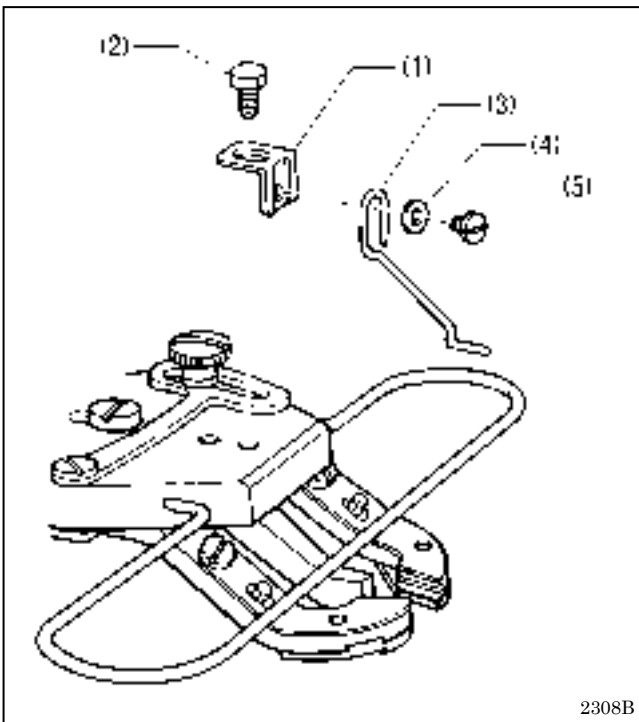

If you would like the button to be raised up more after it is sewn, install the accessory spring.

1. Install the spring support (1) with the bolt (2).
 2. Install the spring (3) with the washer (4) and the screw (5).
- * Adjust so that the spring (3) is in the middle of the button.

5. USING THE OPERATION PANEL (BASIC OPERATIONS)

5-1. Name and function of each operation panel item

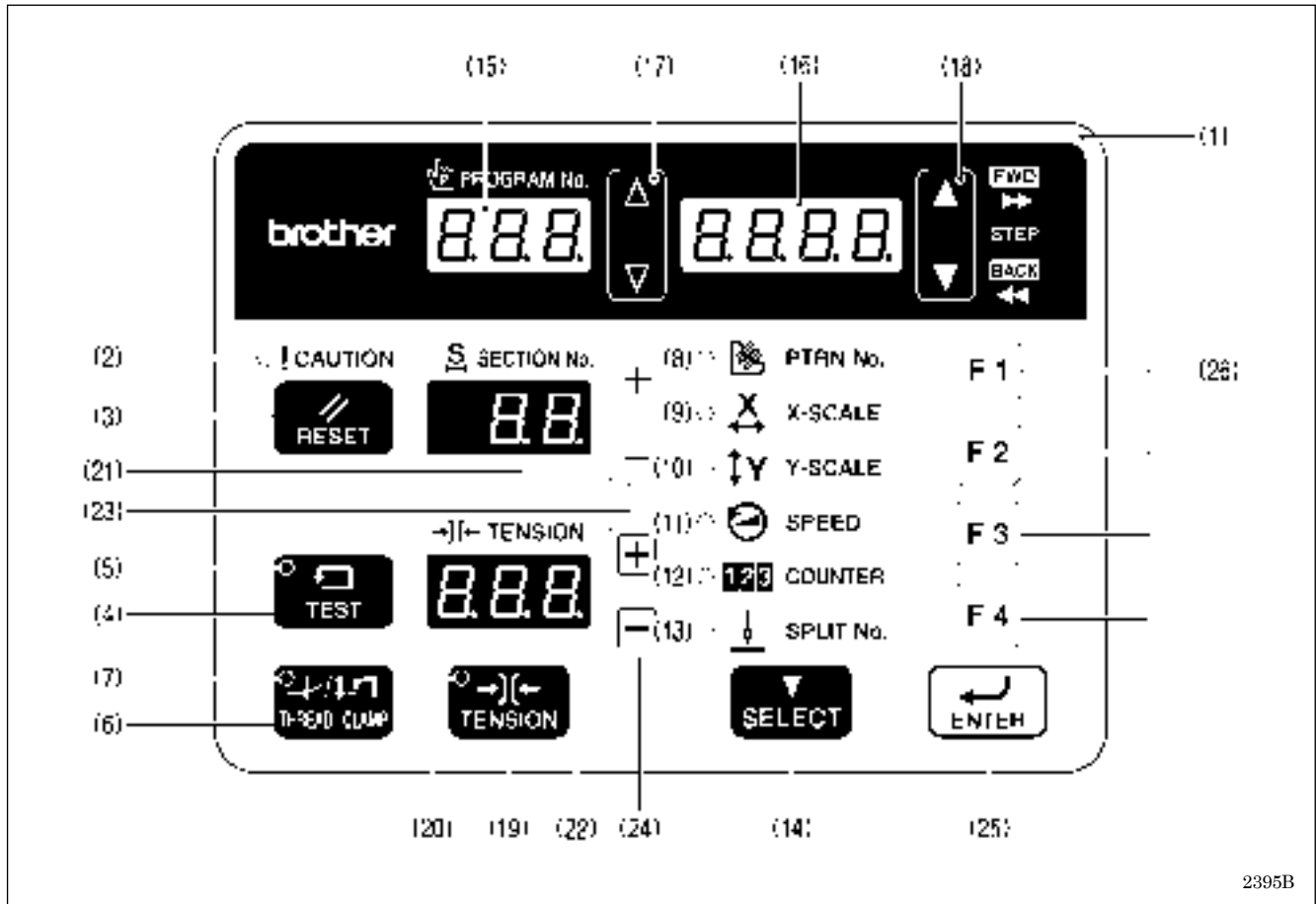

(1) Power indicator

Illuminates when the power is turned on.

(2) CAUTION indicator

Illuminates when an error occurs.

(3) RESET key

Used to reset errors.

(4) TEST key

Used to switch to test mode, or it can be used in combination with other keys to switch to other setting modes.

(5) TEST indicator

Illuminates when the TEST key (4) has been pressed.

(6) THREAD/CLAMP key

Used to switch to threading mode.

(7) THREAD/CLAMP indicator

This illuminates when the work clamp/button clamp is switched in threading mode or by using the SELECT key (14).

(8) PATTERN No. indicator

Illuminates when the SELECT key (14) is pressed to switch to the pattern number.

(9) X-SCALE indicator

Illuminates when the SELECT key (14) is pressed to switch to the X-scale setting.

(10) Y-SCALE indicator

Illuminates when the SELECT key (14) is pressed to switch to the Y-scale setting.

(11) SPEED indicator

Illuminates when the SELECT key (14) is pressed to switch to the sewing speed setting.

5. USING THE OPERATION PANEL (BASIC OPERATIONS)

(12) COUNTER indicator

Illuminates when the SELECT key (14) is pressed to switch to the lower thread or production counter setting.

(13) SPLIT No. indicator

Illuminates when the SELECT key (14) is pressed to show the split setting when split data (for specifying a pause while the program is running) exists.

(14) SELECT key

Used to switch the menu display (pattern No., X-scale and Y-scale, sewing speed, work clamp/button clamp lift amount, counter).

(15) PROGRAM No. display

This shows information such as program numbers.

(16) Menu display

Displays information such as menu setting values, memory switch settings and error codes.

(17) Setting keys ▽ ▲

Used to change the value which is displayed in the PROGRAM No. display (15).

(18) Setting keys ▼ ▲

Used to change the value which is displayed in the menu display (16).

(19) TENSION key

Used to switch to tension correction value display mode.

(20) TENSION indicator

Illuminates when in tension correction value display mode.

(21) SECTION No. display

Shows the section number when you select a pattern in which the upper thread tension changes while the pattern is being sewn.

(22) TENSION display <For KE-430FX and BE-438FX>

Shows the upper thread tension value.

(23) Setting keys [+ , -]

Used to change the value which is displayed in the SECTION No. display (21).

(24) Setting keys []

Used to change the value which is displayed in the TENSION display (22).

(25) ENTER key

Used to accept the values which are displayed in places such as the menu display (16).

(26) Function keys [F1, F2, F3, F4]

Used to directly select program numbers and cycle program numbers.

5-2. Program setting method

Patterns, X-scale, Y-scale, sewing speed, slow start pattern and upper thread tension can be recorded into programs.

When a program number is selected, the program which has been set for that number can then be sewn.

Program numbers 1 to 89 (1 to 64 for the 438FX) have patterns preprogrammed into the program numbers with the same numbers as the pattern numbers, and these pattern numbers cannot be changed. All items in program numbers 200 to 999 can be set as desired by the user.

1 Switch to program mode.



TEST indicator flashes, PTRN No. indicator illuminates

While pressing the TEST key, press the SELECT key.

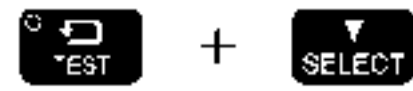

- The program number will be displayed in the PROGRAM No. display, and "Ptno" will be displayed in the menu display.
- If a pattern has been recorded in a program, the number for that pattern will be displayed in the TENSION display, and if no pattern has been recorded, "—" will be displayed.

2 Select the program number that you would like to change the parameters for.

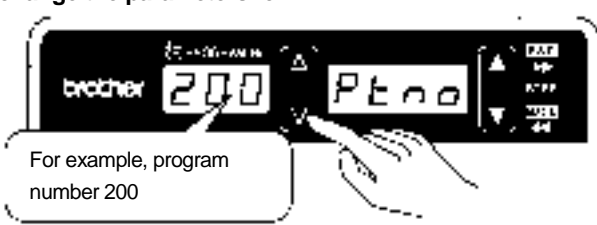

For example, program number 200

Press the Δ or ∇ key to set the program number that you would like to record.

- Program numbers 1 to 89 (1 to 64 for the 438FX) have the following restrictions. If you would like to create your own programs using sewing patterns, use program numbers 200 to 999.

Program No.	1 to 89 (430FX·FS), 1 to 64 (438FX)	200 to 999
Pattern selection operation	Not possible	Can be recorded as desired
Patterns that can be recorded	Patterns with same number as program number already recorded	All patterns recorded in the sewing machine

3 (If program number 200 to 999 is selected) Record a pattern.

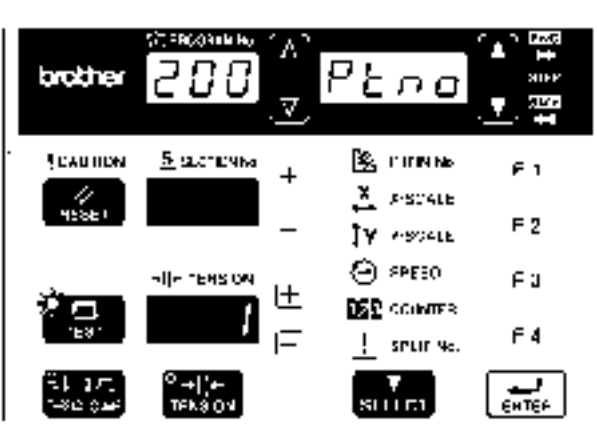

Press the \oplus or \ominus key to change the pattern number, and then press the ENTER key to apply the change.









- The setting ranges for other items will vary in accordance with the pattern which is recorded, so record the pattern first.
- If "—" is recorded as the pattern number, that particular program will no longer have anything recorded.
- If the display is flashing, it means that no pattern number has been entered and applied. If you press the SELECT key or the TEST key, the changes to the program contents will be canceled.

KE-430FX/KE-430FS, BE-438FX

36

5. USING THE OPERATION PANEL (BASIC OPERATIONS)

<p>4</p>	<p>Select the item to be changed.</p>	<p>Press the SELECT key.</p> <div style="text-align: right;">  <p>2401B</p> </div> <ul style="list-style-type: none"> The selected parameter changes in the order shown in the illustration below each time the SELECT key is pressed. <p style="text-align: center;">Pattern → X-scale → Y-scale → Sewing speed → Slow start pattern → Upper thread tension</p>
<p>5</p>	<p>Change the setting for the parameter. (Refer to “List of parameters” on the next page for details on parameter changes.)</p>  <p style="text-align: right;">2402B</p>	<p>Press the  or  key to change the parameter setting.</p> <p style="text-align: right;">2382B 2383B</p> <ul style="list-style-type: none"> The flashing display means that the parameter setting has not yet been applied. You can make the initial setting appear in the display by pressing the RESET key.
<p>6</p>	<p>Apply the changed parameter setting.</p>  <p style="text-align: right;">2403B</p>	<p>Press the ENTER key.</p> <ul style="list-style-type: none"> The display will change from flashing to illuminated, and this means that the setting has been applied. If you press the SELECT key or the TEST key without pressing the ENTER key, you can cancel the parameter changes.
<p>7</p>	<p>Repeat steps 4 to 6 above to record the settings for each parameter.</p>	
<p>8</p>	<p>If you would like to continue setting another program, repeat steps 2 to 7 above.</p>	
<p>9</p>	<p>Exit program mode.</p>  <p style="text-align: right;">2404B</p>	<p>Press the TEST key.</p> <ul style="list-style-type: none"> The display will return to the normal display. <p style="text-align: center;">TEST indicator switches off</p>

<List of parameters>

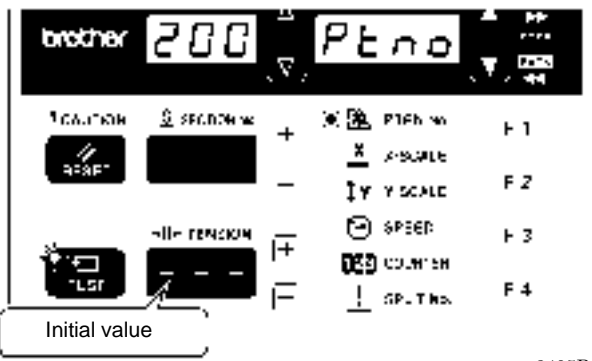
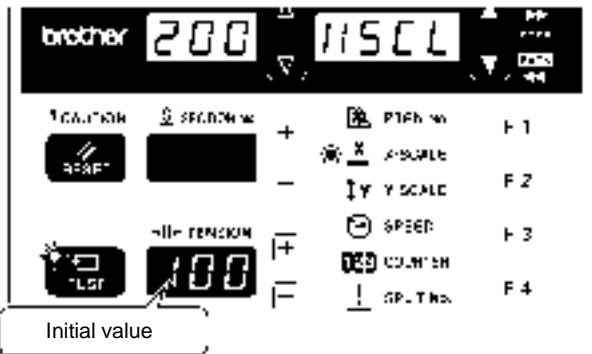
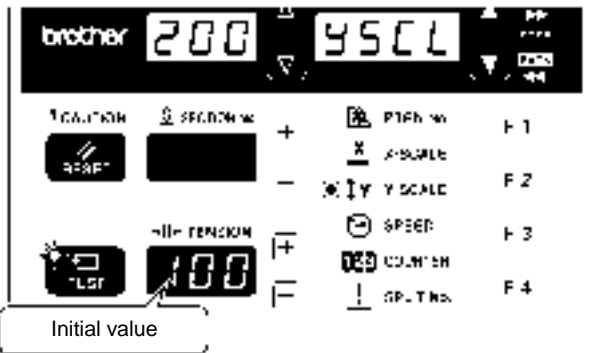
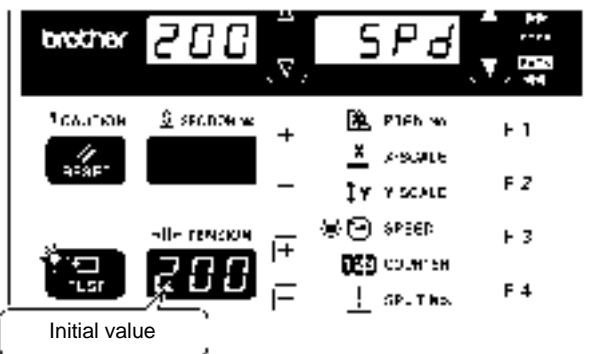



Parameter	Setting range and initial value	Display
<p>Pattern</p>	<p>[For program numbers 1 to 89 (1 to 64 for the 438FX)] The setting cannot be changed.</p> <hr/> <p>[For program numbers 200 to 999] "---", 1 to 89 (1 to 64 for the 438FX), additional recorded pattern numbers.</p>	 <p style="text-align: right;">2405B</p>
<p>X-scale</p>	<p>20% - 200% (Limited by available sewing area.)</p> <p>(Initial value is 100%.)</p> <p>* The setting can be displayed in "mm" units by setting memory switch No. 402 to "ON".</p>	 <p style="text-align: right;">2406B</p>
<p>Y-scale</p>	<p>20% - 200% (Limited by available sewing area.)</p> <p>(Initial value is 100%.)</p> <p>* The setting can be displayed in "mm" units by setting memory switch No. 402 to "ON".</p>	 <p style="text-align: right;">2407B</p>
<p>Sewing speed</p>	<p>430FX·FS: 200 sti/min to 3200 sti/min 438FX: 200 sti/min to 2700 sti/min Setting units are 100 sti/min.</p> <p>(Initial value is 2000 sti/min.)</p> <p>* The setting is displayed in units of 10 sti/min. For a setting of 2000 sti/min, the display will be "200".</p>	 <p style="text-align: right;">2408B</p>

5. USING THE OPERATION PANEL (BASIC OPERATIONS)

Parameter	Setting range and initial value	Display																																																		
Slow start pattern	Lo1-Lo9 (Initial values: 430FX·FS: Lo8, 438FX: Lo7) The starting-up speed at the sewing start can be adjusted. * The smaller the number, the slower the start. * This is used to stop the thread from pulling out at the sewing start, and at times when skipped stitches might easily occur.																																																			
	430FX·FS: Medium-weight materials (-03), knitted wear (-0K), foundation garments (-0F)	<table border="1"> <thead> <tr> <th></th> <th>Lo1</th> <th>Lo2</th> <th>Lo3</th> <th>Lo4</th> <th>Lo5</th> <th>Lo6</th> <th>Lo7</th> <th>Lo8</th> <th>Lo9</th> </tr> </thead> <tbody> <tr> <td>Sewing speed for 1st stitch</td> <td>200</td> <td>200</td> <td>300</td> <td>400</td> <td>400</td> <td>400</td> <td>400</td> <td>800</td> <td>1500</td> </tr> <tr> <td>Sewing speed for 2nd stitch</td> <td>200</td> <td>300</td> <td>400</td> <td>400</td> <td>500</td> <td>600</td> <td>800</td> <td>1200</td> <td>3000</td> </tr> <tr> <td>Sewing speed for 3rd stitch</td> <td>300</td> <td>400</td> <td>500</td> <td>600</td> <td>800</td> <td>800</td> <td>1200</td> <td>2500</td> <td>3200</td> </tr> <tr> <td>Sewing speed for 4th stitch</td> <td>500</td> <td>600</td> <td>700</td> <td>900</td> <td>1200</td> <td>1200</td> <td>2500</td> <td>3200</td> <td>3200</td> </tr> </tbody> </table>		Lo1	Lo2	Lo3	Lo4	Lo5	Lo6	Lo7	Lo8	Lo9	Sewing speed for 1st stitch	200	200	300	400	400	400	400	800	1500	Sewing speed for 2nd stitch	200	300	400	400	500	600	800	1200	3000	Sewing speed for 3rd stitch	300	400	500	600	800	800	1200	2500	3200	Sewing speed for 4th stitch	500	600	700	900	1200	1200	2500	3200	3200
		Lo1	Lo2	Lo3	Lo4	Lo5	Lo6	Lo7	Lo8	Lo9																																										
	Sewing speed for 1st stitch	200	200	300	400	400	400	400	800	1500																																										
	Sewing speed for 2nd stitch	200	300	400	400	500	600	800	1200	3000																																										
Sewing speed for 3rd stitch	300	400	500	600	800	800	1200	2500	3200																																											
Sewing speed for 4th stitch	500	600	700	900	1200	1200	2500	3200	3200																																											
430FX·FS: Heavy-weight materials (-05)	<table border="1"> <thead> <tr> <th></th> <th>Lo1</th> <th>Lo2</th> <th>Lo3</th> <th>Lo4</th> <th>Lo5</th> <th>Lo6</th> <th>Lo7</th> <th>Lo8</th> <th>Lo9</th> </tr> </thead> <tbody> <tr> <td>Sewing speed for 1st stitch</td> <td>200</td> <td>200</td> <td>300</td> <td>400</td> <td>400</td> <td>400</td> <td>800</td> <td>1500</td> <td>1500</td> </tr> <tr> <td>Sewing speed for 2nd stitch</td> <td>200</td> <td>300</td> <td>400</td> <td>400</td> <td>600</td> <td>800</td> <td>1200</td> <td>2000</td> <td>3000</td> </tr> <tr> <td>Sewing speed for 3rd stitch</td> <td>300</td> <td>400</td> <td>500</td> <td>600</td> <td>800</td> <td>1200</td> <td>2500</td> <td>2500</td> <td>3200</td> </tr> <tr> <td>Sewing speed for 4th stitch</td> <td>500</td> <td>600</td> <td>700</td> <td>900</td> <td>1200</td> <td>2500</td> <td>3200</td> <td>3200</td> <td>3200</td> </tr> </tbody> </table>		Lo1	Lo2	Lo3	Lo4	Lo5	Lo6	Lo7	Lo8	Lo9	Sewing speed for 1st stitch	200	200	300	400	400	400	800	1500	1500	Sewing speed for 2nd stitch	200	300	400	400	600	800	1200	2000	3000	Sewing speed for 3rd stitch	300	400	500	600	800	1200	2500	2500	3200	Sewing speed for 4th stitch	500	600	700	900	1200	2500	3200	3200	3200	
	Lo1	Lo2	Lo3	Lo4	Lo5	Lo6	Lo7	Lo8	Lo9																																											
Sewing speed for 1st stitch	200	200	300	400	400	400	800	1500	1500																																											
Sewing speed for 2nd stitch	200	300	400	400	600	800	1200	2000	3000																																											
Sewing speed for 3rd stitch	300	400	500	600	800	1200	2500	2500	3200																																											
Sewing speed for 4th stitch	500	600	700	900	1200	2500	3200	3200	3200																																											
438FX	<table border="1"> <thead> <tr> <th></th> <th>Lo1</th> <th>Lo2</th> <th>Lo3</th> <th>Lo4</th> <th>Lo5</th> <th>Lo6</th> <th>Lo7</th> <th>Lo8</th> <th>Lo9</th> </tr> </thead> <tbody> <tr> <td>Sewing speed for 1st stitch</td> <td>200</td> <td>200</td> <td>300</td> <td>300</td> <td>300</td> <td>400</td> <td>400</td> <td>400</td> <td>400</td> </tr> <tr> <td>Sewing speed for 2nd stitch</td> <td>200</td> <td>200</td> <td>300</td> <td>300</td> <td>400</td> <td>400</td> <td>400</td> <td>600</td> <td>900</td> </tr> <tr> <td>Sewing speed for 3rd stitch</td> <td>300</td> <td>300</td> <td>300</td> <td>400</td> <td>400</td> <td>400</td> <td>600</td> <td>900</td> <td>1500</td> </tr> <tr> <td>Sewing speed for 4th stitch</td> <td>300</td> <td>400</td> <td>400</td> <td>400</td> <td>400</td> <td>400</td> <td>900</td> <td>2000</td> <td>2000</td> </tr> </tbody> </table>		Lo1	Lo2	Lo3	Lo4	Lo5	Lo6	Lo7	Lo8	Lo9	Sewing speed for 1st stitch	200	200	300	300	300	400	400	400	400	Sewing speed for 2nd stitch	200	200	300	300	400	400	400	600	900	Sewing speed for 3rd stitch	300	300	300	400	400	400	600	900	1500	Sewing speed for 4th stitch	300	400	400	400	400	400	900	2000	2000	
	Lo1	Lo2	Lo3	Lo4	Lo5	Lo6	Lo7	Lo8	Lo9																																											
Sewing speed for 1st stitch	200	200	300	300	300	400	400	400	400																																											
Sewing speed for 2nd stitch	200	200	300	300	400	400	400	600	900																																											
Sewing speed for 3rd stitch	300	300	300	400	400	400	600	900	1500																																											
Sewing speed for 4th stitch	300	400	400	400	400	400	900	2000	2000																																											
	(sti/min) (sti/min) (sti/min)																																																			
Upper thread tension <For KE-430FX and BE-438FX>	0 - 300 (Initial setting is "75".) * The later the value, the stronger the upper thread tension.																																																			

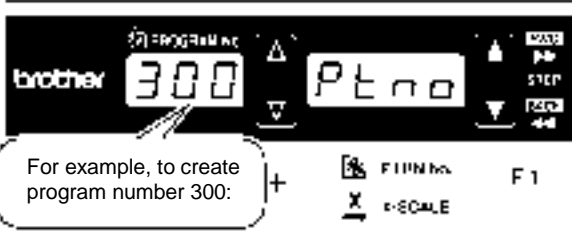

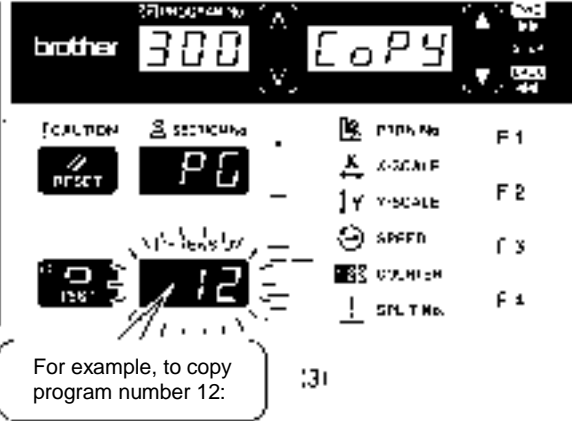





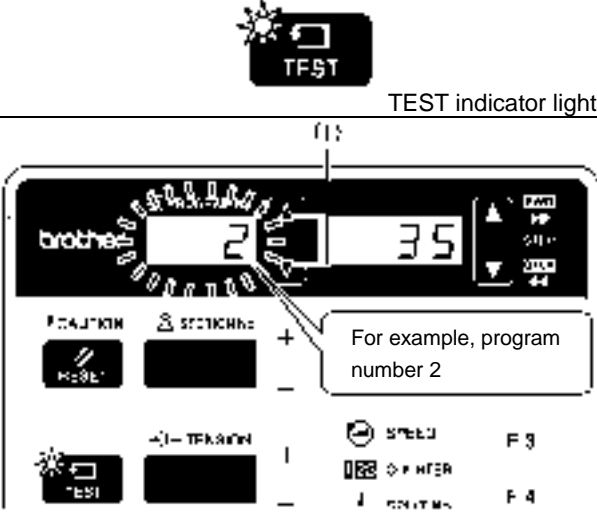

5-3. Copying programs

To create a program with parameters that are almost exactly the same as those of another program, you can copy the original program and change just the parts which need to be changed.

- | | | |
|-----------------|---|--|
| <p>1</p> | <p>Select the program number to be used for creating the new program.</p>  <p>2410B</p> | <p>Carry out steps 1 and 2 in “5-2. Program setting method” to select the program number to be used for creating the new program.</p> <ul style="list-style-type: none"> • Select a program number from 200 to 999. |
| <p>2</p> | <p>Switch to program copy mode.</p>  <p>2411B</p> | <p>While pressing the F1 key (1), press the F4 key (2).</p> <ul style="list-style-type: none"> • “CoPy” will be displayed in the menu display, “PG” will be displayed in the SECTION No. display, and the number of the program containing the original data will be displayed in the TENSION display. • The displays will not appear in this way unless a program number from 200 to 999 has been selected as the new program number. |
| <p>3</p> | <p>Select the program containing the original data.</p>  <p>2412B</p> | <p>Press the \oplus or \ominus key (3) to change the number of the program containing the original data.</p> <ul style="list-style-type: none"> • The value in the TENSION display will flash. • If you press the RESET key, you can cancel the copy operation and return to program mode. <p>2382B 2383B</p> |
| <p>4</p> | <p>Copy the program.</p>  <p>2413B</p> | <p>Press the ENTER key.</p>  <ul style="list-style-type: none"> • All parameters in the program will be copied, and the sewing machine will then return to the status in step 3 of “5-2. Program setting method”. <p>2414B</p> |
| <p>5</p> | <p>Change the necessary parameters.</p> | <p>Carry out the steps from step 4 onward in “5-2. Program setting method” to change the necessary parameters.</p> |







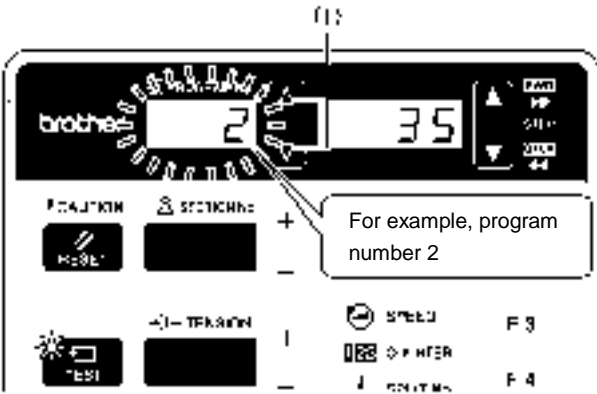

5-4. Checking the sewing pattern (KE-430FX·FS)

Use test feed mode to check the needle movement with only the work clamp operating.
Check that the needle hole does not come out from the frame of the work clamp.

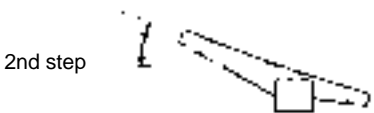
<p>1</p>	 <p>TEST indicator lights</p> <p>Program No. flashes → illuminates</p>	<p>1. Press the TEST key.</p> <ul style="list-style-type: none"> The number of stitches remaining until the final stitch will be displayed in the menu display. <p>2. Press the Δ or ∇ key (1) to set the program number that you would like to check.</p> <p>If the PROGRAM No. display is flashing, depress the foot switch to the 2nd step.</p> <ul style="list-style-type: none"> The feed mechanism will move to the home position and the program number will change from flashing to illuminated.  <p>2416B</p>
<p>2</p>	<p>Start continuous test feed mode.</p>  <p>4441Q</p> <div style="border: 1px solid black; padding: 5px;"> <p>[Test interrupt mode]</p>  <p>2nd step</p>  <p>TEST indicator flashes</p> <p>[Paused sewing standby mode]</p>  <p>2nd step</p>  <p>TEST indicator switches off</p>  </div>	<p>Depress the foot switch to the 2nd step and then release it.</p> <ul style="list-style-type: none"> The work clamp will start moving continuously one stitch at a time. (The stitch number display will be decremented by one stitch at a time.) The TEST indicator will flash. <p>[Fast-forward test mode]</p> <p>If you depress the foot switch to the 1st step while the work clamp is moving, the feeding speed will become faster while the foot switch is being depressed.</p> <p>If you would like the work clamp to stop moving, press the TEST key.</p> <ul style="list-style-type: none"> When the foot switch is depressed to the 2nd step, the work clamp will start moving again. <p>If you would like sewing to resume from the point where it was paused, press the TEST key while test feeding is paused to switch off the TEST indicator.</p> <ul style="list-style-type: none"> When you depress the foot switch to the 2nd step, sewing will start. <p>2404B 2416B 4441Q</p> <ul style="list-style-type: none"> If you press the \blacktriangle key (2) while in this mode, the work clamp will move forward by one stitch, and if you press the \blacktriangledown key (3), the work clamp will move back by one stitch. (It will move quicker if you keep the key pressed down.) If you press the RESET key, the work clamp will return to the sewing start position. <p>2417B</p>
<p>3</p>	<p>Once the test feed reaches the final stitch, the work clamp stops moving.</p>  <p>TEST indicator switches off</p>	<p>Press the TEST key.</p> <p>2404B</p>
<p>4</p>	<p>1st step</p> 	<p>Depress the foot switch to the 1st step. The work clamp will rise and the preparation for sewing will be completed.</p> <p>4441Q</p>

5-5. Checking the sewing pattern (BE-438FX)

Use test feed mode to check the needle movement with only the button clamp operating.

<p>1</p>	 <p>TEST indicator lights</p>  <p>Program No. flashes → illuminates</p>	<p>Press the TEST key.</p> <ul style="list-style-type: none"> The number of stitches remaining until the final stitch will be displayed in the menu display. <p>2416B</p> <p>2. Press the ▲ or ▼ key (1) to set the program number that you would like to check.</p> <p>If the PROGRAM No. display is flashing, depress the foot switch to the 2nd step.</p> <ul style="list-style-type: none"> The feed mechanism will move to the home position and the program number will change from flashing to illuminated.  <p>2415B 4441Q</p>
<p>2</p>	<p>Set the button. (Refer to “4-7. Inserting the button”.)</p>	
<p>3</p>	<p>Start single-stitch test feed mode.</p>  <p>4441Q</p> <p>After this, the button clamp will move forward by one stitch each time you depress the foot switch to the 1st step. Turn the pulley by hand each time the button clamp moves by one stitch, and check whether the needle drops into the hole of the button without touching the button. (If you turn the machine pulley one full rotation in the direction of sewing machine operation at this time, the button clamp will move forward by one stitch when the needle bar is near the needle up position.)</p> <p>In addition, when the foot switch is depressed to the 2nd step, the button clamp will move continuously by 1 stitch at a time as long as the foot switch is kept depressed.</p>	<p>Depress the foot switch to the 2nd step and then release it.</p> <ul style="list-style-type: none"> The button clamp will move by one stitch only. The TEST indicator will flash. <p>[Paused sewing standby mode]</p>  <p>TEST indicator switches off</p>  <p>2404B 4441Q</p>  <ul style="list-style-type: none"> If you press the ▲ key (1) while in this mode, the button clamp will move forward by one stitch, and if you press the ▼ key (2), the button clamp will move back by one stitch. (It will move quicker if you keep the key pressed down.) If you would like to start single-stitch test feed once more, press the TEST key so that the TEST indicator flashes. If you press the RESET key, the button clamp will return to the sewing start position.  <p>TEST indicator flashes</p> <p>2417B 2416B</p>
<p>4</p>	<p>End test feeding.</p>  <p>TEST indicator switches off</p> <p>2404B</p>	<p>5</p> <p>Depress the foot switch to the 1st step. The button clamp will be raised and preparation for sewing will be complete.</p>  <p>4441Q</p>

5-6. Correcting the upper thread tension <For KE-430FX and BE-438FX>

The upper thread tension value is always displayed during sewing standby mode, and it can be changed at any time.

<A. Basic method of use>

The changes made at this time will be reflected in each program, so this is a useful way of changing programs while checking actual sewing.

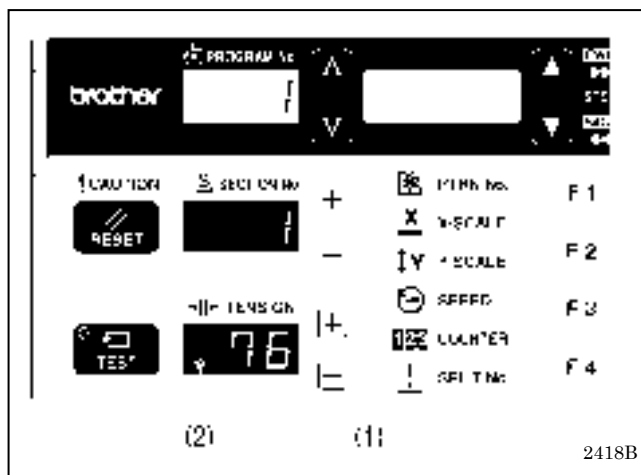

1. Press the \oplus or \ominus key (1) to change the value in the TENSION display (2).

- The upper thread tension value which is set will be applied the next time sewing is carried out.

<B. Overall correction>

This function is useful if you would like to change the tension values for all programs at once.

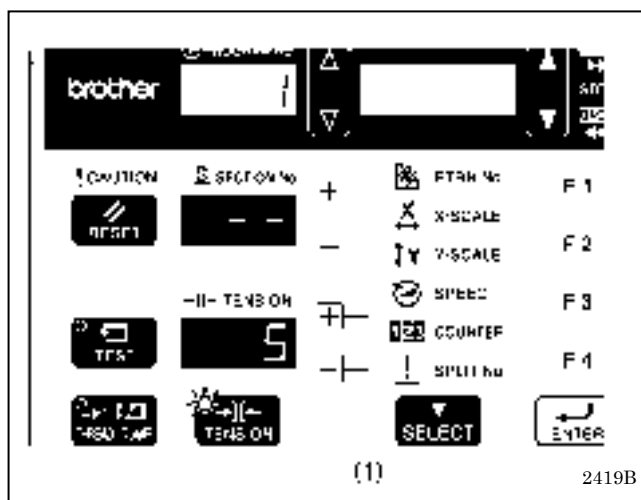

1. Press the TENSION key.
 - The TENSION indicator will illuminate.
 - The overall correction value will be displayed in the TENSION display.

2. Press the \oplus or \ominus key (1) to change the overall correction value in the TENSION display.

- The upper thread tension value which is set will be applied the next time sewing is carried out.







- * The upper thread tension which matches the overall correction value which has been set for the upper thread tension will be applied during sewing, regardless of whether the TENSION indicator is illuminated or switched off.

(In this case, the setting value of “76” which was set in <A. Basic method of use> has the setting value of “5” added to it in <B. Overall correction> so that the upper thread tension applied will be “81”.)

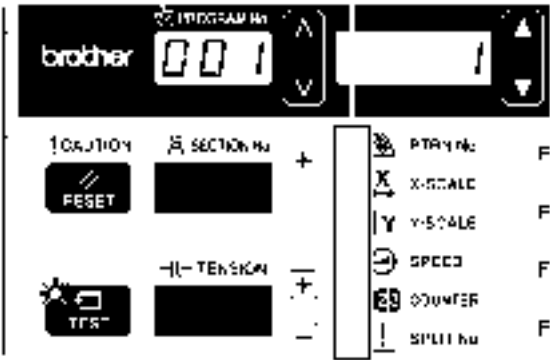
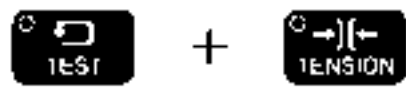
2382B 2383B

6. USING THE OPERATION PANEL (ADVANCED OPERATIONS)

6-1. Setting memory switches

1	<p>Change the mode to memory switch setting mode.</p> <p>All indicators switch off</p>  <p>Menu indicator switches off, TEST indicator flashes</p>	<p>While pressing the TEST key, press the TENSION key.</p>  <ul style="list-style-type: none"> The memory switch number will be displayed in the PROGRAM No. display and the setting value for that number will be displayed in the menu display. <p>2420B 2421BB</p>
2	<p>Select the memory switch that you would like to change the setting for.</p> 	<p>Press the Δ or ∇ key to select the memory switch number.</p> <p>2422B</p>
	<p>If you would like to display only the numbers of memory switches that have been changed from default settings</p>  <p>(1)</p>	<p>While pressing the SELECT key, press the Δ or ∇ key (1).</p> <ul style="list-style-type: none"> The numbers of memory switches that have been changed from default settings will appear in order. <p>2423B</p>
3	<p>Change the memory switch parameters.</p> 	<p>Press the Δ or ∇ key to change the setting value.</p> <ul style="list-style-type: none"> The flashing display means that the setting has not yet been applied. You can make the initial setting appear in the display by pressing the RESET key. <p>2424B</p>
4	<p>Apply the changed parameter setting.</p>  <p>2414B</p>	<p>Press the ENTER key.</p> <ul style="list-style-type: none"> The menu display will change from flashing to illuminated, and this means that the parameter setting has been applied. If you press the Δ or ∇ key (1) or the TEST key without pressing the ENTER key, you can cancel the parameter changes.
5	<p>Repeat steps 2 to 4 above to set each memory switch.</p>	
6	<p>Exit setting mode.</p>  <p>TEST indicator switches off</p>	<p>Press the TEST key.</p> <ul style="list-style-type: none"> The changes will be memorized and the sewing machine will switch to home position detection standby. <p>2404B</p>

6-2. List of memory switches

No.	Setting range	Setting items	Default
001		Work clamp/button clamp lift timing when sewing is complete	1
	OFF	Does not lift automatically.	
	1	Lifts at the final stitch position.	
	2	Lifts after moving to the home position.	
100		Sewing start speed	ON
	OFF	The sewing speed for the first 1 - 5 stitches is set by memory switch nos. 151 - 155. (Refer to the Service Manual for details of memory switch nos. 151 - 155.)	
	ON	The speed increases slowly. The slow start pattern can be selected in program mode.	
200		Single-stitch test feed	*1
	OFF	Test feed starts when the foot switch is depressed, and it continues automatically until the final stitch.	
	ON	Test feeding is carried out stitch by stitch when the foot switch is depressed. In addition, when the test indicator is illuminated, test feeding will move forward one stitch at a time when the machine pulley is turned by hand.	
300		Production counter display	OFF
	OFF	Lower thread counter display	
	ON	Production counter display	
401		Button hole distance display (*2)	OFF
	OFF	X-scale and Y-scale will be displayed as pattern outer dimensions (mm).	
	ON	X-scale and Y-scale will be displayed as button hole distances (mm).	
402		X-scale/Y-scale mm display (*3)	OFF
	OFF	Displayed as %.	
	ON	Displayed as mm.	
404		Display for program numbers 1 to 89 (1 to 64 for BE-438)	ON
	OFF	Program numbers 1 to 89 (1 to 64 for the BE-438) are skipped during program number selection operations so that these numbers cannot be selected. (*4)	
	ON	Program numbers 1 to 89 (1 to 64 for the BE-438) are displayed during program number selection operations.	
405		Cycle program numbers (C01 to C30)	ON
	OFF	Cycle program numbers are skipped during program number selection operations so that these numbers cannot be selected.	
	ON	Cycle program numbers are displayed during program number selection operations.	
406		Program numbers switched by F keys	0
	0	When the F1 to F4 keys are pressed, operation switches to program numbers 1 to 4.	
	1	When the F1 to F4 keys are pressed, operation switches to program numbers 201 to 204.	
	2	When the F1 to F4 keys are pressed, operation switches to cycle program numbers C01 to C04.	
	3	When the F1 to F4 keys are pressed, operation switches to the program number which has been pre-assigned to the respective key. Assignment to F1 key: Memory switch No. 407 Assignment to F2 key: Memory switch No. 408 Assignment to F3 key: Memory switch No. 409 Assignment to F4 key: Memory switch No. 410	

*1: Off for KE-430FX·FS and ON for BE-438FX.

*2: The setting is enabled when memory switch No. 402 is set to "ON" and (for the BE-438FX) when pattern No. 1 to No. 64 (button hole data) is selected.

*3: The mm display may differ slightly from the actual sewing size.

*4: If none of program numbers 200 to 999 or cycle program numbers C01 to C30 have been programmed, this setting is invalid. (Operation occurs as though the setting is 'ON'.)

6. USING THE OPERATION PANEL (ADVANCED OPERATIONS)



No.	Setting range	Setting items	Default
407	Assignment to F1 key	If memory switch No. 406 = 3, operation switches to the program number which has been set.	1
	1 to 999, C01 to C30		
408	Assignment to F2 key	If memory switch No. 406 = 3, operation switches to the program number which has been set.	Assignment to F1 key
	1 to 999, C01 to C30		
409	Assignment to F3 key	If memory switch No. 406 = 3, operation switches to the program number which has been set.	3
	1 to 999, C01 to C30		
410	Assignment to F4 key	If memory switch No. 406 = 3, operation switches to the program number which has been set.	4
	1 to 999, C01 to C30		
500	Thread nipper device		OFF
	OFF	Disable	
	ON	Thread nipper device can be used. (*5)	

*5: The setting is enabled when memory switch No. 100 is set to "ON", the slow start pattern is set to Lo8 or Lo9 and when the sewing speed value is set to 1500 sti/min or more.

6-3. Using the lower thread counter

If you use the lower thread counter to set the number of articles which can be sewn with the amount of lower thread available, you can stop the lower thread running out in the middle of sewing a pattern.

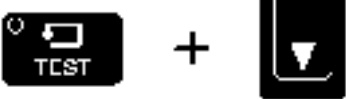
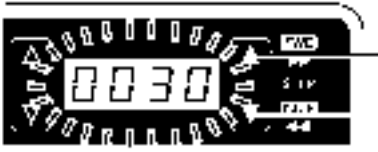
<Initial value setting>

<p>1</p>	<p>Change the mode to lower thread counter setting mode.</p>  <p>TEST indicator and COUNTER indicator flash</p>	<p>While pressing the TEST key, press the ▼ key.</p>  <ul style="list-style-type: none"> The initial value which was set previously will appear in the menu display. <p>2425B 2426B</p>
<p>2</p>	<p>Change the initial value.</p>  <p>2427B</p>	<p>Press the ▲ or ▼ key (1) to set the initial value.</p> <ul style="list-style-type: none"> The initial value can be set from 1 ("0001") to 9999 ("9999"). If the initial value is set to "0000", the lower thread counter will not operate. If you press the RESET key, the setting will become "0000". If the value is changed, the display will change to flashing.
<p>3</p>	<p>Apply the changed parameter setting.</p>  <p>2414B</p>	<p>Press the ENTER key.</p> <ul style="list-style-type: none"> The value will be applied and the display will change to illuminated. If you press the TEST key without pressing the ENTER key, you can cancel the parameter changes.
<p>4</p>	<p>Ending setting mode</p>  <p>TEST indicator switches off</p>	<p>Press the TEST key.</p> <p>2404B</p>

<Lower thread counter operation>

If the initial value is set to other than "0", the lower thread counter will operate. (It operates even if the lower thread counter display is not active.)



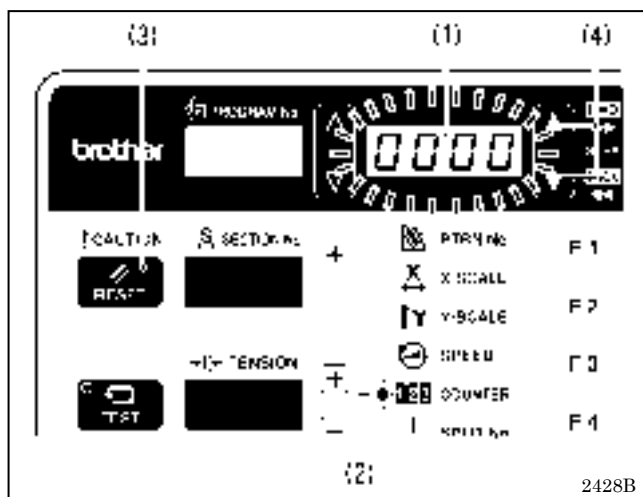

If you press the SELECT key so that the COUNTER indicator illuminates, the current counter value will be displayed in the menu display (1).

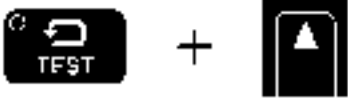

- Each time the sewing of a single article is completed, the value shown in the menu display (1) is reduced by 1.
- If the lower thread counter becomes "0000", the menu display (1) and the COUNTER indicator (2) will flash and a buzzer will sound. The sewing machine will not operate during this time, even if the foot switch is depressed.
- When you press the RESET key (3), the initial value for the lower thread counter will appear in the menu display (1) and sewing will be possible.
 - You can press the ▲ or ▼ key (4) to set the lower thread counter to the desired value. However, this value will not be memorized as the initial value.
 - If you press the RESET key (3) for 2 seconds or more, you can return the lower thread counter to its initial value even if the current value is not "0000".

6-4. Using the production counter

<Setting the counter value>

<p>1</p>	<p>Change the mode to production counter setting mode.</p>  <p>SPEED indicator illuminates TEST indicator and COUNTER indicator illuminate</p>	<p>While pressing the TEST key, press the ▲ key.</p>  <ul style="list-style-type: none"> The 7 digits of the current counter value will be displayed in the PROGRAM No. display and the menu display. <p>2429B 2430B</p>
<p>2</p>	<p>Change the counter value.</p>  <p>For example, 1,234,500.</p>	<p>Press the ▲ or ▼ key (1) to set the counter value.</p> <ul style="list-style-type: none"> The counter value can be set from [000][0000] to [999][9999]. If you press the RESET key during setting mode, the value will become [000][0000]. If the value is changed, the display will change to flashing. <p>2431B</p>
<p>3</p>	<p>Apply the changed parameter setting.</p>  <p>2414B</p>	<p>Press the ENTER key.</p> <ul style="list-style-type: none"> The value will be applied and the display will change to illuminated. If you press the TEST key without pressing the ENTER key, you can cancel the parameter changes.
<p>4</p>	<p>Ending setting mode</p>  <p>TEST indicator switches off</p>	<p>Press the TEST key.</p> <p>2404B</p>

<Production counter operation>

The production counter is always operating. (It operates even if the production counter display is not active.) If you press the SELECT key so that the COUNTER indicator illuminates when memory switch No. 300 is 'ON', the current production counter value will be displayed in the menu display instead of the lower thread counter value. (The SPEED indicator will also illuminate at this time.)

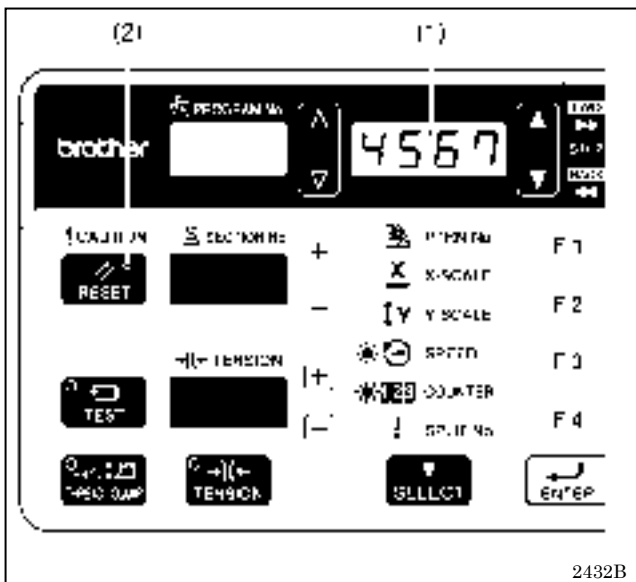

1. The counter is incremented by 1 each time one sewing operation is complete. If the production counter display is active, the number being displayed in the menu display (1) will be incremented by 1.

* If you would like the digits to be displayed in all columns, use the temporary display function described below.

* If you press the RESET key (2) for 2 seconds or more, the counter value can be reset to [0000].

Temporary display function

• While pressing the ENTER key, press the F1 key. The production counter will be displayed as 7 digits while the keys are being pressed.

• While pressing the ENTER key, press the F2 key. The lower thread counter will be displayed while the keys are being pressed.









6-5. Using cycle programs

Sewing patterns that have been recorded in user programs can be recorded in up to 30 cycle programs (C01 to C30).

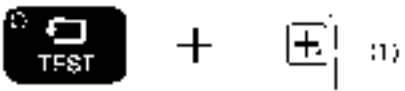
One cycle program can contain up to a maximum of 50 steps (St1 to St50).

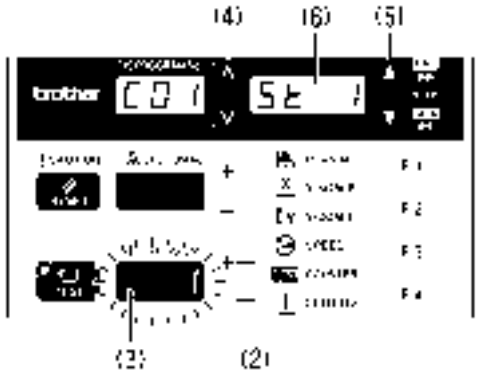
When sewing the sewing patterns in a certain order, it can be useful to record them in a cycle program beforehand.

<Recording method>

<p>1</p>	<p>Switch to cycle program recording mode.</p>  <p>2435B TEST indicator flashes</p>	<p>While pressing the TEST key, press the  key (1).</p>  <p>2436B 2382B</p> <ul style="list-style-type: none"> The cycle program number (C01 to C30) will be displayed in the PROGRAM No. display, the step number (St1 to St50) will be displayed in the menu display, and the program number will be displayed in the TENSION display. If no program has been recorded for a step, '---' will be displayed for that step.
<p>2</p>	<p>Select a cycle program number.</p>  <p>2437B TEST indicator flashes</p>	<p>Press the Δ or ∇ key to select the cycle program number that you would like to use.</p> <ul style="list-style-type: none"> 'St 1' will be displayed.
<p>3</p>	<p>Select the program number to be recorded in step 1.</p>  <p>2438B 2382B 2383B TEST indicator flashes</p>	<p>Press the  or  key (2) to display the program number to be recorded in the TENSION display (3).</p> <ul style="list-style-type: none"> If the value is changed, the display will change to flashing. To cancel the recording, keep the RESET key pressed for more than 2 seconds so that '---' is displayed.
<p>4</p>	<p>Apply the program setting.</p>	<p>Press the ENTER key.</p>  <p>2414B</p> <ul style="list-style-type: none"> The display will change from flashing to illuminated, and this means that the setting has been applied. If you press the Δ/∇ keys (4), the $\blacktriangle/\blacktriangledown$ keys (5) or the TEST key without pressing the ENTER key, you can cancel the parameter changes.

5	Repeat steps 3 and 4 above to record step 2 and subsequent steps in the same way.	Press the ▲ or ▼ key (5) to display the step number you would like to record in the menu display (6).
6	If you would like to continue setting another cycle program, repeat steps 2 to 5 above.	
7	<p>End cycle program recording mode.</p>  <p>2404B</p>	<p>Press the TEST key.</p> <p>This completes the recording of cycle programs.</p> <p>TEST indicator switches off</p>

6. USING THE OPERATION PANEL (ADVANCED OPERATIONS)

<Method of use>

When a cycle program has been recorded, the cycle program number is displayed after the program number when a program number is selected.

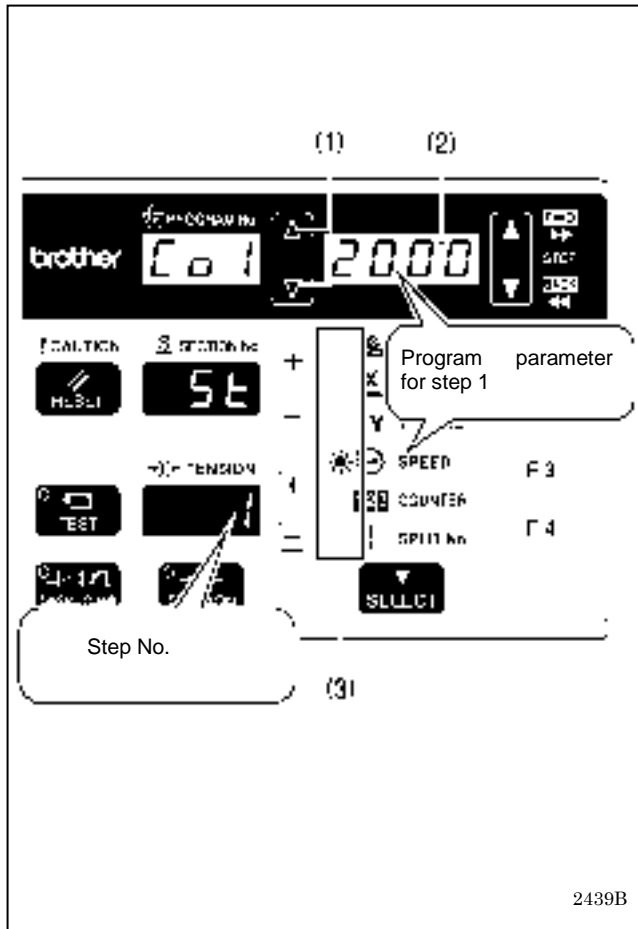

2439B

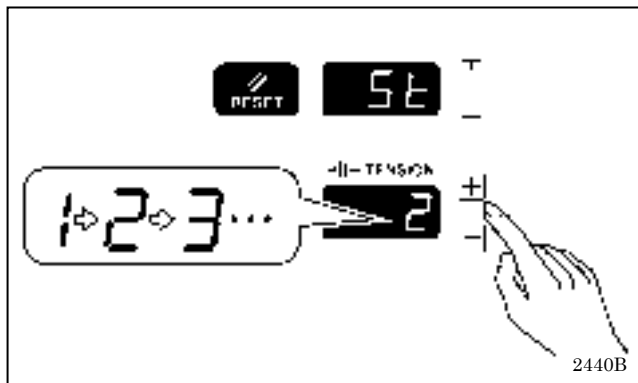

2440B

1. Press the Δ or ∇ key (1) to select the cycle program number that you would like to use.
 - The order of displays is as follows.

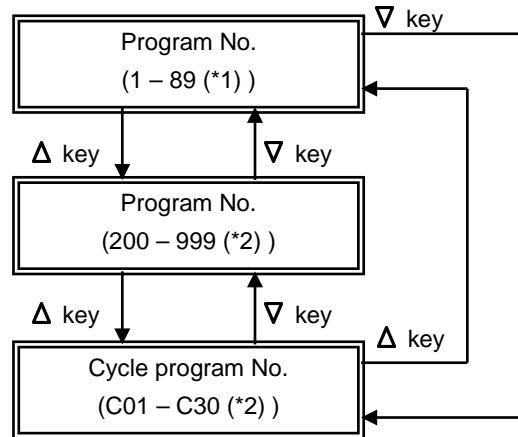

*1: 1 to 64 for the 438FX

*2: Only the numbers which have been recorded are displayed.

- The cycle program number is displayed in the PROGRAM No. display, the step number is displayed in the TENSION display, and the parameter for that step is displayed in the menu display (2).
- When you press the SELECT key, the menu display (2) and the menu indicator (3) are switched, so that you can check the program parameters for that step.

2. Carry out sewing while referring to "7. Sewing".

- The recorded programs are carried out in the order of the steps, and when the last step is completed, sewing returns to the first step.
- If you press the \oplus or \ominus key, you can return to the previous step or skip to the next step respectively. (You do not need to carry out home position detection again.)

2382B 2383B

(Continued on next page)

The range of programs that can be selected and the order of the displays may change depending on the memory switch settings.

Memory switch

Range of programs and display order

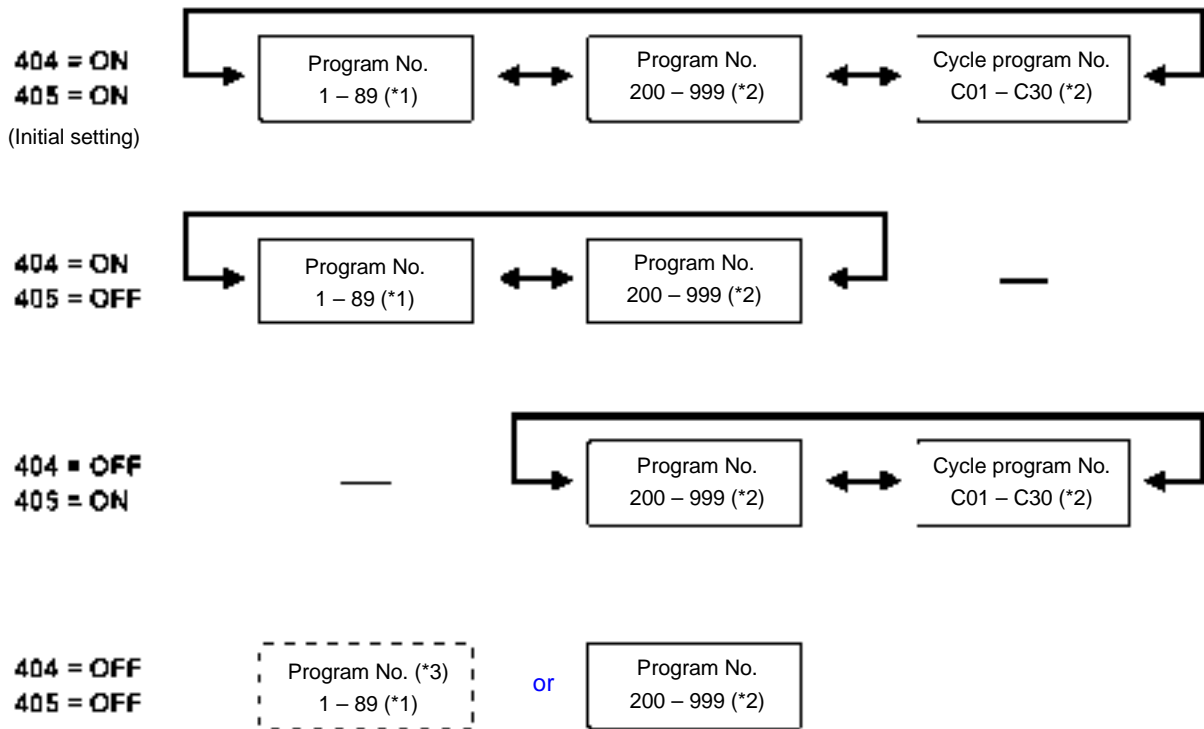

*1: 1 to 64 for the 438FX

*2: Only the numbers which have been recorded are displayed.

*3: Only when program numbers 200 to 999 have not been recorded.

6-6. Direct selection

You can use the function keys to directly select program numbers and cycle program numbers. **However, if a program number has nothing recorded, it will not be displayed.**

<Function keys>

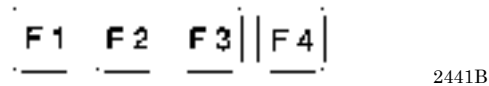

The parameters which can be selected will vary depending on the memory switch settings.

406 = 0 (Initial setting)

Program No. 1 <div style="text-align: center;">F 1</div> <div style="text-align: right;">2442B</div>	Program No.2 <div style="text-align: center;">F 2</div> <div style="text-align: right;">2443B</div>	Program No.3 <div style="text-align: center;">F 3</div> <div style="text-align: right;">2444B</div>	Program No.4 <div style="text-align: center;">F 4</div> <div style="text-align: right;">2445B</div>
---	--	--	--

406=1

Program No.201 <div style="text-align: center;">F 1</div> <div style="text-align: right;">2442B</div>	Program No.202 <div style="text-align: center;">F 2</div> <div style="text-align: right;">2443B</div>	Program No.203 <div style="text-align: center;">F 3</div> <div style="text-align: right;">2444B</div>	Program No.204 <div style="text-align: center;">F 4</div> <div style="text-align: right;">2445B</div>
--	--	--	--

406=2

Program No.C01 <div style="text-align: center;">F 1</div> <div style="text-align: right;">2442B</div>	Program No.C02 <div style="text-align: center;">F 2</div> <div style="text-align: right;">2443B</div>	Program No.C03 <div style="text-align: center;">F 3</div> <div style="text-align: right;">2444B</div>	Program No.C04 <div style="text-align: center;">F 4</div> <div style="text-align: right;">2445B</div>
--	--	--	--

406=3

Item specified by memory switch No. 407 <div style="text-align: center;">F 1</div> <div style="text-align: right;">2442B</div>	Item specified by memory switch No. 408 <div style="text-align: center;">F 2</div> <div style="text-align: right;">2443B</div>	Item specified by memory switch No. 409 <div style="text-align: center;">F 3</div> <div style="text-align: right;">2444B</div>	Item specified by memory switch No. 410 <div style="text-align: center;">F 4</div> <div style="text-align: right;">2445B</div>
---	---	---	---

6-7. Resetting all settings to their defaults

If the sewing machine stops operating normally, the cause may be that an incorrect setting may have been made for the memory data by means of memory switches, for instance. In such cases, it may be possible to restore normal operation by following the steps given below to initialize the memory setting data.

1 Change to initialization mode.

2446B



(While pressing the RESET key, press the power ON switch.)

'1' will be displayed in the PROGRAM No. display, and 'ALL' will be displayed in the menu display.

[Reference]

If the Δ or ∇ key (1) is pressed at this time, you can select the items to be initialized as shown below.

* For details on initialization items other than "init ALL", refer to the service manual.

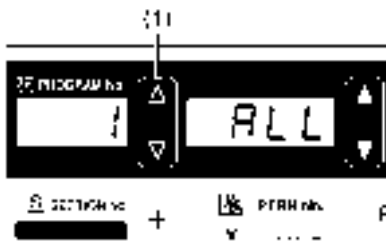

PROGRAM No. display	Main display	Initialization item
1	「ALL」	All data in memory is cleared or initialized. (*3)
2	*1	The values for each parameter in program No. 1 to 199 set as described in "5-2. Program setting method" are initialized.
3	*2	Program numbers 200 to 999 are cleared.
4	「PALL」	All programs are cleared or initialized.
5	「CYCL」	Cycle programs are cleared.
6	「MEM」	Memory switches are initialized.
7	「PDAT」	Additional patterns are cleared.

*1: P001 and P199 are displayed alternately.

*2: P200 and P999 are displayed alternately.

*3: Additional patterns will also be cleared, so check that a backup exists before clearing them.

2447B 2138M 2139M

2



Press the ENTER key for two seconds or more.

- The menu display will change to illuminated and initialization will then be complete.

2448B

3



Press the TEST key.

2404B

7. SEWING

CAUTION



Turn off the power switch at the following times, otherwise the machine may operate if the foot switch is depressed by mistake, which could result in injury.

- When replacing the needle and bobbin
- When not using the machine and when leaving the machine unattended



Use threading mode or turn off the power first in order to carry out threading.



Do not touch any of the moving parts or press any objects against the machine while sewing, as this may result in personal injury or damage to the machine.

7-1. Sewing

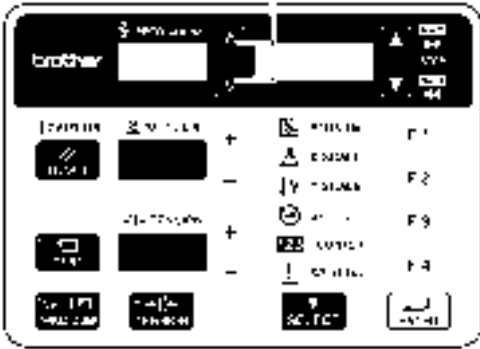

(1)

2342B

1. Turn on the power switch.
2. Press the Δ or ∇ key (1) to select the number for the program to be sewn.

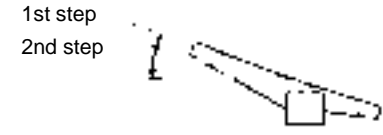

1st step
2nd step

4441Q

3. Depress the foot switch to the 2nd step.
The feed mechanism will move to the home position.
4. Set the material under the work clamp (2).
(For the BE-438FX, insert the button and place the material under the button clamp (3). (Refer to "4-7. Inserting the button".))
5. Depress the foot switch to the 1st step.
The work clamp (2) / button clamp (3) will be lowered.
6. Depress the foot switch to the 2nd step.
The sewing machine will start sewing.

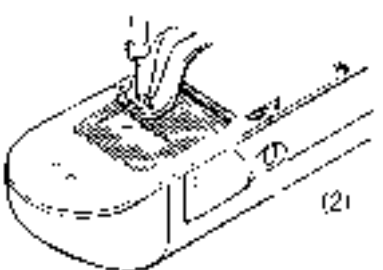

(2)

2384B

7. Once sewing is completed and the thread has been trimmed, the work clamp (2) / button clamp (3) will rise.

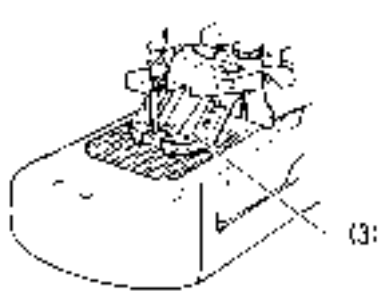

(3)

4116M

55

KE-430FX/KE-430FS, BE-438FX

7-2. Changing sewing conditions

"X-scale", "Y-scale" and "Sewing speed" can be changed even during sewing standby.

The changes made at this time will be reflected in the program, so this is a useful way of changing programs while checking actual sewing.

<Changing X-scale and Y-scale>

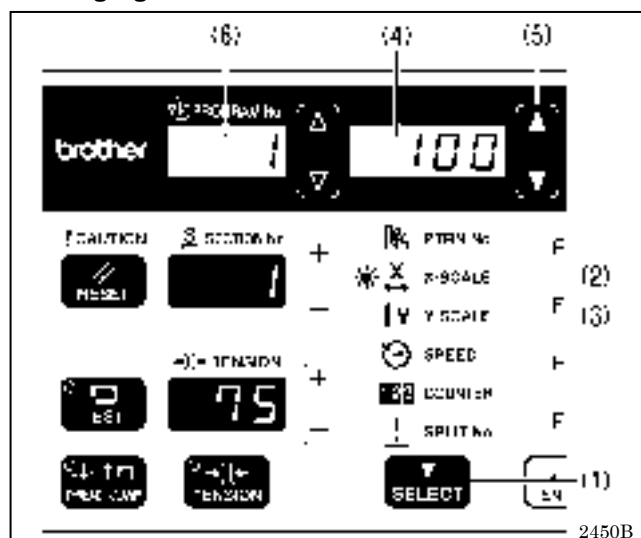

1. Press the SELECT key (1) so that the X-SCALE indicator (2) (for X-scale setting) or the Y-SCALE indicator (3) (for Y-scale setting) is illuminated.
 - The setting value (%) will be displayed in the menu display (4).
2. Press the ▲ or ▼ key (5) to set the scale (20 - 200).
 - The program number in the PROGRAM No. display (6) will flash.
3. Depress the foot switch to the 2nd step.
 - The work clamp will move to the sewing start position and the program number will change from flashing to illuminated.

NOTE:

Once the setting is complete, be sure to carry out the steps in "5-4./5-5. Checking the sewing pattern" to check that the needle drop position is correct.

<Changing the sewing speed>

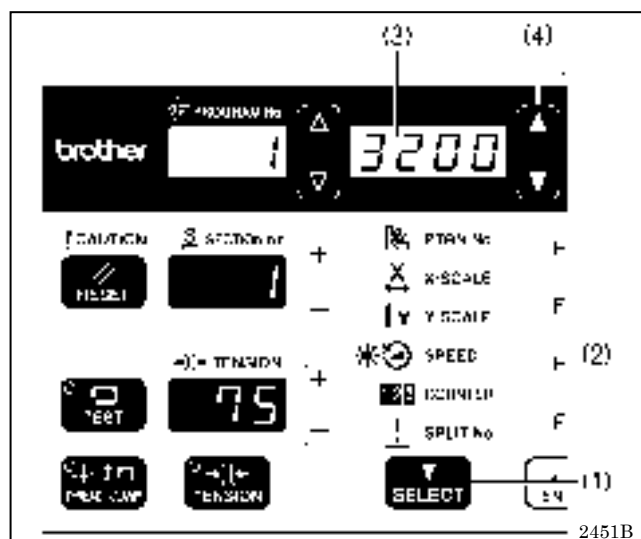

1. Press the SELECT key (1) so that the SPEED indicator (2) is illuminated.
 - The setting value (sti/min) will be displayed in the menu display (3).
2. Press the ▲ or ▼ key (4) to set the sewing speed. (Sewing speed values: KE-430FX·FS: 200 to 3200; BE-438FX: 200 to 2700)

<Changing slow start pattern>

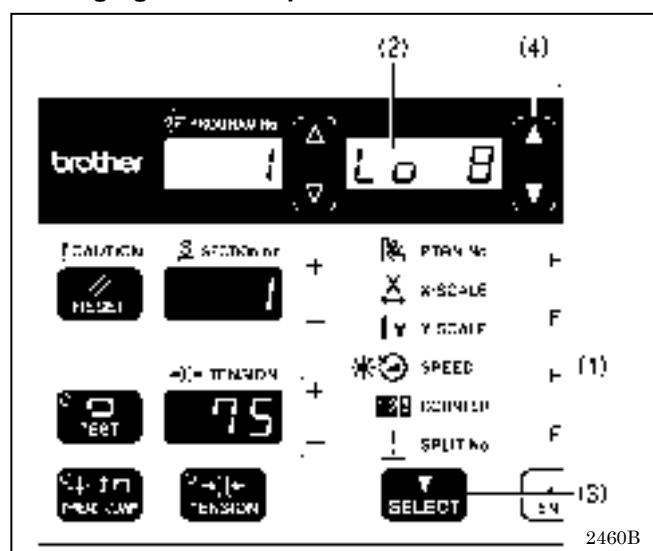

* This setting cannot be made when memory switch No. 100 is set to "OFF".

1. While the SPEED indicator (1) is illuminated and the sewing speed is being displayed in the menu display (2), press the SELECT key (3).
 - The setting value will be displayed in the menu display (2).
2. Press the ▲ or ▼ key (4) to set the slow start pattern.
 - * Refer to the list of parameters in "5-2. Program setting method".

8. MAINTENANCE

⚠ CAUTION



Turn off the power switch before carrying out cleaning, otherwise the machine may operate if the foot switch is pressed by mistake, which could result in injury.



Be sure to wear protective goggles and gloves when handling the lubricating oil and grease, so that they do not get into your eyes or onto your skin, otherwise inflammation can result.

Furthermore, do not drink the oil or eat the grease under any circumstances, as they can cause vomiting and diarrhoea. Keep the oil out of the reach of children.

8-1. Cleaning the rotary hook

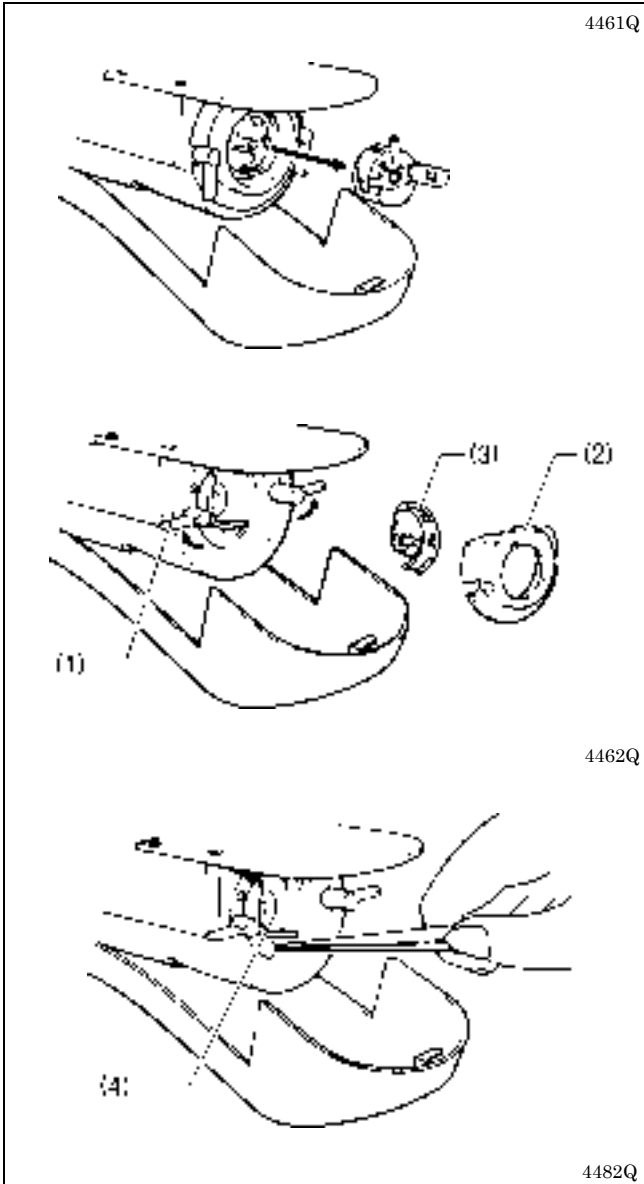

1. Pull the shuttle race cover downward to open it, and then remove the bobbin case.

2. Open the setting claw (1) in the direction indicated by the arrow, and then remove the shuttle race base (2) and the shuttle hook (3).

3. Clean all the dust and thread ends from around the driver (4), the top of the rotary hook thread guide and the shuttle race.

8-2. Cleaning the control box air inlet ports

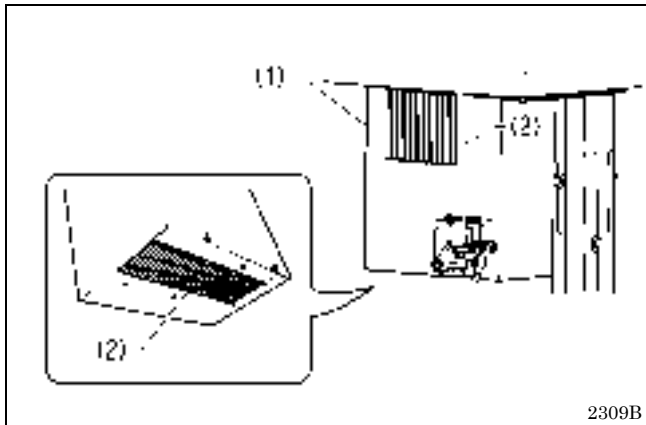

Use a vacuum cleaner to clean the filter in the air inlet ports (2) of the control box (1) at least once a month.

8-3. Draining the oil

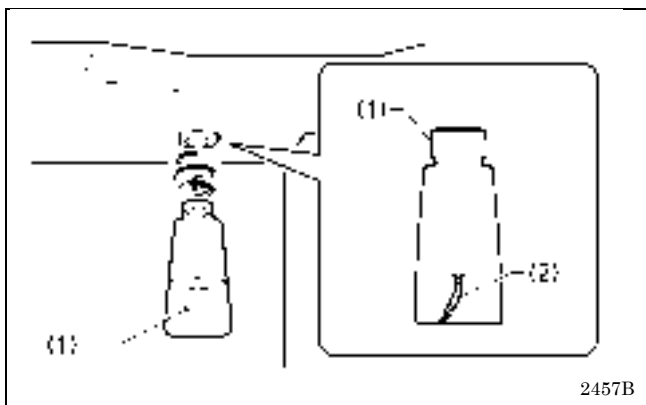

1. Remove and empty the waste oil container (1) whenever it is full.
2. After emptying the waste oil container (1), screw it back into its original position.

* Check that the felt (2) is inside the oiler (1).

8-4. Cleaning the eye guard

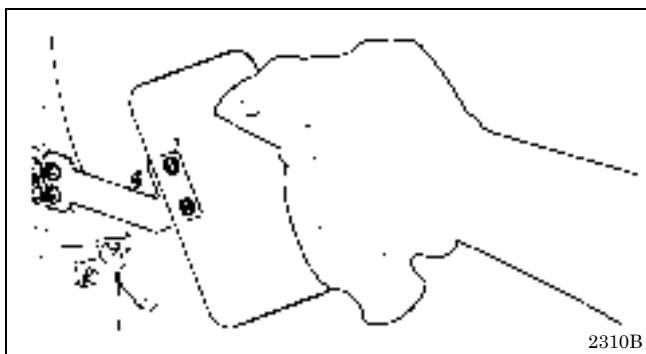

Wipe the eye guard clean with a soft cloth.

NOTE:

Do not use solvents such as kerosene or thinner to clean the eye guard.

8-5. Checking the needle

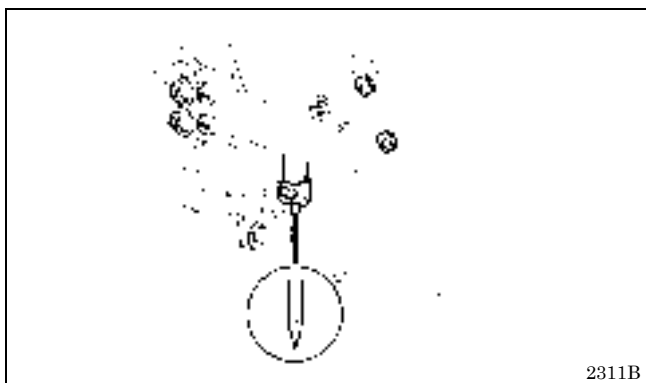

Always check that the tip of the needle is not broken and also the needle is not bent before starting sewing.

8-6. Lubrication

Carry out the lubrication referring to "3-12. Lubrication".

8-7. Applying grease (Work clamp: KE-430FX·FS)

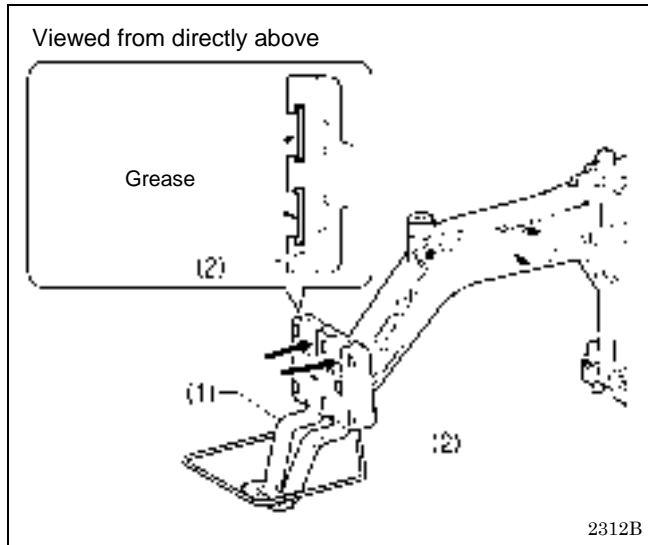

Periodically apply grease to the sliding parts of the work clamp (1) and the work clamp arm (2).

NOTE:

After replacing the work clamp (1), be sure to apply grease before using it.

- * It is recommended that you use commercially-available NIPPON OIL CORPORATION Powernoc WB 2 grease for the work clamp (1).

8-8. Applying grease (When “GREASEUP” appears)

If “GrE” and “AS.UP” flash on the PROGRAM No. display (1) and the menu display (2) respectively, and a buzzer sounds when the power switch is turned on, it means that grease needs to be applied. (The sewing machine will not operate at this time, even if the foot switch is depressed.)

Apply grease as required, while referring to the following for details.

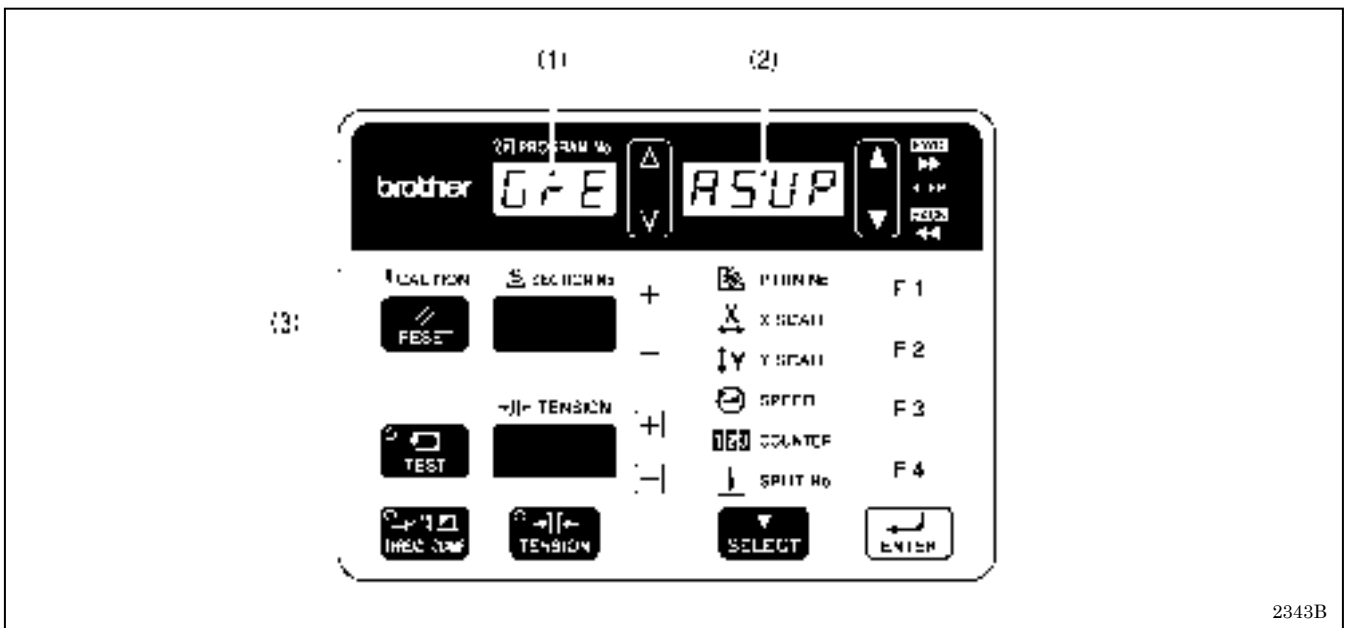

<To continue sewing temporarily without applying grease>

1. Press the RESET key (3).
2. The PROGRAM No. display (1) and the menu display (2) will change to the normal displays, and sewing can be carried out by depressing the foot switch.

Note:

- “GrE” and “AS.UP” will continue to be displayed each time the power is turned on until grease is applied and the notification is reset by carrying out the procedure on page 62.
- If you continue to use the sewing machine after the “GrE” and “AS.UP” notification appears without applying grease (or without carrying out the reset procedure), “E100” will appear after a certain period of time and the sewing machine will be forcibly prevented from operating for safety reasons. If this happens, apply grease and carry out the reset procedure.

- * If you continue to use the sewing machine after carrying out the reset procedure but without applying grease, problems with the sewing machine may result.

<Applying grease>

Use Brother-specified "Grease unit (SB1275-101)".

1. Removing the grease assembly

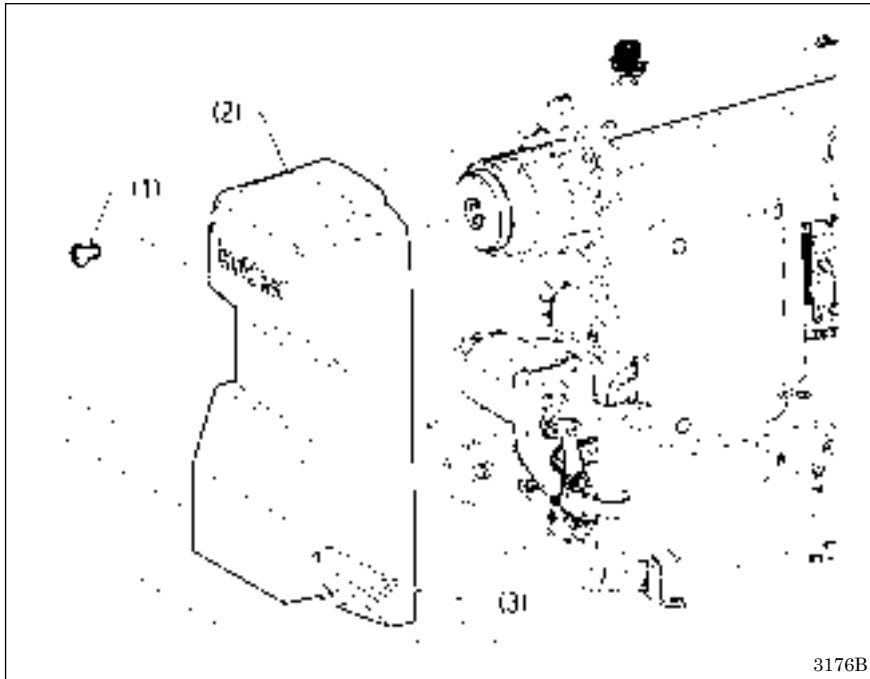

1. Remove the four screws (1), and then remove the rear cover (2).
2. Remove the grease assembly (3) from inside the rear cover (2).

2. Using the tube

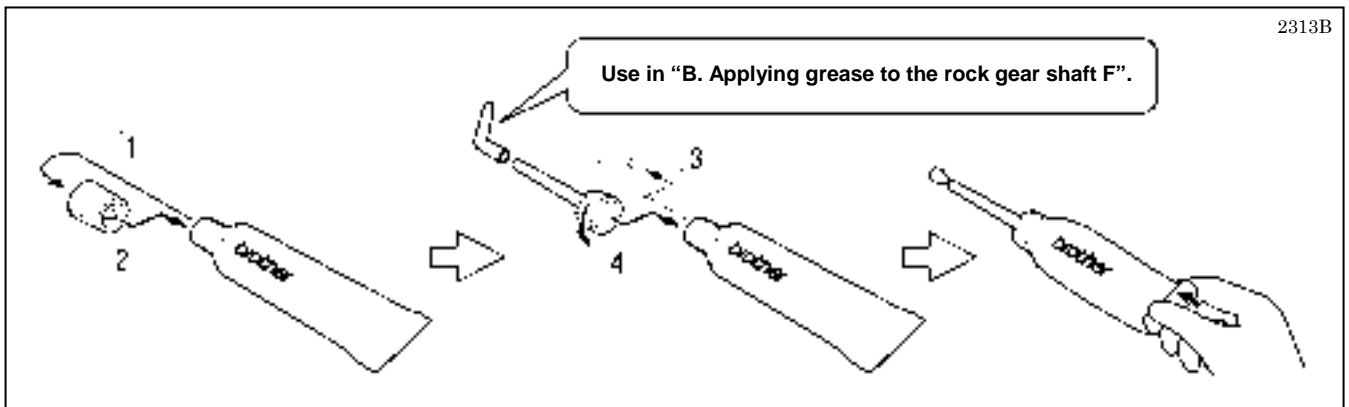

8. MAINTENANCE

3. Applying grease

< A. Applying grease to the eccentric wheel >

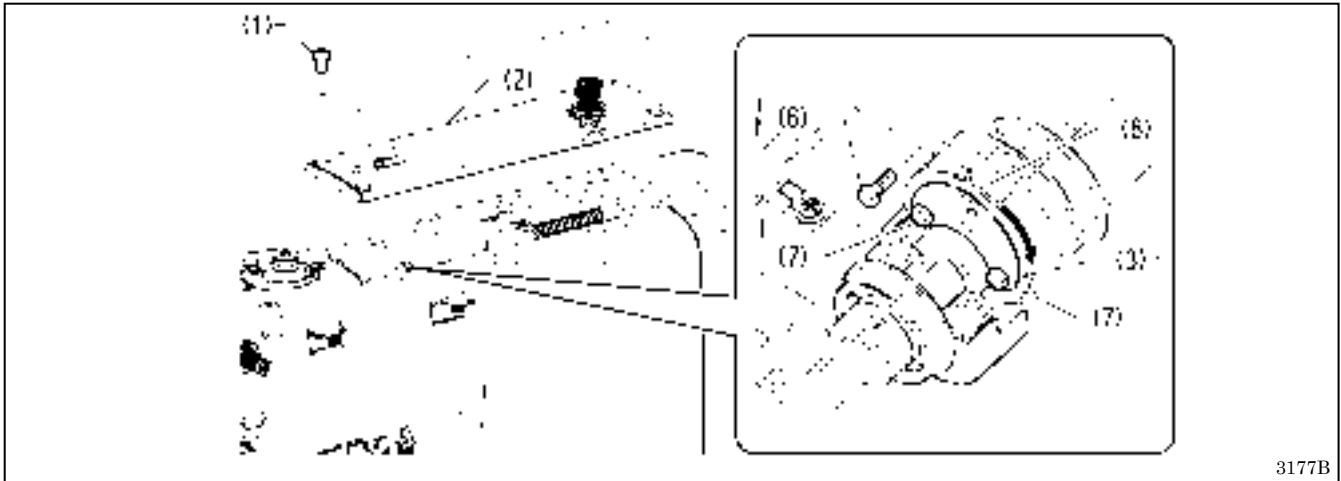

3177B

1. Turn off the power switch.
2. Remove the four screws (1), and then remove the top cover (2).

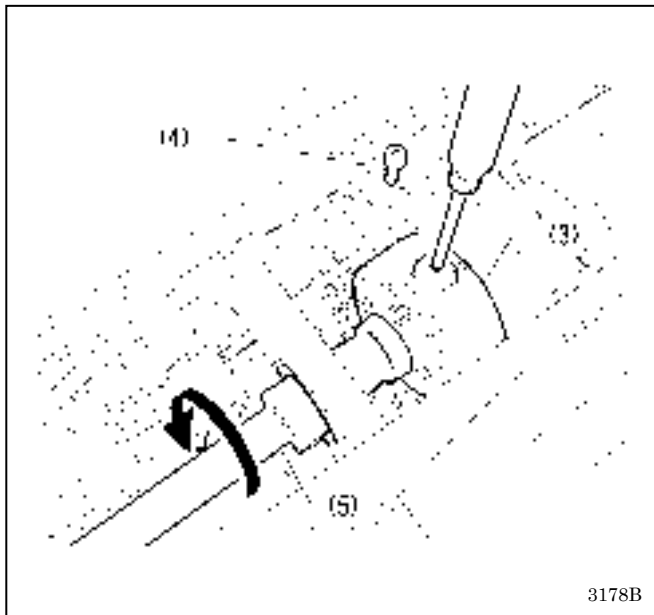

3178B

3. Remove the screw (4) of the eccentric wheel (3).
* Be careful not to drop the screw (4) when removing it.
4. Insert the grease nozzle into the hole in the eccentric wheel (3) as far as it will go, and then apply grease while turning the upper shaft (5) in the direction of the arrow.
* Apply enough grease to make sure that it does not miss any parts.
5. Check that enough grease has been applied so that it is overflowing slightly from the edges.
6. Install the screw (4).
7. Remove the bolt (6) from the eccentric wheel (3).
* Be careful not to drop the bolt (6) when removing it.
8. Loosen the two bolts (7), and slide the grease cover (8) in the direction of the arrow.
* To prevent the bolts (7) from being dropped, do not remove them completely.
9. Wipe away any grease which is remaining inside the eccentric wheel (3).
10. Insert the grease nozzle into the holes in the eccentric wheel (3), and apply the grease.
* Insert the grease nozzle into both holes to apply the grease, in order to make sure that the grease is applied evenly without missing any parts.
11. Check that enough grease has been applied so that it is overflowing slightly from the edges.
12. Return the grease cover (8) to its original position, and then secure it by tightening the bolt (6) and the two bolts (7).

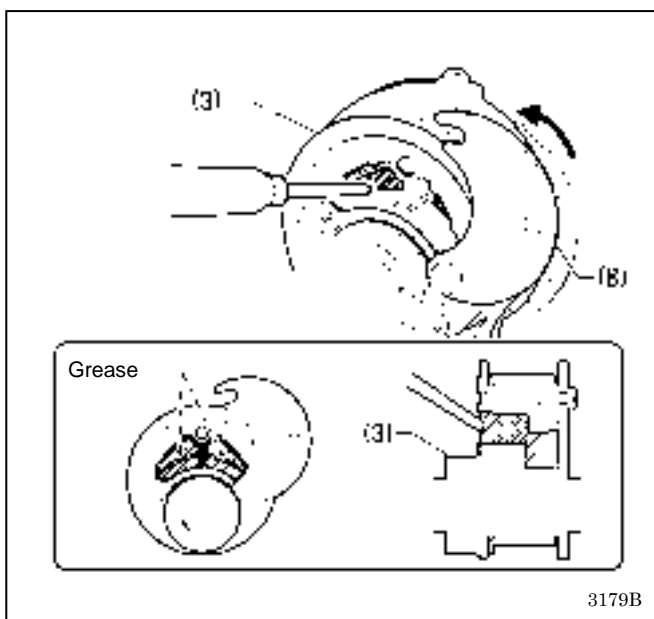

3179B

NOTE:

Securely tighten the bolt (6) and the two bolts (7). If any of these bolts are loose, grease may leak out and problems with sewing machine operation such as seizing may occur.

<B. Applying grease to rock gear shaft F>

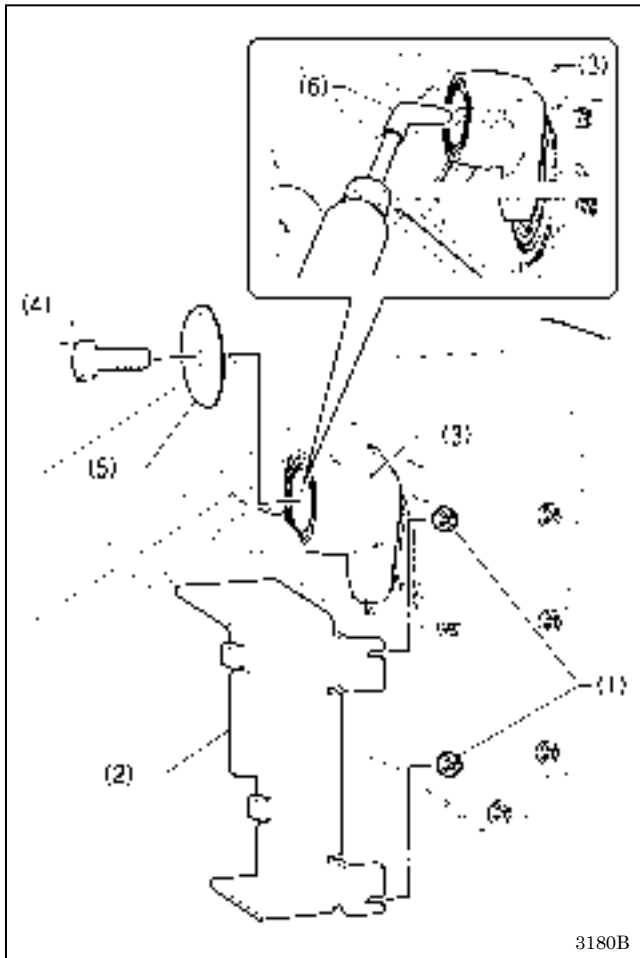

3180B

1. Tilt back the machine head.
2. Loosen the two screws (1), and then remove grease holder F (2). (Never loosen any screws other than the screw (1). If any other screws are loosened, the grease will leak out and this may cause problems with the sewing machine such as seizure.)
3. Turn the pulley to move rock gear shaft F (3) to the most forward position.
4. Remove the bolt (4) and the washer (5).
5. Insert the grease nozzle (6) into the hole in rock gear shaft F (3) as far as it will go as shown in the illustration, and apply grease until it is overflowing slightly from the edges.
6. Pull out the grease nozzle (6) while adding the grease.
7. Install the bolt (4) and the washer (5).
8. Install grease holder F (2) with the two screws (1).
9. Install the rear cover with the four screws.

Note:

- Once the grease tube has been opened, remove the nozzle from the tube, attach the cap securely and store the tube in a cool dark place.
- The grease should be used as quickly as possible.
- When using the grease again, remove any old grease from inside the nozzle first.

(Store the tube away carefully once the tube has been opened, otherwise the grease remaining inside the tube may deteriorate, and this may affect its lubricating performance.)

<Resetting the grease up counter>

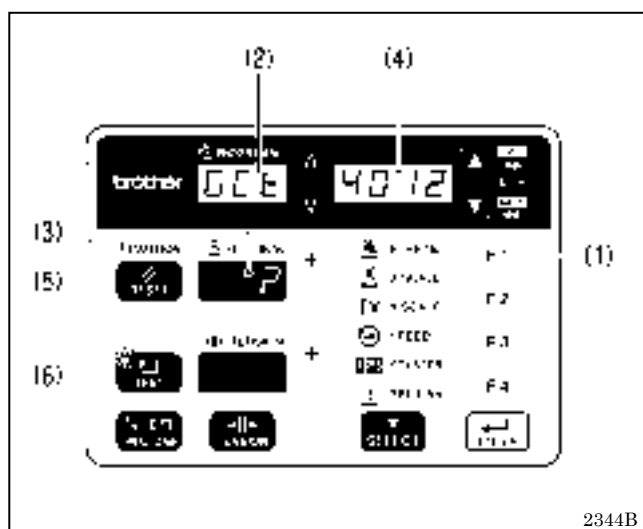

2344B

Once the grease has been applied, follow the procedure below to reset the cumulative number of stitches between grease applications.

1. While pressing the F1 key (1), turn on the power switch. "GCt" will appear in the PROGRAM No. display (2), and the cumulative number of stitches until grease should be applied will be displayed in the total of six columns in the section No. display (3) and the menu display (4) in units of 10,000 stitches.
2. Press and hold the RESET key (5) for 2 seconds or more. (This completes the reset procedure.)
3. When you press the TEST key (6), the displays will return to their normal displays.

9. STANDARD ADJUSTMENT

⚠ CAUTION



Maintenance and inspection of the sewing machine should only be carried out by a qualified technician.



Ask your Brother dealer or a qualified electrician to carry out any maintenance and inspection of the electrical system.



Turn off the power switch and disconnect the power cord from the wall outlet at the following times, otherwise the machine may operate if the foot switch is depressed by mistake, which could result in injury.

- When carrying out inspection, adjustment and maintenance
- When replacing consumable parts such as the rotary hook



Hold the machine head with both hands when tilting it back or returning it to its original position.

Furthermore, after tilting back the machine head, do not push the face plate side or the pulley side from above, as this could cause the machine head to topple over, which may result in personal injury or damage to the machine.



If the power switch needs to be left on when carrying out some adjustment, be extremely careful to observe all safety precautions.



If any safety devices have been removed, be absolutely sure to re-install them to their original positions and check that they operate correctly before using the machine.

9-1. Standard thread tension

Use	KE-430FX·FS				BE-438FX
	Medium-weight materials (-03)	Knitted wear (-0K)	Foundation garments (-0F)	Heavy-weight materials (-05)	
Upper thread	#50 or equivalent	#60 or equivalent	#60 or equivalent	#30 or equivalent	#60 or equivalent
Lower thread	#50 or equivalent	#80 or equivalent	#60 or equivalent	#50 or equivalent	#60 or equivalent
Upper thread tension (N) [Tension value] *1	0.8 - 1.2 [80 - 120]*2			1.2 - 1.8 [70 - 130]*2	0.5 - 1.2 [50 - 150]*2
Lower thread tension (N)	0.2 - 0.3				0.2 - 0.3
Pre-tension (N)	0.05 - 0.3				0.1 - 0.4
Needle	DP x 5 #14	DP x 5 #9	DP x 5KN #11	DP x 17NY #19	DP x 17NY #12

*1: For KE-430FX and BE-438FX.

*2: This is the tension value when the pretension is 0.05 N.

9-1-1. Upper and lower thread tension

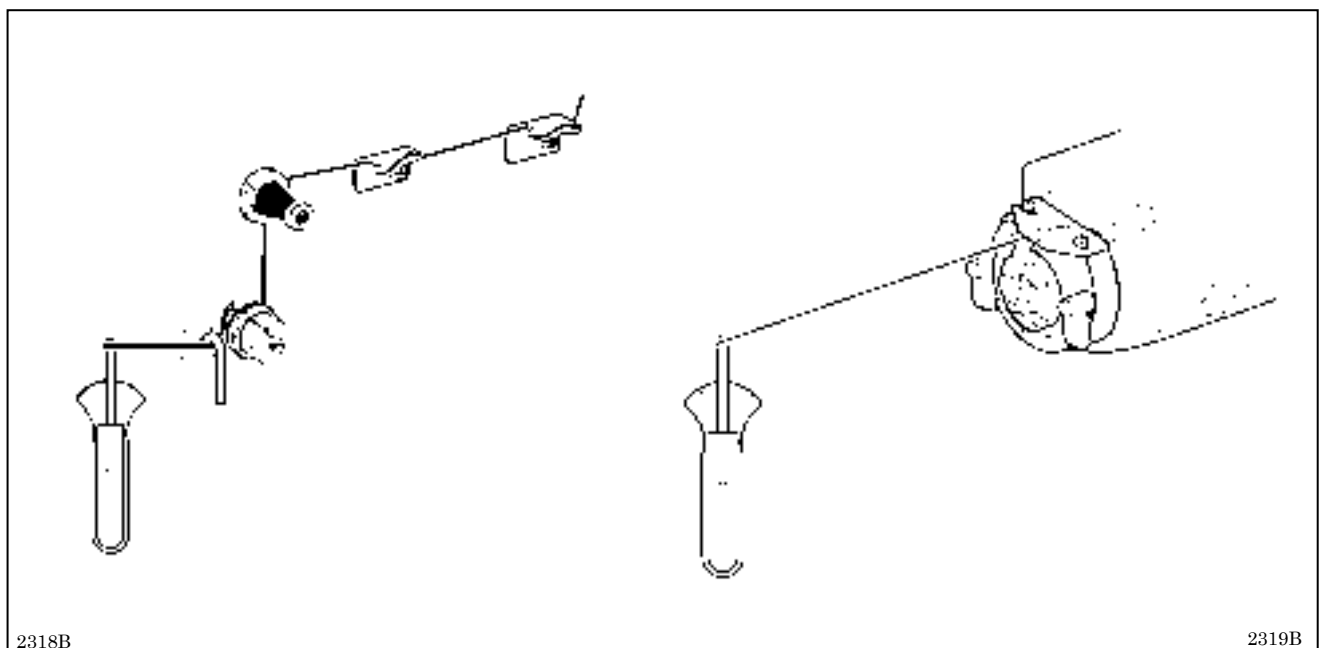

9-1-2. Thread take-up spring

Use	KE-430FX·FS				BE-438FX
	Medium-weight materials (-03)	Knitted wear (-0K)	Foundation garments (-0F)	Heavy-weight materials (-05)	
Thread take-up spring height (mm)	6 - 11				6 - 11
Thread take-up spring tension (N)	0.2 - 0.4		0.6 - 1.0		0.15 - 0.35

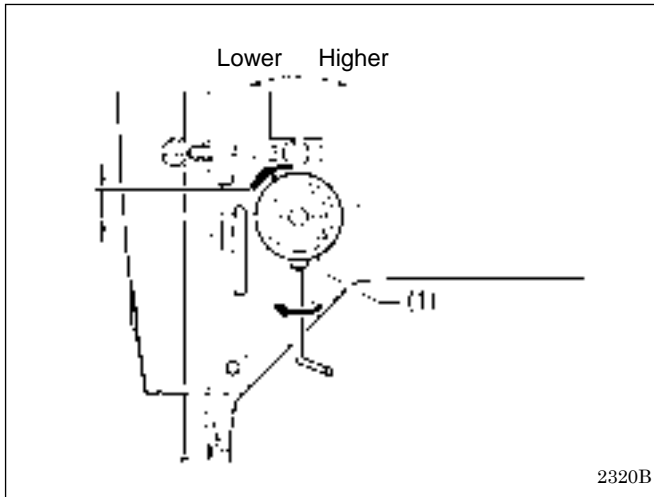

< Thread take-up spring height >

Loosen the set screw (1) and turn the tensioner body to adjust the thread take-up spring height.

< Thread take-up spring tension >

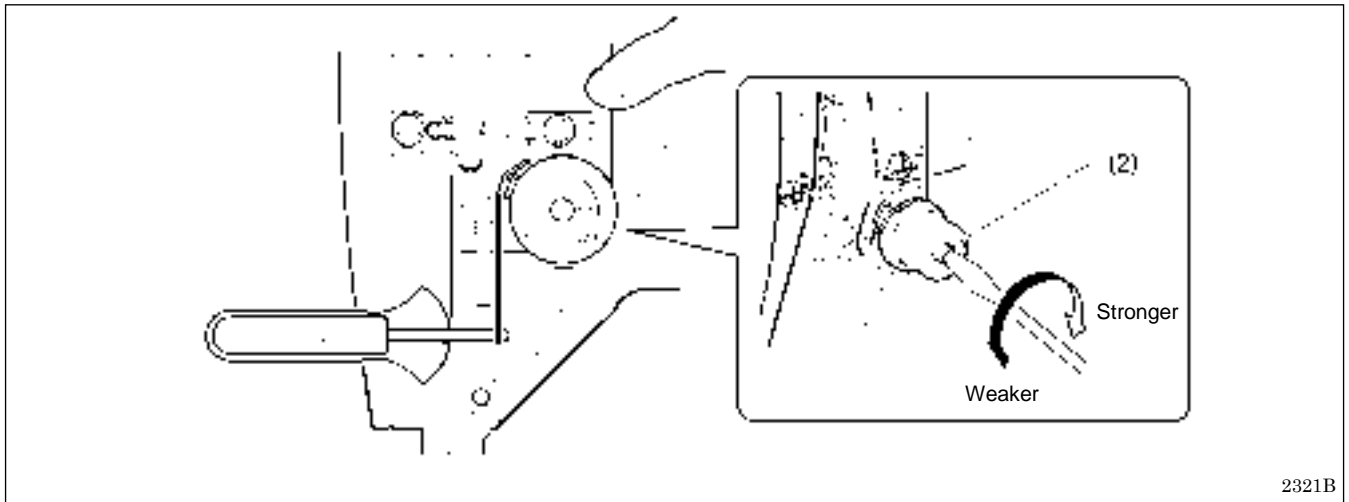

Adjust by turning the shaft (2) with a screwdriver.

* When the spring height (stroke) is great or the spring tension is insufficient, it may cause the thread end length to vary after thread trimming.

9-1-3. Arm thread guide C

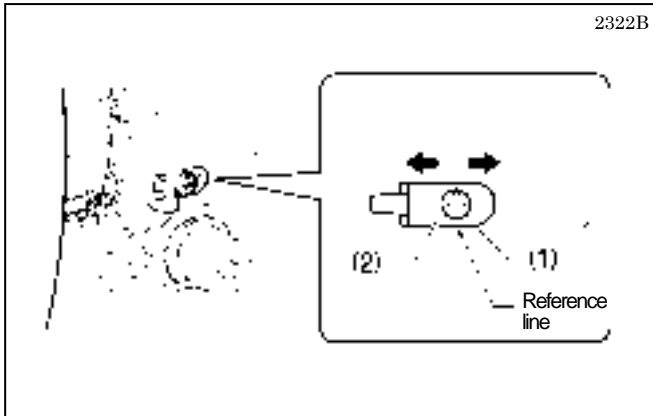

The standard position of arm thread guide C (1) is when the screw (2) is aligned with the position of the reference line. To adjust the position, loosen the screw (2) and then move arm thread guide C (1).

- When sewing heavy-weight materials, move arm thread guide C (1) to the left. (The thread take-up amount will increase.)
- When sewing light-weight materials, move arm thread guide C (1) to the right. (The thread take-up amount will decrease.)

9-1-4. Needle bar bush thread guide D

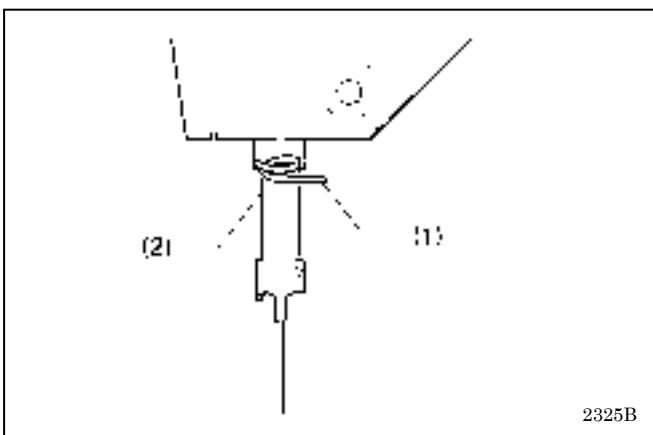

Check that needle bar bush thread guide D (1) is at the middle of the needle bar (2).

NOTE:

If needle bar bush thread guide D (1) is not in the correct position, the thread may pull out or skipped stitches may occur.

9-2. Adjusting the needle bar height

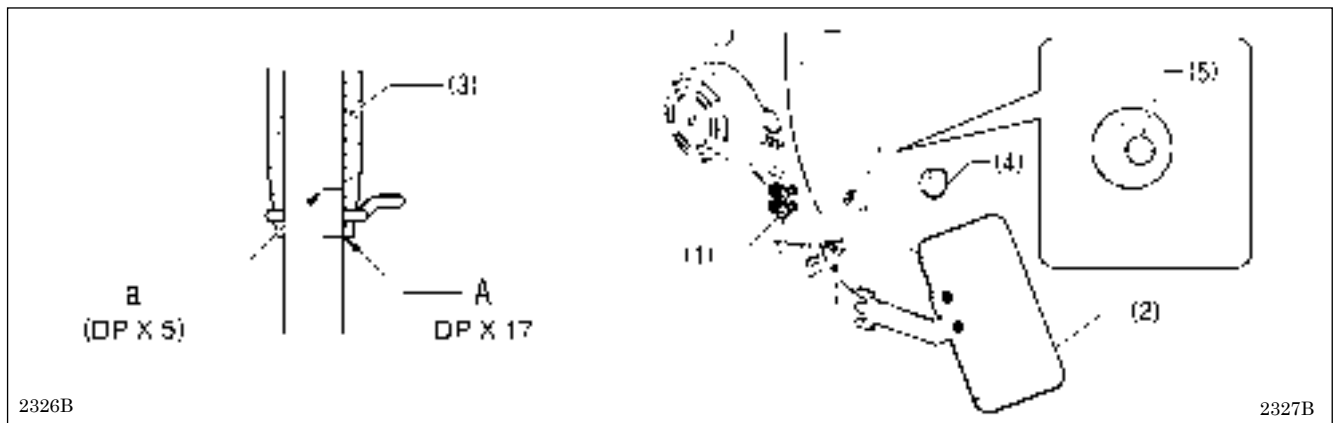

1. Loosen the two screws (1), and then remove the eye guard assembly (2).
 2. Turn the pulley to move the needle bar to the lowest position. Then remove the rubber cap (4), loosen the screw (5) and then move the needle bar up or down to adjust so that the second reference line from the bottom of the needle bar (reference line A) is aligned with the lower edge of the needle bar bush (3).
- * If using a DP x 5 needle, use the highest reference line (reference line a).

9-3. Adjusting the needle bar lift amount and the driver needle guard

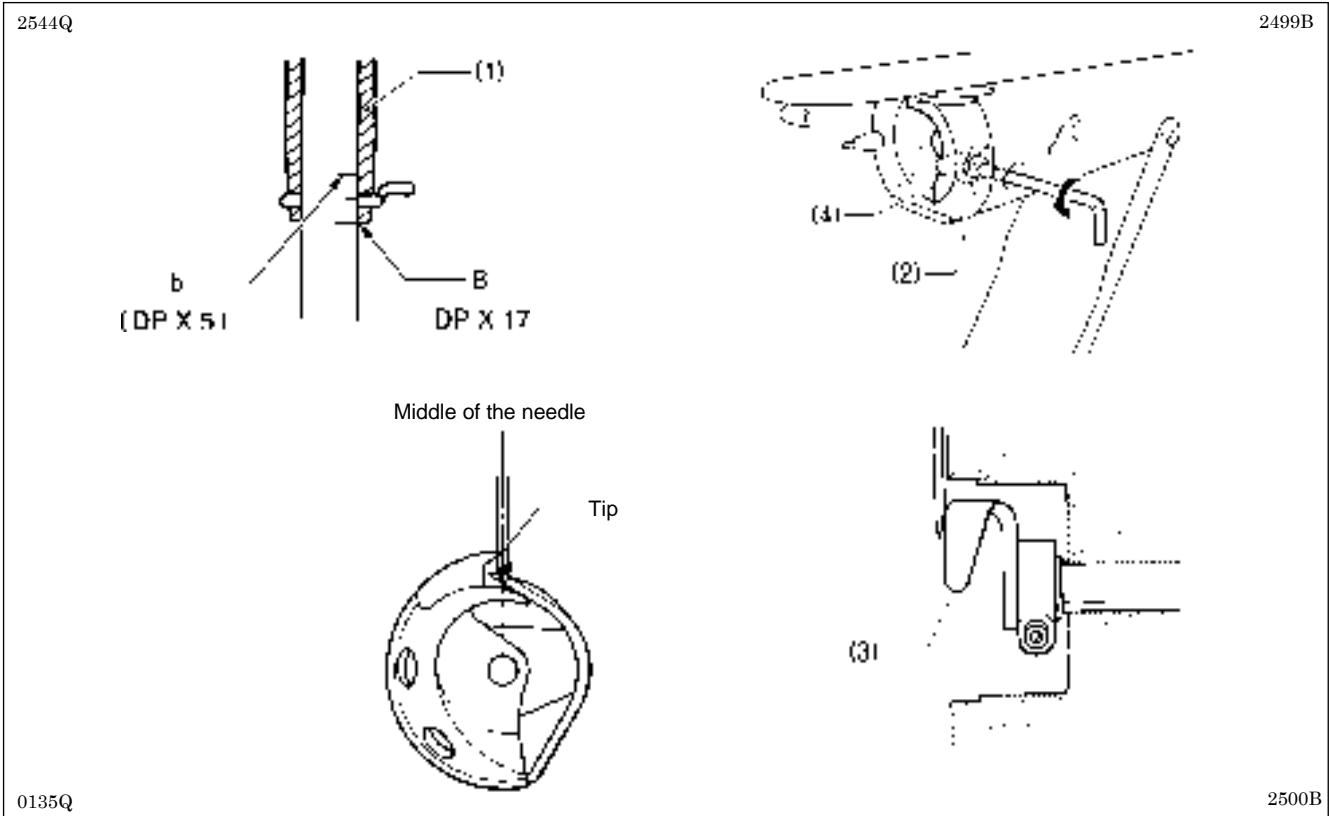

1. Turn the machine pulley to raise the needle bar from the lowest position until the lowest reference line on the needle bar (reference line B) is aligned with the lower edge of the needle bar bush (1).
* If using a DP x 5 needle, align with reference line b which is the second reference line from the top.

Note:

Check that the wiper and the needle do not touch when lowering the needle bar. If the wiper is in a position where it will touch the needle, move the wiper to the right by hand so that it does not touch the needle.

2. Loosen the bolt (2).
3. Move the driver (4) to adjust so that the tip of the rotary hook is aligned with the middle of the needle and so that the driver needle guard (3) is touching the needle, and then tighten the bolt (2).

Note:

If the needle contact pressure is too great, skipped stitches may occur. On the other hand, if the driver needle guard (1) is not touching the needle, the tip of the inner rotary hook will obstruct the needle, resulting in an excessively high amount of friction.

9-4. Adjusting the needle clearance

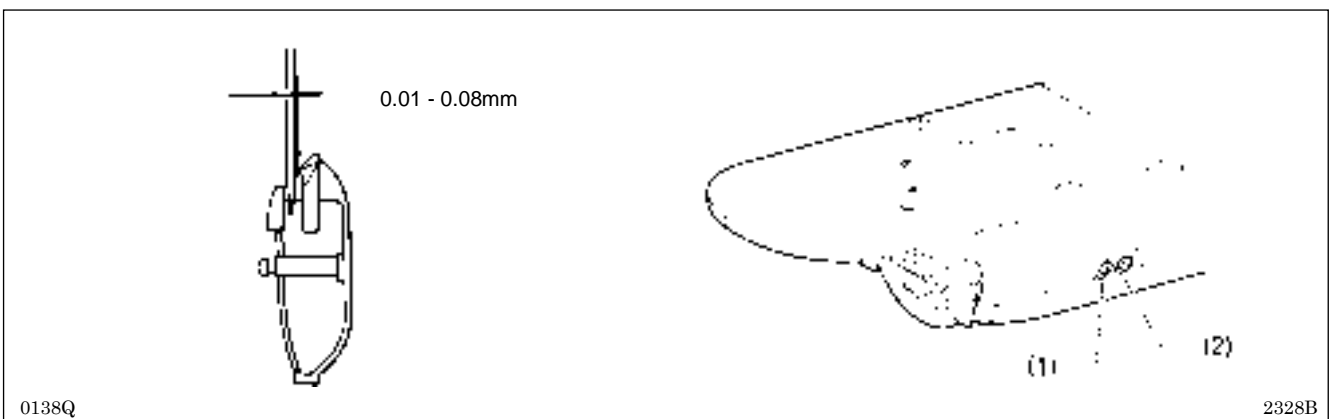

Turn the pulley to align the tip of the rotary hook with the needle center line. Then loosen the set screw (1) and turn the eccentric shaft (2) to adjust so that the clearance between the needle and the rotary hook is 0.01 - 0.08 mm.

9-5. Adjusting the shuttle race thread guide

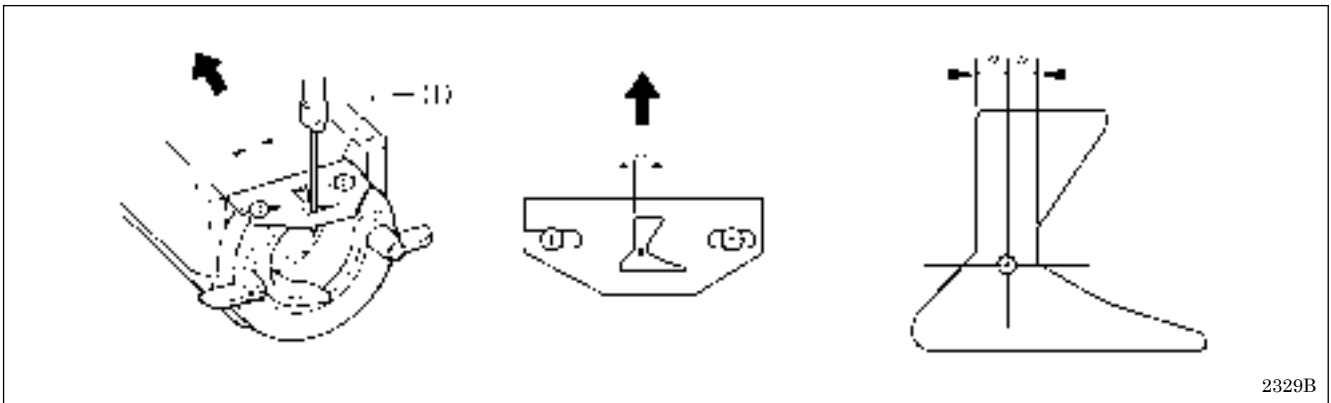

Install the shuttle race thread guide (1) by pushing it in the direction of the arrow so that the needle groove is aligned with the center of the needle plate hole.

Note:

If the shuttle race thread guide is in the wrong position, thread breakages, soiled thread or thread entanglements may occur.

The position of the shuttle race thread guide is adjusted at the time of shipment from the factory. It should not be changed if at all possible.

9-6. Rotary hook lubrication amount

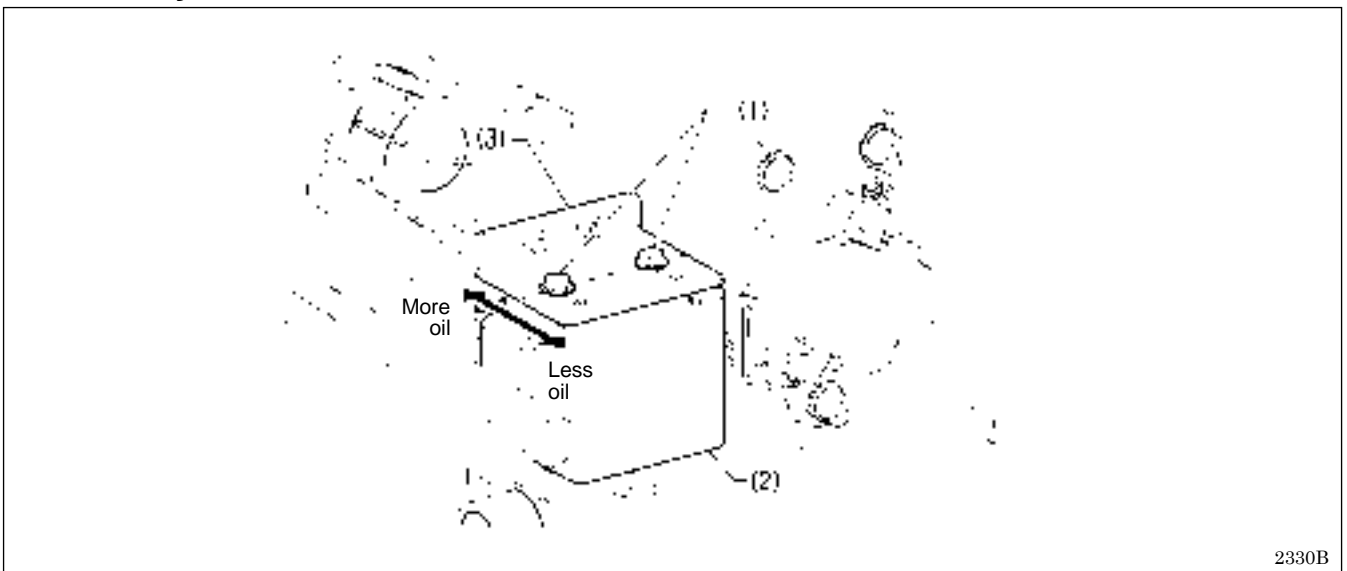

1. Tilt back the machine head.
2. Loosen the two bolts (1), and then adjust by moving the oil tank assembly (2) up or down.
* The standard position is when the centers of the two bolts (1) are aligned with the reference line on the oil tank plate (3).

9-7. Replacing the movable knife and fixed knife

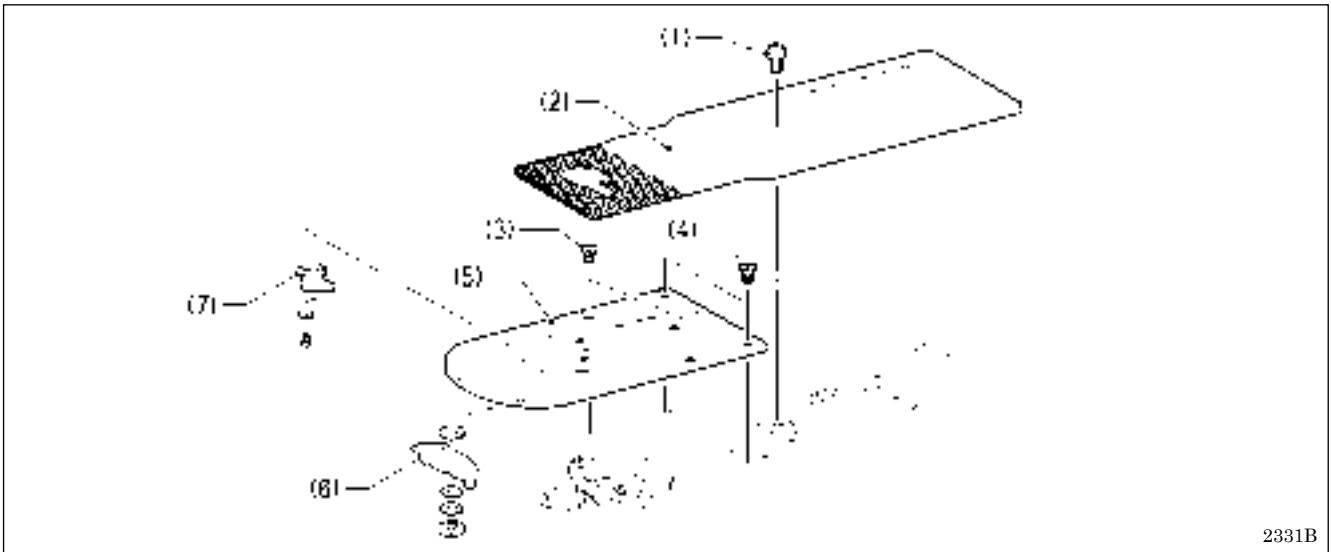

2331B

1. Open the shuttle race cover, remove the two screws (1), and then remove the feed plate (2).
2. Remove the two screws (3) and the two flat screws (4), and then remove the needle plate (5).
3. Remove the movable knife (6) and the fixed knife (7).

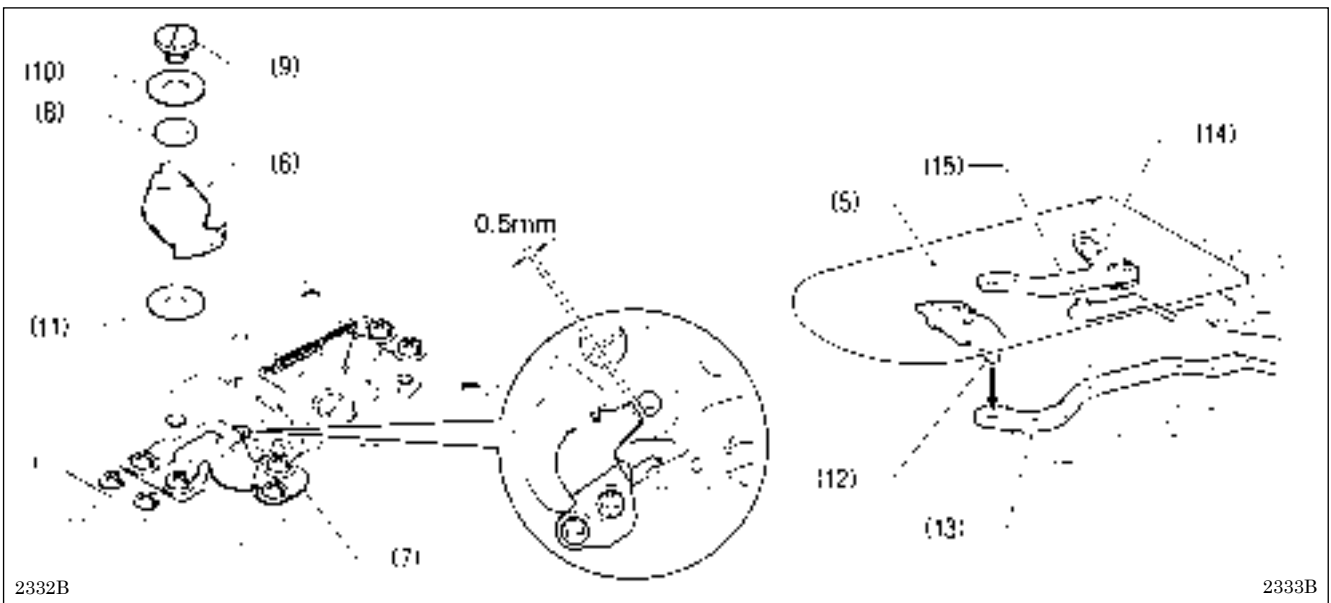

2332B

2333B

4. Install new fixed knife (7) in the position shown in the illustration.
5. Apply grease to the outside of the collar (8) and the shoulder screw (9), and then install the new movable knife (6) together with the thrust washer (10) and movable knife spacer (11).
6. Check that the movable knife (6) and the fixed knife (7) cut the thread cleanly.
7. Apply grease to the pin (12) of the movable knife, and then insert it into the hole in the movable knife connecting plate (13). Then, while placing the pin (15) of thread nipper connecting plate F into the hole in thread nipper D (14), install the needle plate (5).
8. Check that the center of the needle hole and the needle are aligned.

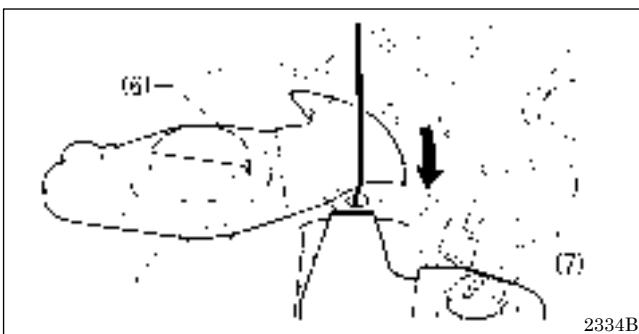

2334B

Select an accessory movable knife spacer (11) which allows the movable knife (6) to cross over the fixed knife (7) with a force that is as gentle as possible while still allowing the thread to be trimmed.

* Move the movable knife (6) as shown in the illustration and check that it trims the thread cleanly.

Note:

If the movable knife spacer (11) is too thick, it will not be possible to trim the thread.

9-8. Adjusting the work clamp lift amount (KE-430FX·FS)

Adjust so that the actual maximum lift amount for the work clamp is 17 mm above the top of the needle plate when the maximum work clamp height has been set to 17 mm using the operation panel.

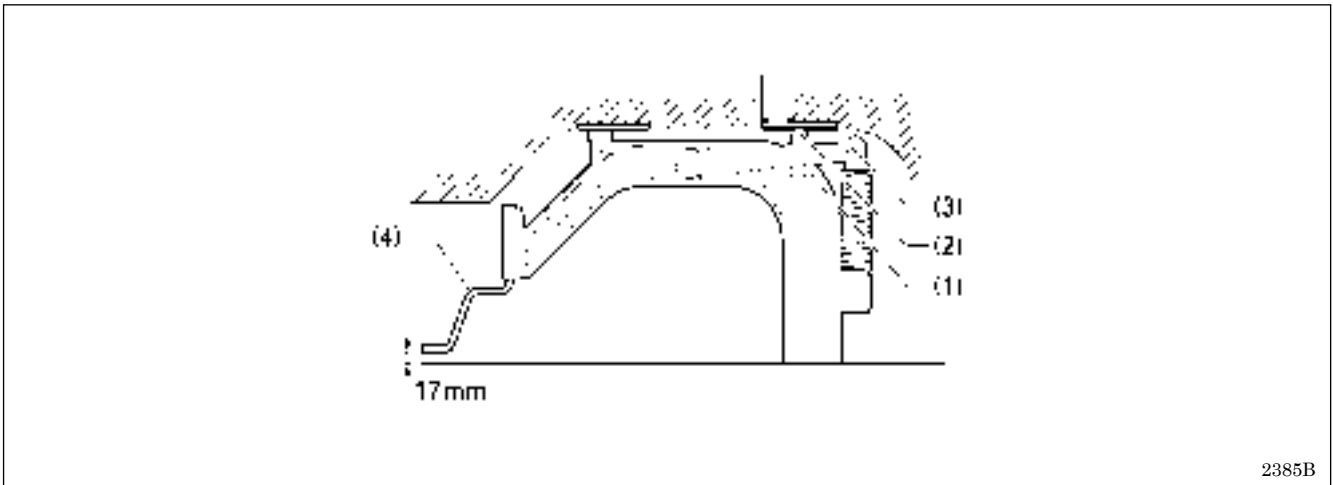

1. Loosen the bolt (1) and move the work clamp arm lever plate (2) up or down to adjust.
2. Apply grease to the bottom of the work clamp lifter plate (3), to the top of the work clamp arm lever plate (2) and to the sliding part of the work clamp (4) (grease is already applied at the time of shipment), and check that the movement becomes easier.

9-9. Adjusting the button clamp lift amount (BE-438FX)

Adjust so that the actual maximum lift amount for the button clamp is 13 mm above the top of the needle plate when the maximum button clamp height has been set to 13 mm using the operation panel.

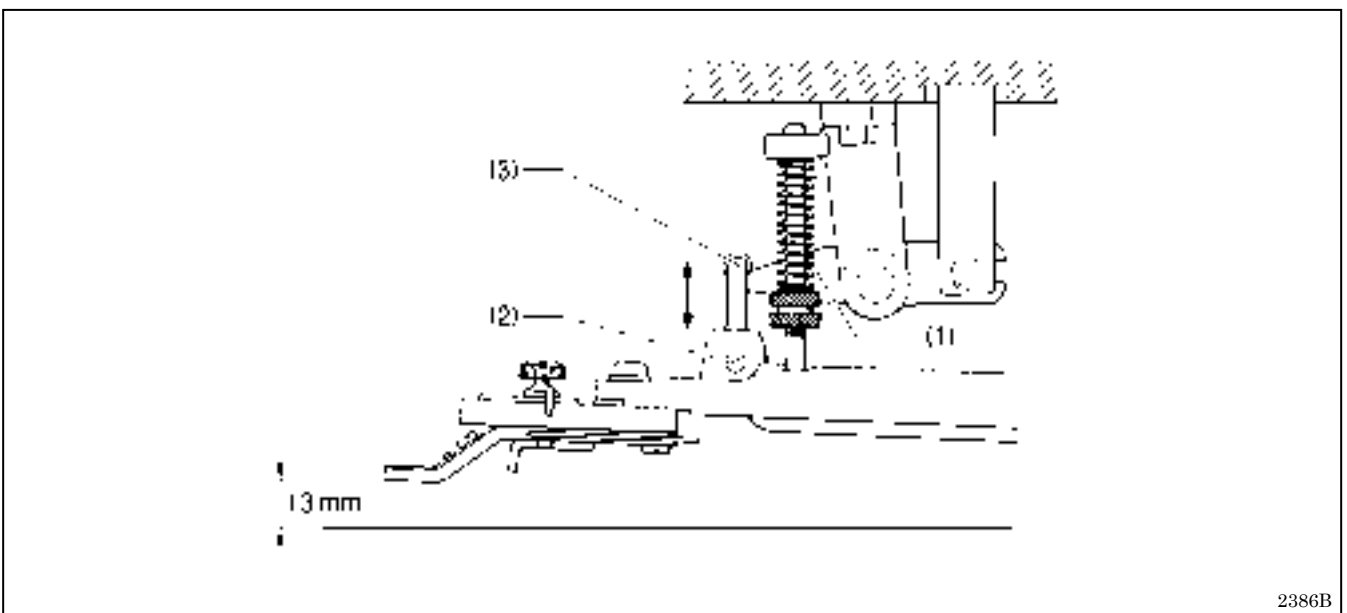

Remove the spring (1), loosen the screw (2) and adjust the button clamp holder hook (3) by moving it up and down.

* If the button clamp lift amount is too large, the button clamp will not be raised.

9-10. Adjusting the holding pressure (BE-438FX)

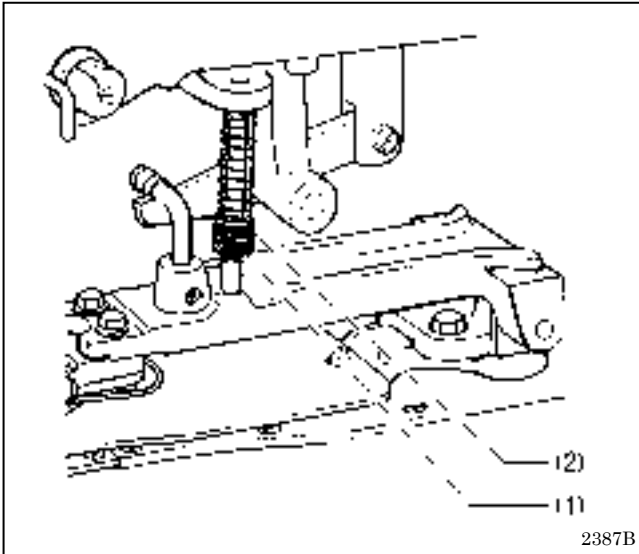

Loosen the nut (1) and turn the nut (2) to the point where it is just tight enough that the material will not slip out of place when it is slightly pulled (keep pressure as slight as possible).

9-11. Adjusting the position of the button clamp (BE-438FX)

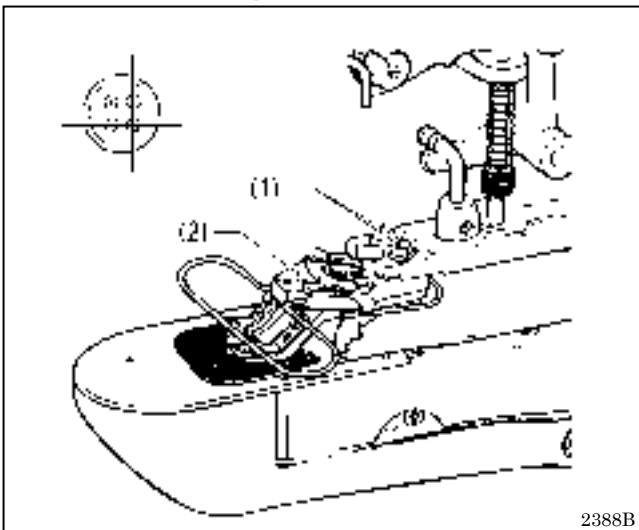

1. Loosen the two bolts (1) and adjust the button clamp base (2) by moving it.
2. Carry out test feeding to check that the needle will go through the button hole with no contact.

9-12. Adjusting the thread wiper

<Thread wiper height adjustment>

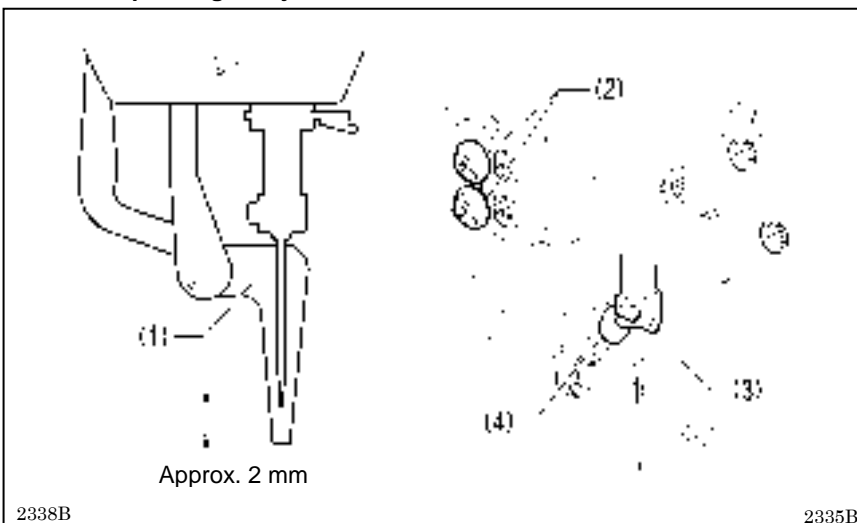

Loosen the two screws (2) and adjust the thread wiper (1) so that the clearance between the top of the thread wiper (1) and the needle point is approximately 2 mm when the thread wiper (1) is aligned with the center of the needle.

Note:

Check that the needle bar thread guide (3) and the thread wiper base shaft (4) are not touching at this time.

9. STANDARD ADJUSTMENT

< Thread wiper racking width adjustment >

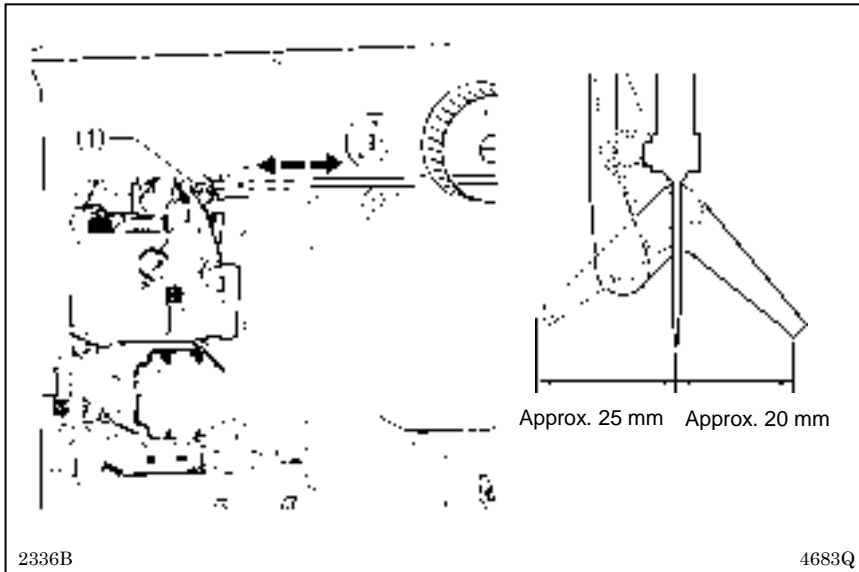

1. Remove the side cover.
2. Loosen the set screw (1) and adjust so that the distance from the thread wiper to the center of the needle is as shown in the illustration.

9-13. Checking the machine head switch

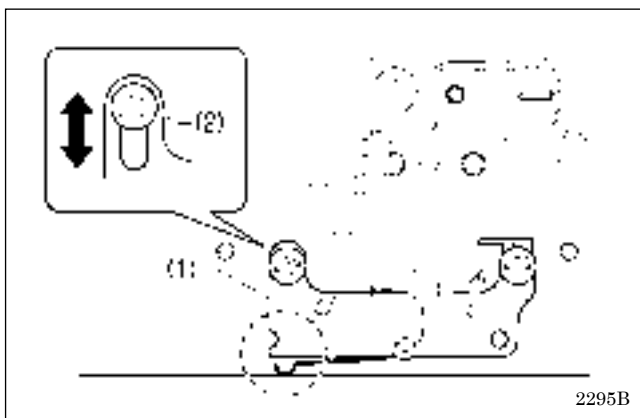

1. Turn on the power switch.
2. Check that no error numbers appear on the operation panel.

<If error [E050], [E051] or [E055] is displayed>

If the machine head switch (1) is not turned on, error [E050], [E051] or [E055] will occur.

Use the screw (2) to adjust the installation position of the machine head switch as shown in the illustration.

10. TABLE OF ERROR CODES



DANGER



Wait at least 5 minutes after turning off the power switch and disconnecting the power cord from the wall outlet before opening the face plate of the control box. Touching areas where high voltages are present can result in severe injury.

If a malfunction should occur with the sewing machine, a buzzer will sound and an error code will appear in the display window. Follow the remedy procedure to eliminate the cause of the problem.

Warnings displayed as symbols

Code	Cause and remedy
CLdn	The sewing machine started when the work clamp/button clamp was not lowered. First lower the work clamp/button clamp.
UP	The needle bar is not in the needle up stop position. Turn the pulley until this error display disappears.

Switch-related errors

Code	Cause and remedy
E010	The STOP switch was pressed. Press the RESET key to clear the error.
E011	The STOP switch was pressed. Press the RESET key to clear the error. You can press the ▼ key to move the work clamp so that you can continue sewing.
E012	The STOP switch was pressed. Press the RESET key to clear the error, and then depress the foot switch to the 2nd step to carry out home position detection.
E015	The STOP switch was still being pressed when the power was turned on, or there is a problem with the STOP switch connection. Turn off the power, and then check that connector P9 on the main P.C. board is properly connected.
E016	Problem with the STOP switch connection when the power was turned on. Turn off the power, and then check that connector P9 on the main P.C. board is properly connected.
E025	The foot switch was depressed to the 2nd step when the power was turned on. (Start switch for a two-pedal foot switch). Turn off the power and check the foot switch.
E035	The foot switch was depressed to the 1st step when the power was turned on. (Work clamp switch for a two-pedal foot switch). Turn off the power and check the foot switch.
E050	Machine head tilting was detected after the power was turned on. Turn off the power, and then return the machine head to its original position. Check that connector P14 on the main P.C. board is properly connected.
E051	Machine head tilting was detected while the sewing machine was operating. Turn off the power, and then check that connector P14 on the main P.C. board is properly connected.
E055	Machine head tilting was detected when the power was turned on. Turn off the power, and then return the machine head to its original position. Check that connector P14 on the main P.C. board is properly connected.
E065	An operation panel key was still being pressed when the power was turned on, or key is faulty. Turn off the power and check the operation panel.

10. TABLE OF ERROR CODES

Upper shaft motor-related errors

Code	Cause and remedy
E100	Sewing machine has continued to be used for a certain period after the "GREASEUP" notification appears without the grease being applied (without the reset procedure being carried out). Apply grease and then carry out the reset procedure. (Refer to the service manual for the reset procedure.)
E111	Upper shaft did not stop at the needle up stop position when the sewing machine stopped. Turn off the power, and then check that there are no problems with the thread trimming mechanism and the machine motor mechanism.
E121	Thread trimming was not completed. Turn off the power, and then check if the cutting edges of the fixed knife and movable knife are damaged or worn.
E130	Sewing machine motor stopped due to a problem, or synchronizer is faulty. Turn off the power, and then turn the machine pulley to check if the machine has locked up. Check that connector P11 on the power supply motor P.C. board and the 4-pin upper shaft motor connector are properly connected.
E131	Synchronizer is not connected correctly. Turn off the power, and then check that connector P11 on the power supply motor P.C. board is properly connected.
E132	Problem detected with sewing machine motor operation. Turn off the power, and then check that connector P11 on the motor P.C. board is properly connected.
E133	Sewing machine motor stopping position is incorrect. Turn off the power, and then check that connector P11 on the motor P.C. board is properly connected.
E150	Sewing machine motor is overheating, or temperature sensor is faulty. Turn off the power, and then check the sewing machine motor. (When sewing data with a small number of stitches (15 stitches or less) is sewn repeatedly (short cycle operation), the upper shaft motor may overheat and the "E150" error code may be generated.)

Feed mechanism-related errors

Code	Cause and remedy
E200	X feed motor home position cannot be detected. Problem with X feed motor or poor X encoder connection. Turn off the power, and then check that connectors P17 and P21 on the main P.C. board are properly connected.
E201	X feed motor stopped abnormally. Turn off the power and check that there is no problem with the X feed direction.
E204	X feed motor stopped abnormally during sewing. Turn off the power and check that there is no problem with the X feed direction.
E205	X-feed motor stopped due to a problem while moving to the sewing start position. Turn off the power and check that there is no problem with the X feed direction.
E206	X feed motor stopped abnormally during test feeding. Turn off the power and check that there is no problem with the X feed direction.
E210	Y feed motor home position cannot be detected. Problem with Y feed motor or poor Y encoder connection. Turn off the power, and then check that connectors P18 and P22 on the main P.C. board are properly connected.
E211	Y feed motor stopped abnormally. Turn off the power and check that there is no problem with the Y feed direction.
E214	Y feed motor stopped abnormally during sewing. Turn off the power and check that there is no problem with the Y feed direction.
E215	Y-feed motor stopped due to a problem while moving to the sewing start position. Turn off the power and check that there is no problem with the Y feed direction.
E216	Y feed motor stopped abnormally during test feeding. Turn off the power and check that there is no problem with the Y feed direction.

Work clamp-related errors

Code	Cause and remedy
E300	Work clamp home position cannot be detected. Problem with work clamp motor or poor work clamp encoder connection. Turn off the power, and then check that connectors P19 and P23 on the main P.C. board are properly connected.
E301	Work clamp/button clamp raised or lowered position cannot be detected. Turn off the power, and then check that there is no problem with the vertical work clamp/button clamp position.

Communication and memory-related errors

Code	Cause and remedy
E400	Communication error detected between the main P.C. board and the panel P.C. board when the power was turned on. Turn off the power, and then check that connector P1 on the panel P.C. board and connector P3 on the motor P.C. board are properly connected.
E401	Communication error detected between the main P.C. board and the motor P.C. board when the power was turned on. Turn off the power, and then check that connector P5 on the main P.C. board and connector P2 on the motor P.C. board are properly connected.
E410	Communication error between main P.C. board and panel P.C. board detected. Turn off the power, and then turn it back on again.
E411	Communication error between main P.C. board and motor P.C. board detected. Turn off the power, and then turn it back on again.
E420	No media is inserted. Press the RESET key to clear the error.
E421	Data contents are incorrect and cannot be used, or no data. Press the RESET key to clear the error. Check that data for this pattern number is present in the media.
E422	Error occurred while reading from media. Press the RESET key to clear the error. Check the data in the media.
E424	Insufficient space in media. Press the RESET key to clear the error. Use different media.
E425	Error occurred while reading from media. Press the RESET key to clear the error. Use the specified type of media. Check if the media is write-protected and if it has enough free space.
E427	A pattern registered in a cycle program has been erased. Press the RESET key to clear the error. Re-register the cycle program, or add the pattern.
E428	A pattern registered in a program has been erased. Press the RESET key to clear the error. Re-register the program, or add the pattern.
E430	Data cannot be backed up to main P.C. board. Turn off the power, and then turn it back on again.
E440	Data memory error on main P.C. board. Turn off the power, and then turn it back on again.
E450	Model selection has not been loaded from the machine head memory. Turn off the power and check that connector P16 on the power supply motor P.C. board is properly connected.
E451	Data cannot be backed up to machine head memory. Turn off the power, and then turn it back on again.
E452	Machine head memory is not connected. Turn off the power, and then check that connector P16 on the main P.C. board is properly connected.
E474	Internal memory is full and copying is not possible. Press the RESET key to clear the error. Clear any unnecessary additional patterns.

10. TABLE OF ERROR CODES

Data editing-related errors

Code	Cause and remedy
E500	The enlargement ratio setting caused the sewing data to extend outside the sewing area. Press the RESET key to clear the error. Set the enlargement ratio again.
E502	The enlargement ratio caused the data pitch to exceed the maximum pitch of 12.7 mm. Press the RESET key to clear the error. Set the enlargement ratio again.
E510	Error in pattern data. Press the RESET key to clear the error. Re-read the pattern data from the media, or recreate the pattern data.
E511	No end code has been input into pattern data. Press the RESET key to clear the error. Recreate the pattern data containing the end code, or change the pattern number being read.
E512	Number of stitches exceeds allowed maximum. Press the RESET key to clear the error. Change the number of the pattern being read.
E581	Memory switch file cannot be read correctly. Copy source model and copy destination model are incorrect. (Maybe the 430FX·FS is attempting to read data for the 438FX.) Press the RESET key to clear the error. Read data for the same sewing machine model.
E582	Memory switch versions do not match. Press the RESET key to clear the error. Read data for the same version.
E583	Parameter versions do not match. Press the RESET key to clear the error. Read data for the same version.

Device-related errors

Code	Cause and remedy
E690	Thread nipper motor home position cannot be detected. Problem with thread nipper motor or poor thread nipper encoder connection. Turn off the power, and then clean underneath the needle plate to remove any dust and thread scraps. Check that connector P20 on the main P.C. board is properly connected.
E691	Thread nipper retract position error. Check if the upper thread trailing length is too long. Turn off the power, and then clean underneath the needle plate to remove any dust and thread scraps. Check that connectors P20 and P4 on the main P.C. board are properly connected.

P.C. board-related errors

Code	Cause and remedy
E700	Abnormal rise in power supply voltage. Turn off the power and check the input voltage.
E701	Abnormal rise in sewing machine motor drive voltage. Turn off the power, and then check the voltage.
E705	Abnormal drop in power supply voltage. Turn off the power and check the input voltage.
E710	Abnormal current detected in sewing machine motor. Turn off the power, and then check if there are any problems with the sewing machine.
E711	Abnormal current detected in pulse motor. Turn off the power, and then check if there are any problems with the work clamp/button clamp operation.

If an error code that is not listed above appears or if carrying out the specified remedy does not solve the problem, contact the place of purchase.

11. TROUBLESHOOTING

- Please check the following points before calling for repairs or service.
- If the following remedies do not fix the problem, turn off the power switch and consult a qualified technician or the place of purchase.



CAUTION



Turn off the power switch and disconnect the power cord before carrying out troubleshooting, otherwise the machine may operate if the foot switch is depressed by mistake, which could result in injury.

Problem	Cause	Remedy	Ref.
Work clamp does not rise. (KE-430FX·FS)	Work clamp operation is sluggish.	Grease the sliding part of the work clamp.	P. 59
	Too much friction between work clamp lifter plate and work clamp arm lever plate.	Grease the work clamp lifter plate and work clamp arm lever plate.	
	Work clamp is contacting thread wiper.	Adjust the position of the thread wiper.	P. 70
Button clamp does not rise. (BE-438FX)	Work clamp is contacting thread wiper.	Adjust the position of the thread wiper.	P. 70
Work clamp lift amount is incorrect. (KE-430FX·FS)	Incorrect position of work clamp arm lever plate	Adjust the work clamp lift amount.	P. 69
Button clamp lift amount is incorrect. (BE-438FX)	Incorrect position of button clamp holder hook.	Adjust the button clamp lift amount.	P. 69
Thread wiper does not operate correctly.		Adjust the height of the thread wiper.	P. 70
	The thread wiper is obstructing the needle.	Adjust the operating distance of the thread wiper.	P. 71
	Thread wiper position is incorrect.	Adjust the operating distance of the thread wiper.	P. 71
Lower thread winds to one side.	Height of bobbin winder tension assembly is incorrect.	Adjust the height of the bobbin winder tension assembly.	P. 28
Lower thread winding amount is incorrect.	Bobbin presser position is incorrect.	Adjust the position of the bobbin presser.	P. 28
Thread comes unthreaded.	Stitches being skipped at the sewing start.	Refer to "Skipped stitches occur"	P. 77
	Uneven needle thread.	Adjust the sub-tension.	P. 30
	Needle thread is too short.	Use a thread nipper device.	P. 31

11. TROUBLESHOOTING

Problem	Cause	Remedy	Ref.
Upper thread breaks.	Upper thread tension is too strong.	Adjust the upper thread tension.	P. 63
	Needle is installed incorrectly.	Install the needle correctly.	P. 26
	Thread is too thick for the needle.	Use the correct thread for the needle.	P. 30
	Thread take-up spring tension and height are incorrect.	Adjust the tension and height of the thread take-up spring.	P. 64
	Damaged or burred rotary hook, needle hole plate or needle.	File smooth or replace the affected part.	
	Thread melting (synthetic thread)	Use the needle cooler.	P. 22
Lower thread breaks.	Lower thread tension is too strong.	Adjust the lower thread tension.	P. 63
	Corners of needle hole plate or bobbin case are damaged.	File smooth or replace the affected part.	
Skipped stitches occur.	Clearance between needle and rotary hook tip is too great.	Adjust the needle clearance.	P. 66
	Incorrect needle and rotary hook timing.	Adjust the needle bar lift amount.	P. 66
	Driver is contacting needle more than is necessary.	Adjust the driver needle guard.	P. 66
	Needle is bent.	Replace the needle.	
	Needle is installed incorrectly.	Install the needle correctly.	P. 26
Needle breaks.	Needle is touching the rotary hook.	Adjust the needle clearance.	P. 66
		Adjust the needle bar lift amount.	P. 66
	Needle is bent.	Replace the needle.	
	Needle is too thin.	Use the correct needle for the material.	P. 30
	Needle is striking the button. (BE-438FX)	Refer to "5-6. Checking the sewing pattern" .	P. 42
Button breaks. (BE-438FX)	Needle is striking the button.	Refer to "5-6. Checking the sewing pattern" .	P. 42

Problem	Cause	Remedy	Ref.
Upper thread is not trimmed.	Movable knife is blunt.	Replace the movable knife.	P. 68
	Fixed knife is blunt.	Sharpen or replace the fixed knife.	P. 68
	Movable knife does not pick up the thread.	Adjust the position of the shuttle race thread guide.	P. 67
		Adjust the needle bar lift amount.	P. 66
	The movable knife does not pick up the thread because of skipped stitches at the sewing end.	Refer to "Skipped stitches occur".	P. 77
	Movable knife position is incorrect.	Adjust the position of the movable knife.	P. 68
	Sub-tension is too weak.	Turn the sub-tension nut to adjust the tension.	P. 30
Thread jamming.	Thread take-up spring tension and height are incorrect.	Adjust the tension and height of the thread take-up spring.	P. 64
	Incorrect needle and rotary hook timing.	Adjust the needle bar lift amount.	P. 66
	Shuttle race thread guide is not separating the threads.	Adjust the position of the shuttle race thread guide.	P. 67
Poor seam finish on reverse side of material.	Shuttle race thread guide is separating the threads insufficiently.	Adjust the position of the shuttle race thread guide.	P. 67
	Upper thread is not properly tight.	Adjust the upper thread tension.	P. 63
	Uneven needle thread.	Adjust the sub-tension.	P. 30
	Needle thread is too long.	Adjust the sub-tension. <When using the thread nipper device> Turn the tension nut to adjust the upper thread trailing length to 35 – 38 mm.	P. 30
	Needle is striking the button. (BE-438FX)	Refer to "5-5. Checking the sewing pattern".	P. 42
Incorrect thread tightness.	Upper thread tension is too weak.	Adjust the upper thread tension.	P. 63
	Lower thread tension is too weak.	Adjust the lower thread tension.	P. 63
	Thread take-up spring tension and height are incorrect.	Adjust the tension and height of the thread take-up spring.	P. 64
Machine does not operate when power is turned on and foot switch is depressed.	Machine head switch does not work.	Check if the machine head switch cord is disconnected.	P. 17
		Adjust the position of the switching plate.	P. 25
		Replace the machine head switch if it is broken.	

12. 7-SEGMENT DISPLAY LIST

0	1	2	3	4	5	6	7	8	9
A	B	C	D	E	F	G	H	I	J
K	L	M	N	O	P	Q	R	S	T
U	V	W	X	Y	Z				

4268M

brother

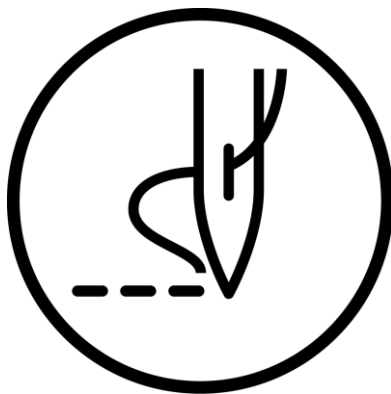

INSTRUCTION MANUAL

* Please note that the contents of this manual may differ slightly from the actual product purchased as a result of product improvements.

BROTHER INDUSTRIES, LTD. <http://www.brother.com/>
1-5, Kitajizoyama, Noda-cho, Kariya 440-0003, Japan Phone 01-500-95-0000

© 2013 Brother Industries, Ltd. All Rights Reserved.
This is the original instructions.

KE-430FX/KE-430FS, BE-438FX
SB4760-001 E
2013.08.B(1)