

Operation Manual

Embroidery and Sewing Machine

Product Code: 888-G00/G02/G04/G05

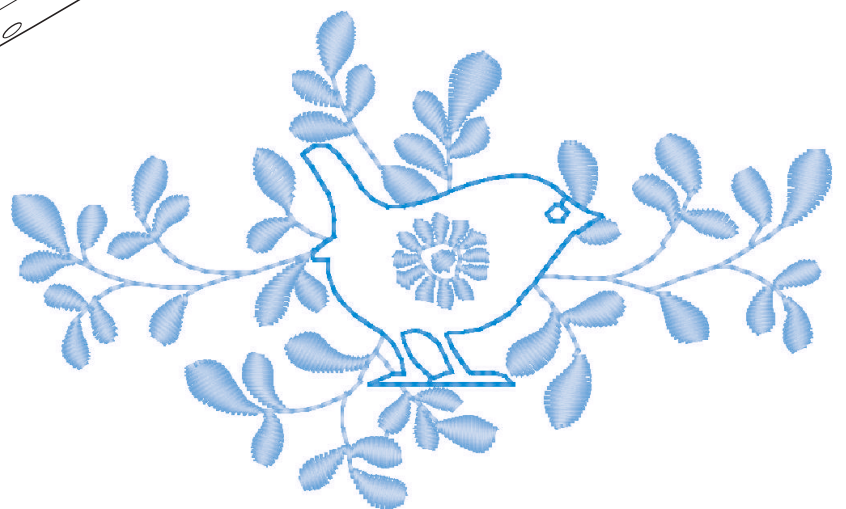
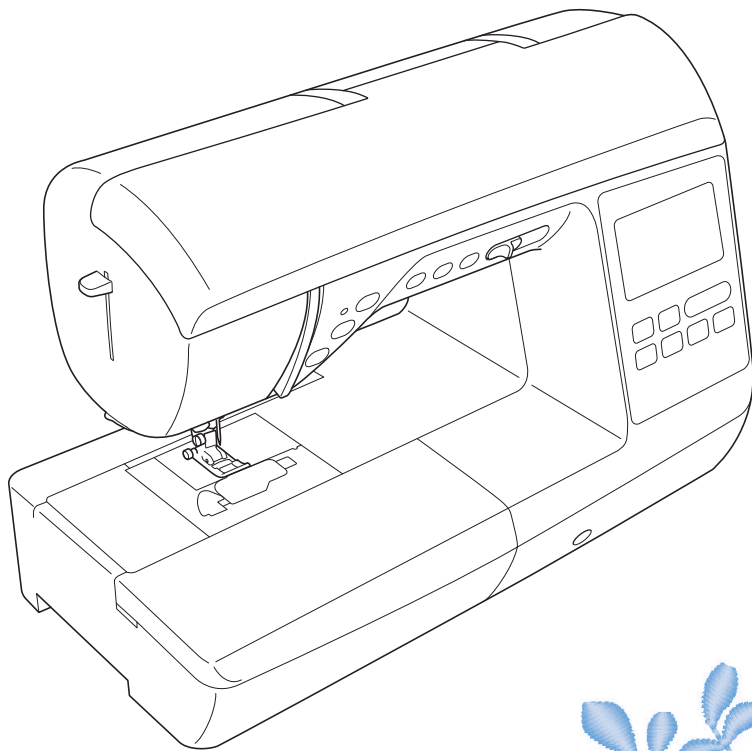

Be sure to read this document before using the machine.
We recommend that you keep this document nearby for future reference.

INTRODUCTION

Thank you for purchasing this machine. Before using this machine, carefully read the “IMPORTANT SAFETY INSTRUCTIONS”, and then study this manual for the correct operation of the various functions. In addition, after you have finished reading this manual, store it where it can quickly be accessed for future reference.

IMPORTANT SAFETY INSTRUCTIONS

Please read these safety instructions before attempting to use the machine.

DANGER - To reduce the risk of electrical shock

- 1** Always unplug the machine from the electrical outlet immediately after using, when cleaning, making any user servicing adjustments mentioned in this manual, or if you are leaving the machine unattended.

WARNING - To reduce the risk of burns, fire, electrical shock, or injury to persons.

- 2** Always unplug the machine from the electrical outlet when making any adjustments mentioned in the instruction manual.

- To unplug the machine, switch the machine to the symbol “O” position to turn it off, then grasp the plug and pull it out of the electrical outlet. Do not pull on the cord.
- Plug the machine directly into the electrical outlet. Do not use an extension cord.
- Always unplug your machine if there is a power failure.

- 3** Electrical Hazards:

- This machine should be connected to an AC power source within the range indicated on the rating label. Do not connect it to a DC power source or converter. If you are not sure what kind of power source you have, contact a qualified electrician.
- This machine is approved for use in the country of purchase only.

- 4** Never operate this machine if it has a damaged cord or plug, if it is not working properly, has been dropped or damaged, or water is spilled on the unit. Return the machine to the nearest authorized Brother dealer for examination, repair, electrical or mechanical adjustment.

- While the machine is stored or in use if you notice anything unusual, such as an odor, heat, discoloration or deformation, stop using the machine immediately and unplug the power cord.
- When transporting the machine, be sure to carry it by its handle. Lifting the machine by any other part may damage the machine or result in the machine falling, which could cause injuries.
- When lifting the machine, be careful not to make any sudden or careless movements, which may cause a personal injury.

5 Always keep your work area clear:

- Never operate the machine with any air openings blocked. Keep ventilation openings of the machine and foot control free from the build up of lint, dust, and loose cloth.
- Do not store objects on the foot controller.
- Do not use extension cords. Plug the machine directly into the electrical outlet.
- Never drop or insert foreign objects in any opening.
- Do not operate where aerosol (spray) products are being used or where oxygen is being administered.
- Do not use the machine near a heat source, such as a stove or iron; otherwise, the machine, power cord or garment being sewn may ignite, resulting in fire or an electric shock.
- Do not place this machine on an unstable surface, such as an unsteady or slanted table, otherwise the machine may fall, resulting in injuries.

6 Special care is required when sewing:

- Always pay close attention to the needle. Do not use bent or damaged needles.
- Keep fingers away from all moving parts. Special care is required around the machine needle.
- Switch the machine to the symbol "O" position to turn it off when making any adjustments in the needle area.
- Do not use a damaged or incorrect needle plate, as it could cause the needle to break.
- Do not push or pull the fabric when sewing, and follow careful instruction when free motion stitching so that you do not deflect the needle and cause it to break.

7 This machine is not a toy:

- Your close attention is necessary when the machine is used by or near children.
- The plastic bag that this machine was supplied in should be kept out of the reach of children or disposed of. Never allow children to play with the bag due to the danger of suffocation.
- Do not use outdoors.

8 For a longer service life:

- When storing this machine, avoid direct sunlight and high humidity locations. Do not use or store the machine near a space heater, iron, halogen lamp, or other hot objects.
- Use only neutral soaps or detergents to clean the case. Benzene, thinner, and scouring powders can damage the case and machine, and should never be used.
- Always consult the Operation Manual when replacing or installing any assemblies, the presser feet, needle or other parts to assure correct installation.

9 For repair or adjustment:

- If the light unit is damaged, it must be replaced by an authorized Brother dealer.
- In the event a malfunction occurs or adjustment is required, first follow the troubleshooting table in the back of the Operation Manual to inspect and adjust the machine yourself. If the problem persists, please consult your local authorized Brother dealer.

Use this machine only for its intended use as described in the manual.

Use accessories recommended by the manufacturer as contained in this manual.

The contents of this manual and specifications of this product are subject to change without notice.

For additional product information and updates, visit our website at www.brother.com

SAVE THESE INSTRUCTIONS

This machine is intended for household use.

FOR USERS IN COUNTRIES EXCEPT EUROPEAN COUNTRIES

This appliance is not intended for use by persons (including children) with reduced physical, sensory or mental capabilities, or lack of experience and knowledge, unless they have been given supervision or instruction concerning use of the appliance by a person responsible for their safety. Children should be supervised to ensure that they do not play with the appliance.

FOR USERS IN EUROPEAN COUNTRIES

This appliance can be used by children aged from 8 years and above and persons with reduced physical, sensory or mental capabilities or lack of experience and knowledge if they have been given supervision or instruction concerning use of the appliance in a safe way and understand the hazards involved. Children shall not play with the appliance. Cleaning and user maintenance shall not be made by children without supervision.

FOR USERS IN THE UK, EIRE, MALTA AND CYPRUS ONLY

IMPORTANT

- In the event of replacing the plug fuse, use a fuse approved by ASTA to BS 1362, i.e. carrying the  mark, rating as marked on plug.
- Always replace the fuse cover. Never use plugs with the fuse cover omitted.
- If the available electrical outlet is not suitable for the plug supplied with this equipment, you should contact your authorized Brother dealer to obtain the correct lead.

TRADEMARKS

IMPORTANT:

READ BEFORE DOWNLOADING, COPYING, INSTALLING OR USING.

By downloading, copying, installing or using the software you agree to this license. If you do not agree to this license, do not download, install, copy or use the software.

Intel License Agreement For Open Source Computer Vision Library

Copyright © 2000, Intel Corporation, all rights reserved. Third party copyrights are property of their respective owners.

Redistribution and use in source and binary forms, with or without modification, are permitted provided that the following conditions are met:

- Redistribution's of source code must retain the above copyright notice, this list of conditions and the following disclaimer.
- Redistribution's in binary form must reproduce the above copyright notice, this list of conditions and the following disclaimer in the documentation and/or other materials provided with the distribution.
- The name of Intel Corporation may not be used to endorse or promote products derived from this software without specific prior written permission.

This software is provided by the copyright holders and contributors "as is" and any express or implied warranties, including, but not limited to, the implied warranties of merchantability and fitness for a particular purpose are disclaimed. In no event shall Intel or contributors be liable for any direct, indirect, incidental, special, exemplary, or consequential damages (including, but not limited to, procurement of substitute goods or services; loss of use, data, or profits; or business interruption) however caused and on any theory of liability, whether in contract, strict liability, or tort (including negligence or otherwise) arising in any way out of the use of this software, even if advised of the possibility of such damage.

All information provided related to future Intel products and plans is preliminary and subject to change at any time, without notice.

WHAT YOU CAN DO WITH THIS MACHINE

B Basic operations

After purchasing your machine, be sure to read this section first. This section provides details on the initial setup procedures as well as descriptions of this machine's more useful functions.

Chapter 1 GETTING READY *Page B-2*

To learn the operation of the principal parts and the screens

Chapter 2 STARTING TO SEW *Page B-35*

To learn how to prepare for sewing and basic sewing operations

Chapter 3 STARTING TO EMBROIDER *Page B-52*

To learn how to prepare for embroidering and basic embroidering operations

S Sewing

This section describes procedures for using the various utility stitches as well as other functions. It provides details on basic machine sewing in addition to the more expressive features of the machine, such as sewing tubular pieces and buttonholes.

Chapter 1 SEWING ATTRACTIVE FINISHES *Page S-2*

Tips for sewing attractive finishes and various fabrics

Chapter 2 UTILITY STITCHES *Page S-6*

Sew pre-programmed frequently used stitches

D Decorative sewing

This section provides instructions on sewing character stitches and decorative stitches as well as on adjusting and editing them. In addition, it describes how to use MY CUSTOM STITCH, which allows you to create original stitch patterns.

Chapter 1 CHARACTER / DECORATIVE STITCHES *Page D-2*

The variety of stitches widen your creativity

Chapter 2 MY CUSTOM STITCH *Page D-19*

Create original decorative stitches

E Embroidering

This section provides instruction on editing embroidery patterns and recalling stored embroidery patterns.

Chapter 1 EMBROIDERY *Page E-2*

Embroider artistically; by editing the built-in patterns you can easily create your own original designs.

A Appendix

This section provides important information for operating this machine.

Chapter 1 MAINTENANCE AND TROUBLESHOOTING *Page A-2*

The various maintenance and troubleshooting procedures are described.

CONTENTS

| | |
|--|----|
| INTRODUCTION | i |
| IMPORTANT SAFETY INSTRUCTIONS | i |
| TRADEMARKS | iv |
| WHAT YOU CAN DO WITH THIS MACHINE..... | v |

B Basic operations

Chapter 1 GETTING READY 2

| | |
|--|-----------|
| Names of Machine Parts and Their Functions..... | 2 |
| Machine..... | 2 |
| Needle and presser foot section | 3 |
| Embroidery Unit..... | 3 |
| Operation buttons | 4 |
| Operation panel and operation keys..... | 4 |
| Using the flat bed attachment..... | 5 |
| Included accessories | 6 |
| Optional accessories | 7 |
| Using the utility stitch tables in the "Sewing" section | 8 |
| Turning the Machine On/Off..... | 9 |
| Turning on the machine | 10 |
| Turning off the machine | 10 |
| Select machine setting for the first time | 10 |
| LCD Operation | 11 |
| Viewing the LCD..... | 11 |
| Using the settings key..... | 13 |
| Adjusting input sensitivity for operation keys..... | 16 |
| Saving a settings screen image to USB flash drive..... | 17 |
| Checking machine operating procedures..... | 17 |
| Winding/Installing the Bobbin..... | 18 |
| Winding the bobbin | 18 |
| Installing the bobbin..... | 21 |
| Upper Threading | 24 |
| Threading the upper thread | 24 |
| Threading the needle..... | 26 |
| Threading the needle manually (without using the needle threader)..... | 27 |
| Pulling up the bobbin thread | 27 |
| Using the twin needle | 28 |
| Replacing the Needle..... | 30 |
| Fabric/thread/needle combinations..... | 30 |
| Checking the needle..... | 31 |
| Replacing the needle..... | 31 |
| Replacing the Presser Foot..... | 33 |
| Replacing the presser foot | 33 |
| Removing and attaching the presser foot holder | 34 |

Chapter 2 STARTING TO SEW 35

| | |
|---|-----------|
| Sewing..... | 35 |
| Stitch types | 35 |
| Sewing a stitch | 35 |
| Sewing reinforcement stitches | 38 |
| Automatic reinforcement stitching..... | 38 |
| Setting the Stitch | 40 |
| Setting the stitch width | 40 |
| Setting the stitch length | 40 |
| Setting the "L/R Shift" | 41 |
| Setting the thread tension | 41 |
| Saving stitch settings..... | 42 |
| Useful Functions..... | 43 |
| Automatically cutting the thread..... | 43 |
| Mirroring stitches | 43 |
| Adjusting the presser foot pressure | 43 |
| Automatic Fabric Sensor System (Automatic presser foot pressure)..... | 44 |

| | |
|--|-----------|
| Pivoting | 44 |
| Sewing with free motion mode | 45 |
| Hands-free raising and lifting of the presser foot | 46 |
| Stitch Setting Chart..... | 47 |

Chapter 3 STARTING TO EMBROIDER 52

| | |
|---|-----------|
| Embroidery Step by Step..... | 52 |
| Attaching the Embroidery Foot | 53 |
| Attaching the Embroidery Unit | 54 |
| Embroidery Attractive Finishes | 56 |
| Preparing the Fabric..... | 57 |
| Attaching iron-on stabilizers (backing) to the fabric | 57 |
| Hooping the fabric in the embroidery frame | 58 |
| Embroidering small fabrics or fabric edges..... | 60 |
| Attaching the Embroidery Frame | 61 |
| Selecting Embroidery Patterns | 62 |
| Copyright information..... | 62 |
| Embroidery pattern types | 62 |
| Selecting an embroidery pattern | 62 |
| Confirming the Pattern Position..... | 63 |
| Checking the pattern position | 63 |
| Previewing the selected pattern | 63 |
| Embroidering | 64 |
| Embroidering a pattern | 64 |
| Changing the thread color display | 65 |

S Sewing

Chapter 1 SEWING ATTRACTIVE FINISHES 2

| | |
|---|----------|
| Sewing Tips..... | 2 |
| Trial sewing | 2 |
| Changing the sewing direction | 2 |
| Sewing curves..... | 2 |
| Sewing cylindrical pieces | 2 |
| Sewing an even seam allowance | 3 |
| Sewing Various Fabrics | 4 |
| Sewing thick fabrics..... | 4 |
| Sewing thin fabrics | 4 |
| Sewing stretch fabrics | 5 |
| Sewing leathers or vinyl fabrics..... | 5 |
| Sewing hook-and-loop fastener tape..... | 5 |

Chapter 2 UTILITY STITCHES 6

| | |
|---|-----------|
| Basic Stitching..... | 6 |
| Basting..... | 6 |
| Basic stitching..... | 6 |
| Blind Hem Stitching | 8 |
| Overcasting Stitches | 11 |
| Sewing overcasting stitches using overcasting foot "G" | 11 |
| Sewing overcasting stitches using zigzag foot "J" | 12 |
| Sewing overcasting stitches using the side cutter (sold separately with some models)..... | 12 |
| Buttonhole Stitching/Button Sewing | 14 |
| Buttonhole sewing..... | 14 |
| Button sewing..... | 17 |
| Zipper Insertion | 19 |
| Inserting a centered zipper..... | 19 |
| Inserting a side zipper..... | 20 |
| Zipper/piping Insertion | 23 |
| Inserting a centered zipper..... | 23 |
| Inserting a piping | 24 |

| | |
|--|-----------|
| Sewing Stretch Fabrics and Elastic Tape | 25 |
| Stretch stitching | 25 |
| Elastic attaching | 25 |
| Appliqué, Patchwork and Quilt Stitching | 26 |
| Appliqué stitching | 26 |
| Patchwork (crazy quilt) stitching | 27 |
| Piecing | 27 |
| Quilting | 29 |
| Free motion quilting | 30 |
| Satin stitching using the sewing speed controller | 34 |
| Reinforcement Stitching | 35 |
| Triple stretch stitching | 35 |
| Bar tack stitching | 35 |
| Darning | 36 |
| Eyelet Stitching | 38 |
| Attaching Patches or Emblems to Shirt Sleeves | 39 |
| Decorative Stitching | 41 |
| Fagoting | 41 |
| Scallop stitching | 42 |
| Smocking | 42 |
| Shell tuck stitching | 43 |
| Joining | 43 |
| Heirloom stitching | 44 |

D Decorative sewing

Chapter 1 CHARACTER / DECORATIVE STITCHES 2

| | |
|--|-----------|
| Selecting Stitch Patterns | 2 |
| Selecting decorative stitch patterns/satin stitch patterns/ 7 mm satin stitch patterns/cross stitch/utility decorative stitch patterns | 2 |
| Characters | 2 |
| Sewing Stitch Patterns | 4 |
| Sewing attractive finishes | 4 |
| Basic sewing | 4 |
| Making adjustments | 5 |
| Editing Stitch Patterns | 7 |
| Changing the size | 9 |
| Changing the length (for 7 mm satin stitch patterns only) | 9 |
| Creating a horizontal mirror image | 9 |
| Sewing a pattern continuously | 9 |
| Changing thread density (for satin stitch patterns only) | 10 |
| Returning to the beginning of the pattern | 10 |
| Checking the image | 11 |
| Combining Stitch Patterns | 12 |
| Before combining | 12 |
| Combining various stitch patterns | 12 |
| Combining large and small stitch patterns | 12 |
| Combining horizontal mirror image stitch patterns | 13 |
| Combining stitch patterns of different length | 13 |
| Making step stitch patterns | 14 |
| Using The Memory Function | 15 |
| Stitch data precautions | 15 |
| Saving stitch patterns in the machine's memory | 15 |
| Saving stitch patterns to USB flash drive | 16 |
| Retrieving stitch patterns from the machine's memory | 17 |
| Recalling from USB flash drive | 17 |

Chapter 2 MY CUSTOM STITCH 19

| | |
|--|-----------|
| Designing a Stitch | 19 |
| Entering Stitch Data | 21 |
| Editing a built-in sample pattern | 23 |
| Using Stored Custom Stitches | 24 |
| Storing custom stitches in your list | 24 |
| Retrieving stored stitches | 24 |

E Embroidering

Chapter 1 EMBROIDERY 2

| | |
|--|-----------|
| Selecting Patterns | 2 |
| Selecting embroidery patterns/Brother "Exclusives"/floral alphabet patterns | 2 |
| Selecting character patterns | 2 |
| Selecting frame patterns | 4 |
| Editing Patterns | 5 |
| Moving the pattern | 6 |
| Changing the size of the pattern | 6 |
| Rotating the pattern | 6 |
| Changing the thread color | 7 |
| Creating a horizontal mirror image | 7 |
| Changing the density (alphabet character and frame patterns only) | 7 |
| Deleting the pattern | 7 |
| Displaying patterns in the screen magnification | 8 |
| After editing | 8 |
| Editing Character Patterns | 9 |
| Changing the colors of alphabet character patterns | 9 |
| Switching between text written vertically and horizontally | 9 |
| Changing the font of entered characters | 10 |
| Changing character spacing | 10 |
| Reducing character spacing | 10 |
| Separating combined character patterns | 10 |
| Editing single characters | 11 |
| Changing the configuration of character patterns | 12 |
| Combining Patterns | 13 |
| Editing combined patterns | 13 |
| Embroidering combined patterns | 14 |
| Editing All Patterns | 15 |
| Moving the pattern | 15 |
| Rotating the pattern | 15 |
| Aligning the pattern and the needle | 15 |
| Embroidering linked characters | 16 |
| Embroidery Applications | 18 |
| Sewing embroidery patterns which use appliqué | 18 |
| Using a frame pattern to make an appliqué (1) | 20 |
| Using a frame pattern to make an appliqué (2) | 21 |
| Sewing split embroidery patterns | 22 |
| Adjustments During the Embroidery Process | 23 |
| If the bobbin runs out of thread | 23 |
| If the thread breaks during sewing | 24 |
| Restarting from the beginning | 24 |
| Resuming embroidery after turning off the power | 24 |
| Making Embroidery Adjustments | 26 |
| Adjusting thread tension | 26 |
| Adjusting the bobbin case (with no color on the screw) | 27 |
| Using the automatic thread cutting function (END COLOR TRIM) | 28 |
| Adjusting the embroidery speed | 28 |
| Changing the "Embroidery Frame Display" | 28 |
| Selecting/displaying patterns according to the embroidery frame size | 29 |
| Changing the background colors of the embroidery patterns | 30 |
| Specifying the size of pattern thumbnails | 30 |
| Using the Memory Function | 31 |
| Embroidery data precautions | 31 |
| Saving embroidery patterns in the machine's memory | 32 |
| Saving embroidery patterns to USB flash drive | 33 |
| Retrieving patterns from the machine's memory | 33 |
| Recalling from USB flash drive | 34 |

A Appendix

Chapter 1 MAINTENANCE AND TROUBLESHOOTING 2

Care and Maintenance..... 2

- Restrictions on oiling..... 2
- Precautions on storing the machine..... 2
- Cleaning the LCD Screen 2
- Cleaning the machine surface 2
- Cleaning the race 2
- About the maintenance message 4
- Touch panel is malfunctioning 4
- Operation beep..... 4

Troubleshooting..... 5

- Frequent troubleshooting topics 5
- Upper thread tightened up 5
- Tangled thread on wrong side of fabric 6
- Incorrect thread tension..... 7
- Fabric is caught in the machine and cannot be removed 8
- When the thread became tangled under the bobbin winder seat 11
- List of symptoms..... 13
- Error messages..... 19

Specifications 21

Upgrading your machine’s software using USB flash drive..... 22

Index 23

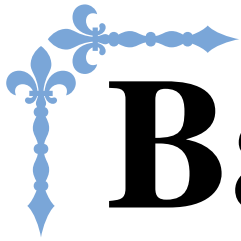

Basic operations

This section provides details on the initial setup procedures as well as descriptions of this machine's more useful functions.

Page number starts with "B" in this section.

| | |
|--|-------------|
| Chapter1 GETTING READY..... | B-2 |
| Chapter2 STARTING TO SEW..... | B-35 |
| Chapter3 STARTING TO EMBROIDER..... | B-52 |

Chapter 1 GETTING READY

Names of Machine Parts and Their Functions

The names of the various parts of the machine and their functions are described below. Before using the machine, carefully read these descriptions to learn the names of the machine and their locations.

Machine

■ Front view

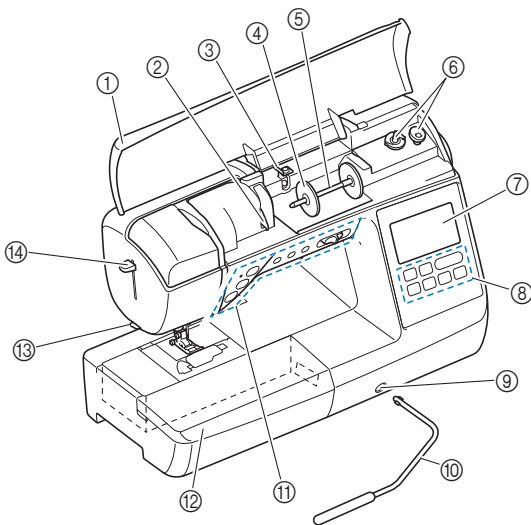

- ① **Top cover**
Open the top cover to place the spool of thread on the spool pin.
- ② **Thread guide plate**
Pass the thread around the thread guide plate when threading the upper thread.
- ③ **Bobbin winding thread guide and pretension disk**
Pass the thread under this thread guide and around the pretension disk when winding the bobbin thread.
- ④ **Spool cap**
Use the spool cap to hold the spool of thread in place.
- ⑤ **Spool pin**
Place a spool of thread on the spool pin.
- ⑥ **Bobbin winder**
Use the bobbin winder when winding the bobbin.
- ⑦ **LCD (liquid crystal display)**
Settings for the selected stitch and error messages appear in the LCD. (page B-11)
- ⑧ **Operation panel**
From the operation panel, stitch settings can be selected and edited, and operations for using the machine can be selected (page B-4).
- ⑨ **Knee lifter mounting slot**
Insert the knee lifter into the knee lifter mounting slot.
- ⑩ **Knee lifter**
Use the knee lifter to raise and lower the presser foot. (page B-46)
- ⑪ **Operation buttons and sewing speed controller**
Use these buttons and the slide to operate the machine. (page B-4)

⑫ **Flat bed attachment**

Insert the presser foot accessory tray into the accessory compartment of the flat bed attachment. Remove the flat bed attachment when sewing cylindrical pieces such as sleeve cuffs.

⑬ **Thread cutter**

Pass the threads through the thread cutter to cut them.

⑭ **Needle threader lever**

Use the needle threader lever to thread the needle.

■ Right-side/rear view

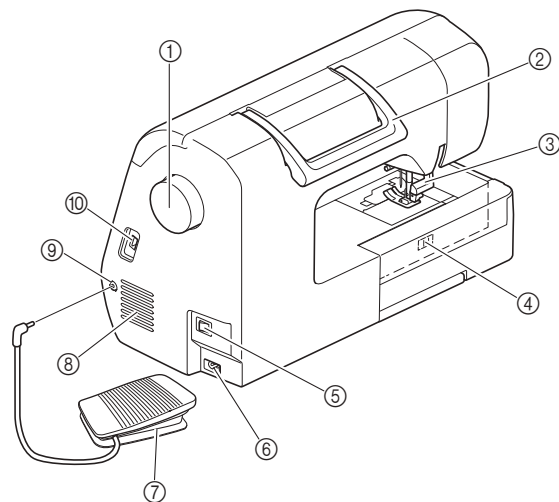

① **Handwheel**

Turn the handwheel toward you (counterclockwise) to raise and lower the needle to sew one stitch.

② **Handle**

Carry the machine by its handle when transporting.

③ **Presser foot lever**

Raise and lower the presser foot lever to raise and lower the presser foot.

④ **Feed dog position switch**

Use the feed dog position switch to lower the feed dogs.

⑤ **Main power switch**

Use the main power switch to turn the machine on and off.

⑥ **Power supply jack**

Insert the plug on the power cord into the power supply jack.

⑦ **Foot controller**

Depress the foot controller to control the speed of the machine. (page B-37)

⑧ **Air vent**

The air vent allows the air surrounding the motor to circulate. Do not cover the air vent while the machine is being used.

- ⑨ **Foot controller jack**
Insert the plug on the end of the foot controller cable into the foot controller jack.
- ⑩ **USB port (for a USB flash drive)**
In order to import patterns from a USB flash drive, insert the USB flash drive directly into the USB port.

Needle and presser foot section

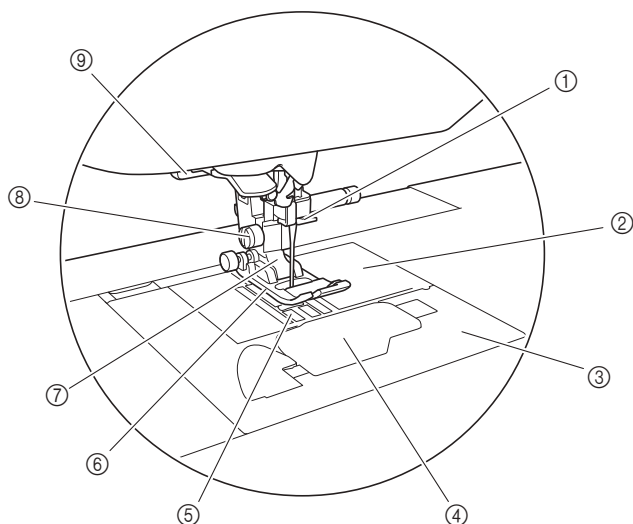

- ① **Needle bar thread guide**
Pass the upper thread through the needle bar thread guide.
- ② **Needle plate**
The needle plate is marked with guides for sewing straight seams.
- ③ **Needle plate cover**
Remove the needle plate cover to clean the bobbin case and race.
- ④ **Bobbin cover/bobbin case**
Remove the bobbin cover and then insert the bobbin into the bobbin case.
- ⑤ **Feed dogs**
The feed dogs feed the fabric in the sewing direction.
- ⑥ **Presser foot**
The presser foot applies pressure consistently on the fabric as the sewing takes place. Attach the appropriate presser foot for the selected stitch.
- ⑦ **Presser foot holder**
The presser foot is attached onto the presser foot holder.
- ⑧ **Presser foot holder screw**
Use the presser foot holder screw to hold the presser foot in place. (page B-34, B-53)
- ⑨ **Buttonhole lever**
Lower the buttonhole lever when sewing buttonholes and bar tacks or when darning.

Embroidery Unit

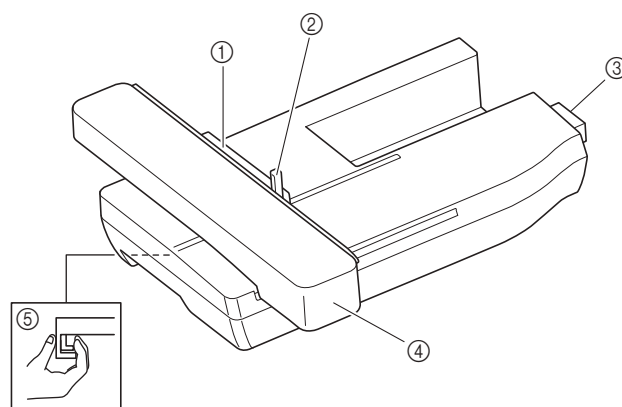



- ① **Embroidery frame holder**
Insert the embroidery frame into the embroidery frame holder to hold the frame in place. (page B-61)
- ② **Frame-securing lever**
Press the frame-securing lever down to secure the embroidery frame. (page B-61)
- ③ **Embroidery unit connection**
Insert the embroidery unit connection into the connection port when attaching the embroidery unit. (page B-54)
- ④ **Carriage**
The carriage moves the embroidery frame automatically when embroidering. (page B-54)
- ⑤ **Release button (located under the embroidery unit)**
Press the release button to remove the embroidery unit. (page B-55)

CAUTION

- Before inserting or removing the embroidery unit, turn the main power to OFF.
- After the embroidery frame is set in the frame holder, be sure the frame-securing lever is correctly lowered.

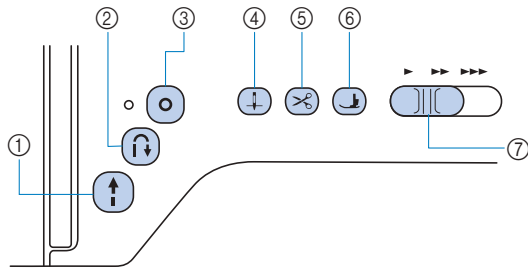
Operation buttons





- ① **“Start/Stop” button** 

Press the “Start/Stop” button to start or stop sewing. The machine stitches at a slow speed at the beginning of sewing while the button is pressed. When sewing is stopped, the needle is lowered in the fabric. For details, refer to “STARTING TO SEW” on page B-35.
The button changes color according to the machine’s operation mode.

 - Green: The machine is ready to sew or is sewing.
 - Red: The machine can not sew.
 - Orange: The machine is winding the bobbin thread, or the bobbin winder shaft is moved to the right side.
- ② **Reverse stitch button** 

For straight, zigzag, and elastic zigzag stitch patterns that use reverse stitches, the machine will sew reverse stitches at low speed only while holding down the Reverse stitch button. The stitches are sewn in the opposite position.
For other stitches, use this button to sew reinforcement stitches at the beginning and end of sewing. Press and hold this button, and the machine sews 3 stitches in the same spot and stops automatically. (page B-39)
- ③ **Reinforcement stitch button** 

Use this button to sew a single stitch repeatedly and tie-off.
For character/decorative stitches, press this button to end with a full stitch instead of at a mid-point. The LED light beside this button lights up while the machine is sewing a full motif, and automatically turns off when the sewing is stopped. (page B-38)
- ④ **Needle position button** 

Press the needle position button to raise or lower the needle. Pressing the button twice sews one stitch.
- ⑤ **Thread cutter button** 

Press the thread cutter button after sewing is stopped to cut both the upper and the bobbin threads. For details, refer to step 12 under the “Sewing a stitch” section on page B-36.
- ⑥ **Presser foot lifter button** 

Press this button to lower the presser foot and apply pressure to the fabric. Press this button again to raise the presser foot.
- ⑦ **Sewing speed controller**

Slide the sewing speed controller to adjust the sewing speed.

CAUTION

- Do not press  (Thread cutter button) after the threads have already been cut, otherwise the needle may break, the threads may become tangled or damage to the machine may occur.

Operation panel and operation keys

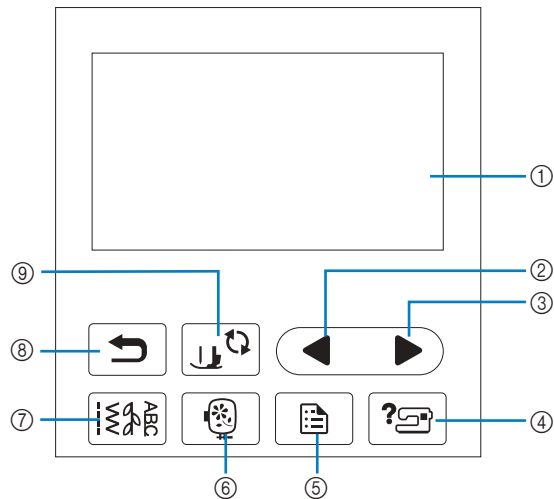



- ① **LCD (liquid crystal display) (touch panel)**

Selected pattern settings and messages are displayed. Touch the keys displayed on the LCD to perform operations. For details, refer to “LCD Operation” on page B-11.
- ② **Previous page key** 

Displays the previous screen when there are items that are not displayed on the LCD.
- ③ **Next page key** 

Displays the next screen when there are items that are not displayed on the LCD.
- ④ **Help key** 

Press to get help on using the machine.
- ⑤ **Settings key** 

Press to set the needle stop position, the buzzer sound, and more.
- ⑥ **Embroidery key** 

Press this key to sew embroidery.
- ⑦ **Utility stitch key** 

Press this key to select a utility stitch or decorative stitch.
- ⑧ **Back key** 

Press to return to the previous screen.
- ⑨ **Presser foot/Needle exchange key** 

Press this key before changing the needle, the presser foot, etc. This key locks all key and button functions to prevent operation of the machine.

Note

- The operation keys of this machine are capacitive touch sensors. Operate the keys by directly touching them with your finger. The response of the keys varies according to the user. The pressure exerted on the keys does not affect the response of the keys.
- Since the operation keys react differently depending on the user, adjust the setting for “Adjusting input sensitivity for operation keys” on page B-16.
- When using an electrostatic touch pen, make sure that its point is 8 mm or more. Do not use a touch pen with a thin point or a unique shape.

Using the flat bed attachment

Pull the top of the flat bed attachment to open the accessory compartments.

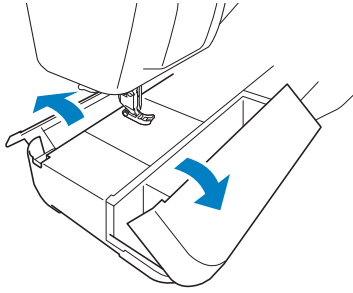

A presser foot accessory tray is stored in the accessory compartment of the flat bed attachment.

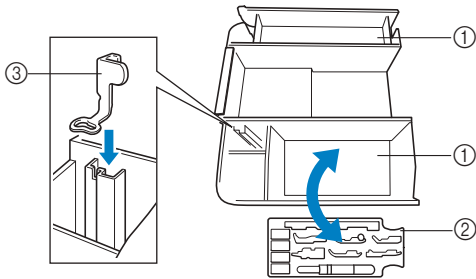

- ① Storage space of the flat bed attachment
- ② Presser foot accessory tray
- ③ Embroidery foot "U"

Included accessories

Included accessories may differ from the table below depending on the machine model you purchased. For more details on included accessories and their part codes of your machine, refer to the Quick Reference Guide.

| | | | | | |
|--|---|---|---|---|---|
| <p>1.</p> <p>J</p> <p>Zigzag foot "J" (on machine)</p> | <p>2.</p> <p>N</p> <p>Monogramming foot "N"</p> | <p>3.</p> <p>G</p> <p>Overcasting foot "G"</p> | <p>4.</p> <p>I</p> <p>Zipper foot "I"</p> | <p>5.</p> <p>R</p> <p>Blind stitch foot "R"</p> | <p>6.</p> <p>M</p> <p>Button fitting foot "M"</p> |
| <p>7.</p> <p>A</p> <p>Buttonhole foot "A"</p> | <p>8.</p> <p>U</p> <p>Embroidery foot "U"</p> | <p>9.</p> <p>Open toe foot</p> | <p>10.</p> <p>O</p> <p>Free motion open toe quilting foot "O"</p> | <p>11.</p> <p>Non stick foot</p> | <p>12.</p> <p>P</p> <p>Stitch guide foot "P"</p> |
| <p>13.</p> <p>Adjustable zipper/piping foot</p> | <p>14.</p> <p>Needle set 75/11 2 needles, 90/14 2 needles, 90/14 2 needles: Ball point needle (gold colored)</p> | <p>15.</p> <p>Twin needle 2.0/11 needle</p> | <p>16.</p> <p>Bobbin (4) One is on machine.</p> | <p>17.</p> <p>Seam ripper</p> | <p>18.</p> <p>Scissors</p> |
| <p>19.</p> <p>Cleaning brush</p> | <p>20.</p> <p>Eyelet punch</p> | <p>21.</p> <p>Screwdriver (large)</p> | <p>22.</p> <p>Screwdriver (small)</p> | <p>23.</p> <p>L-shaped screwdriver</p> | <p>24.</p> <p>Disc-shaped screwdriver</p> |
| <p>25.</p> <p>Horizontal spool pin</p> | <p>26.</p> <p>Spool cap (large)</p> | <p>27.</p> <p>Spool cap (medium) (2) One is on machine.</p> | <p>28.</p> <p>Spool cap (small)</p> | <p>29.</p> <p>Thread spool insert (mini king thread spool)</p> | <p>30.</p> <p>Spool net</p> |
| <p>31.</p> <p>Knee lifter</p> | <p>32.</p> <p>Standard bobbin case (green marking on the screw) (on machine)</p> | <p>33.*</p> <p>Alternate bobbin case (no color on the screw)</p> | <p>34.</p> <p>Foot controller</p> | <p>35.*</p> <p>Embroidery frame set (extra large) 26 cm (H) x 16 cm (W) (10-1/4 inches (H) x 6-1/4 inches (W))</p> | |
| <p>36.*</p> <p>Embroidery frame set (large) 18 cm (H) x 13 cm (W) (7 inches (H) x 5 inches (W))</p> | <p>37.*</p> <p>Embroidery bobbin thread (60 weight, white)</p> | <p>38.</p> <p>Accessory bag</p> | <p>39.</p> <p>Hard case</p> | <p>40.</p> <p>Grid sheet set</p> | |
| <p>41.</p> <p>Operation Manual</p> | <p>42.</p> <p>Quick Reference Guide</p> | <p>43.</p> <p>Embroidery Design Guide</p> | | | |

* These accessories are included in the same box as the embroidery unit.

**Note**

- (For U.S.A. only) Foot controller: Model T
This foot controller can be used on the machine with product code 888-G00. The product code is mentioned on the machine rating plate.
- The presser foot holder screw is available through your authorized Brother dealer. (Part code: XG1343-001)
- The presser foot accessory tray is available, through your authorized Brother dealer. (Part code: XF8650-001)

Optional accessories



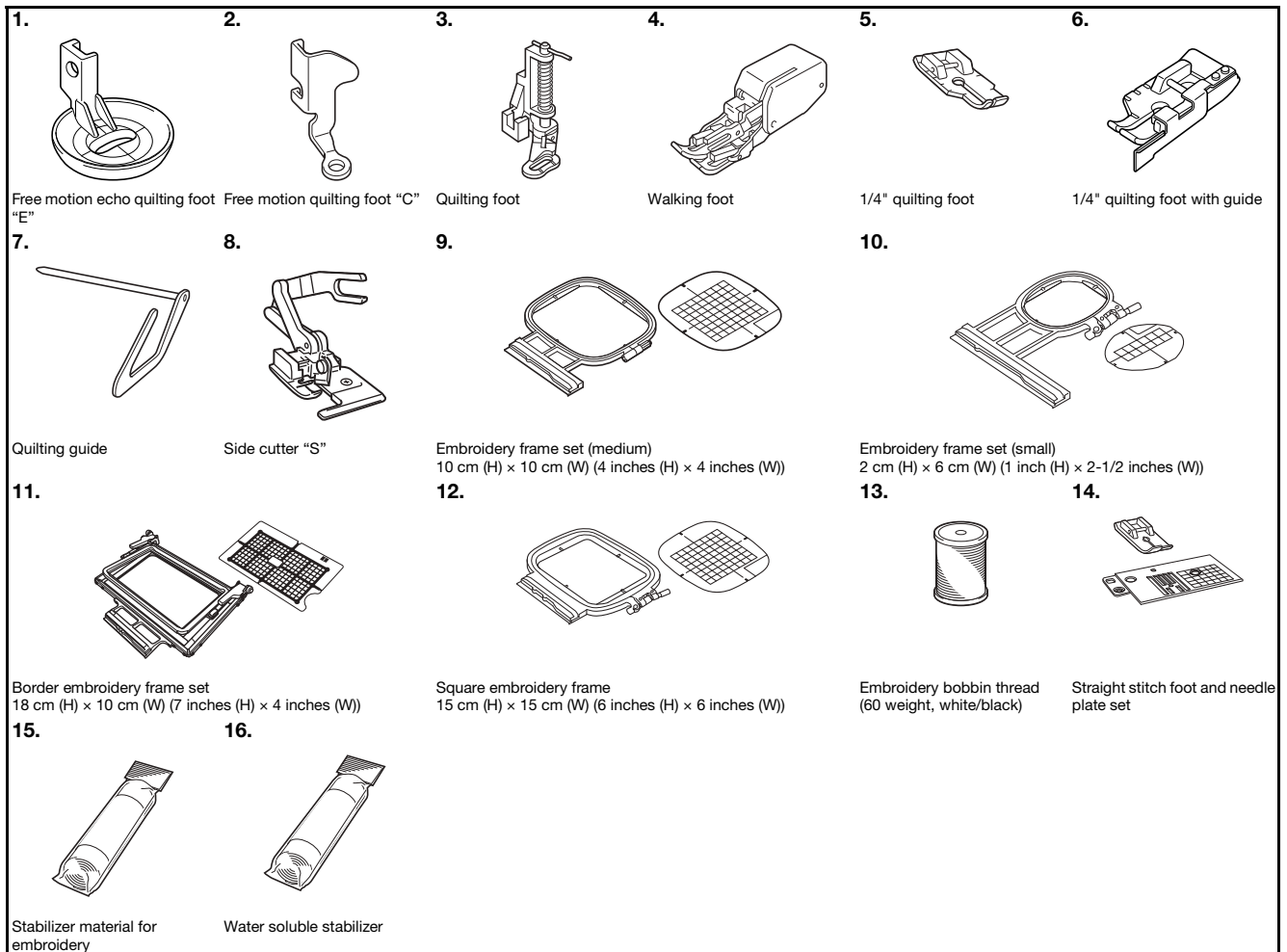



The following are available as optional accessories to be purchased separately. For more optional accessories and their part codes, refer to the Quick Reference Guide.

**Memo**

- To obtain optional accessories or parts, contact your authorized Brother dealer.
- All specifications are correct at the time of printing. Please be aware that some specifications may change without notice.
- Visit your nearest authorized Brother dealer for a complete listing of optional accessories available for your machine.
- Always use accessories recommended for this machine.

Using the utility stitch tables in the “Sewing” section

The utility stitch numbers differ depending on the model of your machine. Refer to the column titled “Model 4” for your machine.

| Stitch name | Stitch | Model 4 |  | | Presser foot |
|--------------------------|---|---------------|---|---------|--------------|
| | | | Model 3, 2 | Model 1 | |
| | | Stitch number | | | |
| Basting stitch |  | 1-08 | 08 | 07 | J |
| Straight stitch (Left) |  | 1-01 | 01* | 01* | |
| |  | 1-02 | 02* | 02* | |
| Straight stitch (Middle) |  | 1-03 | 03* | 03* | |
| Triple stretch stitch |  | 1-05 | 05* | 05* | |

Turning the Machine On/Off

WARNING

- Use only regular household electricity for the power source. Using other power sources may result in fire, electric shock, or damage to the machine.
- Make sure that the plugs on the power cord are firmly inserted into the electrical outlet and the power cord receptacle on the machine. Otherwise, a fire or electric shock may result.
- Do not insert the plug on the power cord into an electrical outlet that is in poor condition.
- Turn the main power to OFF and remove the plug in the following circumstances:
 - When you are away from the machine
 - After using the machine
 - When the power fails during use
 - When the machine does not operate correctly due to a bad connection or a disconnection
 - During electrical storms

CAUTION

- Use only the power cord included with this machine.
- Do not use extension cords or multi-plug adapters with any other appliances plugged into them. Fire or electric shock may result.
- Do not touch the plug with wet hands. Electric shock may result.
- When unplugging the machine, always turn the main power to OFF first. Always grasp the plug to remove it from the electrical outlet. Pulling on the cord may damage the cord, or lead to fire or electric shock.
- Do not allow the power cord to be cut, damaged, modified, forcefully bent, pulled, twisted, or bundled. Do not place heavy objects on the cord. Do not subject the cord to heat. These things may damage the cord, or cause fire or electric shock. If the cord or plug is damaged, take the machine to your authorized Brother dealer for repairs before continuing use.
- Unplug the power cord if the machine is not to be used for a long period of time. Otherwise, a fire may result.
- When leaving the machine unattended, either the main switch of the machine should be turned to OFF or the plug must be removed from the electrical outlet.
- When servicing the machine or when removing covers, the machine must be unplugged.
- For USA only
 - This appliance has a polarized plug (one blade wider than the other). To reduce the risk of electrical shock, this plug is intended to fit in a polarized electrical outlet only one way.
 - If the plug does not fit fully in the electrical outlet, reverse the plug. If it still does not fit, contact a qualified electrician to install the proper electrical outlet. Do not modify the plug in any way.

Turning on the machine

- 1 Make sure that the machine is turned off (the main power switch is set to "O"), and then plug the power cord into the power supply jack on the right side of the machine.
- 2 Insert the plug of the power cord into a household electrical outlet.

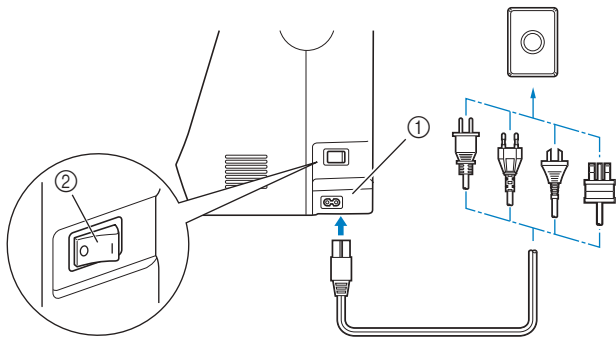

- 1 Power supply jack
- 2 Main power switch

- 3 Press the right side of the main power switch on the right side of the machine to turn the machine on (set it to "I").

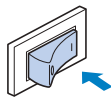

→ The light, LCD and the "Start/Stop" button light up when the machine is turned on.

Memo

- When the machine is turned on, the needle and the feed dogs will make a sound when they move; this is not a malfunction.
- If the machine is turned off in the middle of sewing in the "Sewing" function, the operation will not be resume after turning the power on again.

- 4 When the machine is turned on, the opening movie is played. Press anywhere on the screen.

Turning off the machine

When you are finished using the machine, turn it off. In addition, before transporting the machine to another location, be sure to turn it off.

- 1 Make sure that the machine is not sewing.
- 2 Press the main power switch on the right side of the machine in the direction of the "O" symbol to turn the machine off.

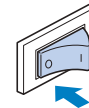

Select machine setting for the first time

When you first turn on the machine, select the language of your choice. Follow the procedure below when the settings screen appears automatically.

- 1 Press  and  to select your choice of language.



- 2 Press .

LCD Operation

Viewing the LCD

An opening movie may be displayed when the power is turned on. When the opening movie is displayed, the screen will be displayed if you touch the LCD with your finger. Press a key with your finger to select the stitch pattern, to select a machine function, or to select an operation indicated on the key.

The screen below appears when you press  on the operation panel.

This section contains a description of the utility stitch screen, which appears when any of the keys indicated by ① is pressed.

Pressing any of the keys indicated by ② displays the character/decorative stitch screen. For details, refer to the “Decorative sewing” section.

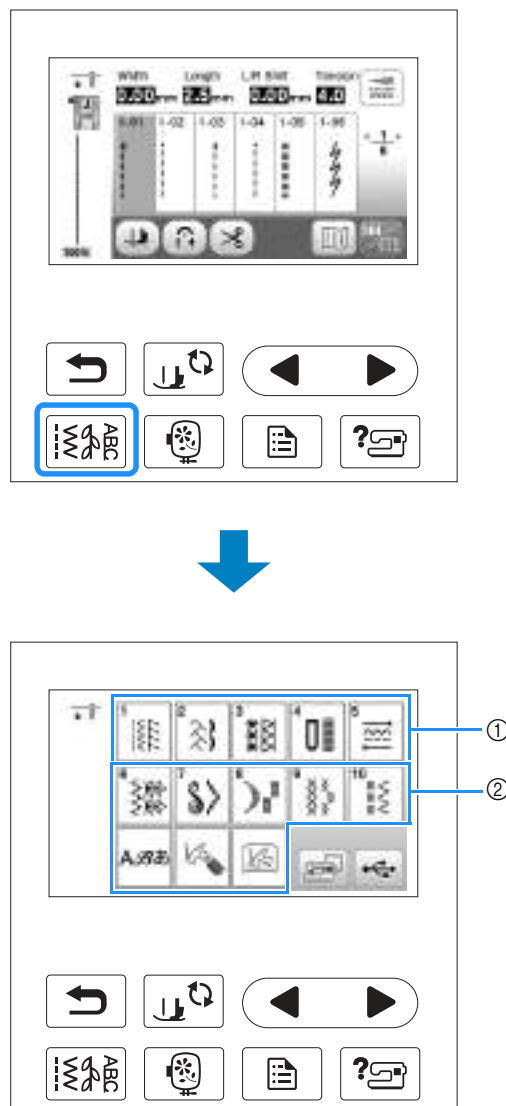



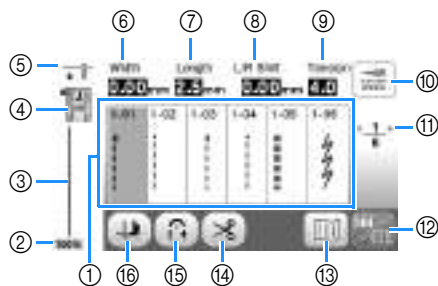

■ Utility stitch screen

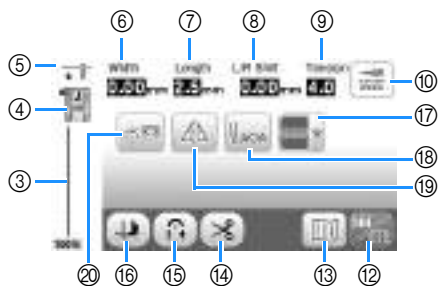



■ Utility stitch editing screen



| No. | Display | Key Name | Explanation | Page |
|-----|---------|-------------------------------------|--|------|
| ① | - | Stitches | Press the key for the pattern you want to sew. | B-35 |
| ② | 100% | Pattern display size | Show the approximate size of the pattern selected. 100%: Nearly the same size as the sewn pattern 50%: 1/2 the size of the sewn pattern 25%: 1/4 the size of the sewn pattern The actual size of the sewn pattern may differ depending on the type of fabric and thread that is used. | - |
| ③ | - | Stitch preview | Shows a preview of the selected stitch. Approximate size of the pattern selected shows at the bottom of the stitch preview. When shown at 100%, the stitch appears in the screen at nearly its actual size. | B-35 |
| ④ | | Presser foot | Shows presser foot to be used. | B-33 |
| ⑤ | | Needle position setting | Shows single or twin needle mode setting, and the needle stop position. ↓↑ : Single needle/down position ↑↓ : Single needle/up position ↓W : Twin needle/down position ↑W : Twin needle/up position | B-13 |
| ⑥ | | Stitch width | Shows the stitch width of the currently selected stitch pattern. | B-40 |
| ⑦ | | Stitch length | Shows the stitch length of the currently selected stitch pattern. | B-40 |
| ⑧ | | L/R Shift | Shows the tendency of left/right of the center line for the original zigzag stitch. | B-41 |
| ⑨ | | Thread tension | Shows the automatic thread tension setting for the currently selected stitch pattern. | B-41 |
| ⑩ | | Manual adjustment key | Press this key to display the following manual adjustment screen. You can adjust the value of each item by pressing - / + .  ① Press to save stitch settings to machine memory (Width/Length/L/R Shift/Tension). ② Press to return the stitch settings to default. | B-42 |
| ⑪ | | Page display | Shows additional pages that can be displayed. | - |
| ⑫ | | Edit/stitch switching key | Press this key to switch to the utility stitch editing screen. | - |
| ⑬ | | Image key | Shows a preview of the sewn image. | - |
| ⑭ | | Automatic thread cutting key | Press this key to set the automatic thread cutting function. | B-43 |
| ⑮ | | Automatic reverse/reinforcement key | Press this key to use the automatic reverse/reinforcement stitch function. | B-38 |
| ⑯ | | Pivot key | Press this key to select the pivot function. | B-44 |
| ⑰ | | Single/repeat sewing key | Press this key to choose single pattern or continuous patterns. Depending on the selected stitch, this key may be disabled. | - |

| No. | Display | Key Name | Explanation | Page |
|-----|---|-----------------------|---|------|
| ⑱ |  | Back to beginning key | When sewing is stopped, press this key to return to the beginning of the pattern. For details, refer to “Returning to the beginning of the pattern” in the “Decorative sewing” section. | – |
| ⑲ |  | Mirror image key | After selecting the stitch pattern, use this key to create a horizontal mirror image of the stitch pattern. | B-43 |
| ⑳ |  | Free motion mode key | Press this key to enter free motion sewing mode. | B-45 |

Using the settings key

Press  to change the default machine settings (needle stop position, embroidery speed, opening display, etc.). Press  or , after you changed necessary settings.

■ Sewing settings

Page 1



Page 2



Page 3



- ① Select whether to use the sewing speed controller to determine the zigzag width. For details, refer to “Satin stitching using the sewing speed controller” in the “Sewing” section.
- ② Make adjustments to character or decorative stitch patterns. For details, refer to “Making adjustments” in the “Decorative sewing” section.
- ③ Set to “ON” when using twin needle. (page B-28)
- ④ Adjust the presser foot height. (Select the height of the presser foot when the presser foot is raised.)
- ⑤ Adjust the presser foot pressure. (The higher the number, the greater the pressure will be. Set the pressure at “3” for normal sewing.) (page B-43)
- ⑥ Select either “1-01 Straight stitch (Left)” or “1-03 Straight stitch (Middle)” as the utility stitch that is automatically selected when the machine is turned on.
- ⑦ Change the height of the presser foot when sewing is stopped when the pivot key is selected. Adjust the presser foot to one of the three heights (3.2 mm, 5.0 mm and 7.5 mm). (page B-44)
- ⑧ Change the height of the presser foot when the machine is set to free motion sewing mode (page B-45).
- ⑨ When set to “ON”, the thickness of the fabric is automatically detected by an internal sensor while sewing. This enables the fabric to be fed smoothly (page B-44).
- ⑩ When set “ON”, reinforcement stitches are sewn at the beginning and/or end of sewing for a reinforcement stitch pattern, even when the reverse button is pressed.

■ Embroidery settings

Page 4

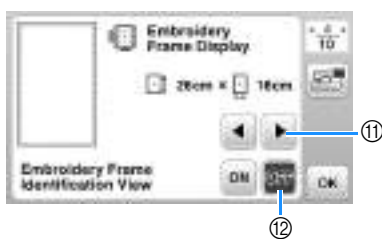

Page 5



Page 6

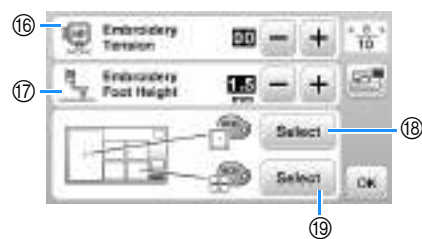

- ⑪ Select the embroidery frame to be used and displayed as a guide. For details, refer to “Changing the “Embroidery Frame Display”” in the “Embroidering” section.
- ⑫ When set to “ON”, the embroidery pattern can be selected according to the embroidery frame size that you have selected in number ⑪. For details, refer to “Selecting/displaying patterns according to the embroidery frame size” in the “Embroidering” section.
- ⑬ Change the thread color display on the “Embroidery” screen; thread number, color name. (page B-65).
- ⑭ When the thread number “#123” is selected, select from six thread brands. (page B-65).
- ⑮ Adjust the maximum embroidery speed setting. For details, refer to “Adjusting the embroidery speed” in the “Embroidering” section.
- ⑯ Adjust the upper thread tension for embroidering. For details, refer to “Adjusting thread tension” in the “Embroidering” section.
- ⑰ Select the height of the embroidery foot during embroidering. (page B-57).
- ⑱ Change the color of the background for the embroidery display area. For details, refer to “Changing the background colors of the embroidery patterns” in the “Embroidering” section.
- ⑲ Change the color of the background for the thumbnail area. For details, refer to “Changing the background colors of the embroidery patterns” in the “Embroidering” section.

Page 7



- ⑳ Press to specify the size of pattern thumbnails. For details, refer to “Specifying the size of pattern thumbnails” in the “Embroidering” section.
- ㉑ Change the display units (mm/inch).

■ General settings

Page 8



Page 9



Page 10





- ② Select the needle stop position (the needle position for when the machine is not being operated) to be up or down. Select the down position when using the pivot key. (page B-44)
- ③ Select whether to hear the beep operation sound. For details, refer to “Operation beep” in the “Appendix” section.
- ④ Select whether to display the opening screen when the machine is turned on.
- ⑤ Select the display language. (page B-16)
- ⑥ Select whether to turn on the light for the needle area and work area.
- ⑦ Select the level of the input sensitivity for operation keys. (page B-16)
- ⑧ Display the service count which is a reminder to take your machine in for regular servicing. (Contact your authorized Brother dealer for details.)
- ⑨ Display the total number of stitches sewn on this machine.
- ⑩ The “No.” is the internal machine number for your machine.
- ⑪ Display the program version of the LCD panel.



Memo

- The latest version of software is installed in your machine. Check with your local authorized Brother dealer or at “<http://support.brother.com/>” for available updates. For details, refer to “Upgrading your machine’s software using USB flash drive” in the “Appendix” section.
- Press to save the current settings screen image to USB flash drive. (page B-17)

■ Choosing the display language

- 1 Press .
- 2 Display page 8.
- 3 Use  and  to choose the display language.



① Display language



- 4 Press  to return to the original screen.

Adjusting input sensitivity for operation keys

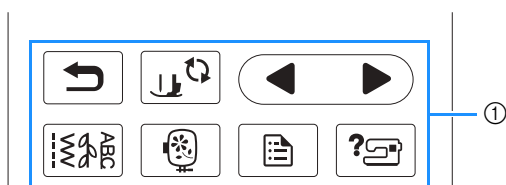
You can adjust the sensitivity of the operation keys to five levels. Display the settings screen to set desired level.



① Operation keys

- 1 Press  to display the settings screen.
- 2 Display page 9 by pressing .
- 3 Press "Start".



→ The adjusting screen is displayed.

- 4 Adjust the "Input Sensitivity" by pressing .

- The higher the setting, the more sensitive the keys will be. The default setting is "3".



Note

- We recommend selecting the highest setting if an electrostatic touch pen is being used.

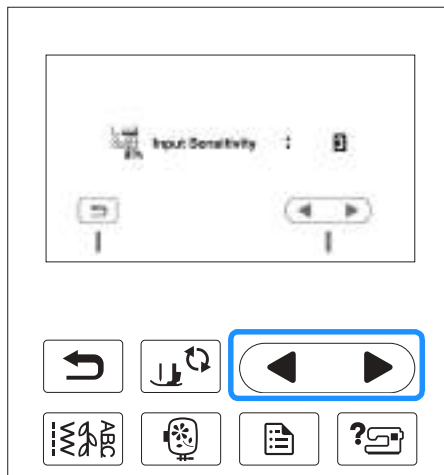

- 5 Press  to return to previous screen.



■ If the machine does not respond when an operation key is pressed

Hold down  (Thread cutter button) and turn on the machine to reset the settings. Display the settings screen, and then adjust the settings again.

Saving a settings screen image to USB flash drive

An image of the settings screen can be saved as a BMP file.

- 1 Insert the USB flash drive into the USB port on the right side of the machine.

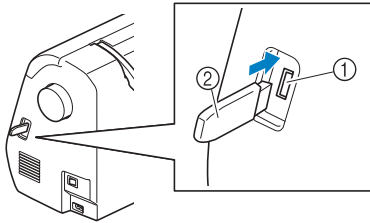

- 1 USB port
- 2 USB flash drive

- 2 Press .
 - The settings screen appears. Select the settings screen page, make the changes that you want, and then save the screen image.

- 3 Press .
 - The image file will be saved to the USB flash drive.

- 4 Remove the USB flash drive, and then for future reference, check the saved image using a computer.
 - The files for settings screen images are saved with the name "S#####.bmp" in a folder labeled "bPocket".

Checking machine operating procedures

- 1 Turn on the machine.
 - The LCD comes on.
- 2 Press anywhere on the LCD screen.
- 3 Press on the operation panel.

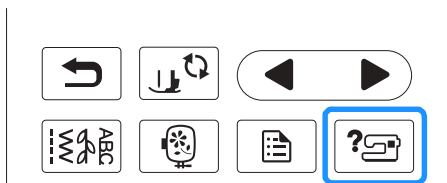

→ The machine help screen appears.

- 4 Press the item to be displayed.

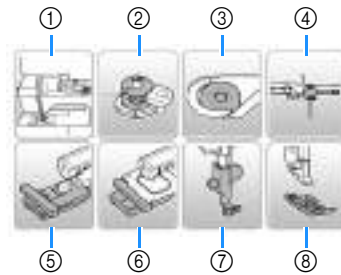

- 1 Upper threading
- 2 Bobbin winding
- 3 Bobbin installation
- 4 Needle replacement
- 5 Embroidery unit attachment
- 6 Embroidery frame attachment
- 7 Embroidery foot attachment
- 8 Presser foot replacement

→ The first screen describing the procedure for the selected topic appears.

- Pressing , returns you to the item selection screen.

- 5 Press to switch to the next page.

If you press , you return to the previous page.

- 6 After you have finished viewing, press two times.

Winding/Installing the Bobbin

⚠ CAUTION

- Only use the Bobbin (part code: SA156, SFB: XA5539-151) designed specifically for this machine. Use of any other bobbin may result in injuries or damage to the machine.
- The included bobbin was designed specifically for this machine. If bobbins from other models are used, the machine will not operate correctly. Use only the included bobbin or bobbins of the same type (part code: SA156, SFB: XA5539-151). SA156 is Class15 type bobbin.

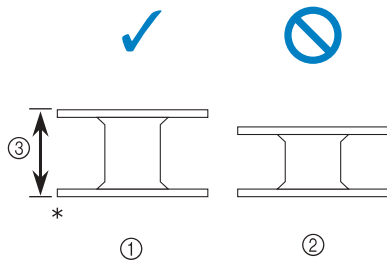

- * Actual size
- ① This model
 - ② Other models
 - ③ 11.5 mm (approx. 7/16 inch)

📖 Memo

- When the foot controller is connected, bobbin winding can be started and stopped with the foot controller.

Winding the bobbin

This section describes how to wind thread onto a bobbin.

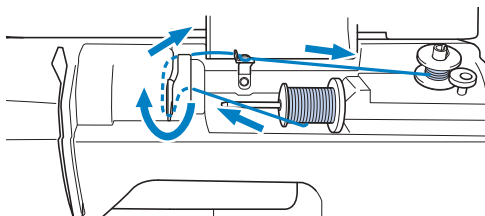

📖 Memo

- When winding bobbin for embroidery be sure to use the recommended bobbin thread for this machine.

- 1 Open the top cover.

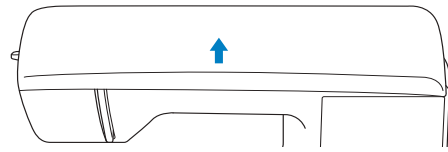

- 2 Place the bobbin on the bobbin winder shaft so that the spring on the shaft fits into the notch in the bobbin. Press down on the bobbin until it snaps into place.

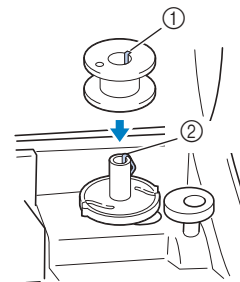

- ① Notch
- ② Bobbin winder shaft spring

- 3 Slide the bobbin winder in the direction of the arrow until it snaps into place.

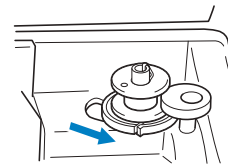

- The "Start/Stop" button lights up in orange.

- 4 Remove the spool cap that is inserted onto the spool pin.

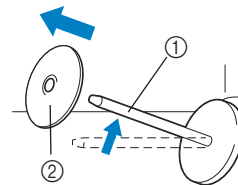

- ① Spool pin
- ② Spool cap

5 Place the spool of thread for the bobbin onto the spool pin.

Slide the spool onto the pin so that the spool is horizontal and the thread unwinds to the front at the bottom.

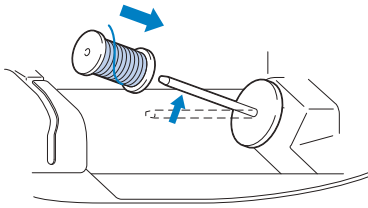

- If the spool is not positioned so that the thread unwinds correctly, the thread may become tangled around the spool pin.

6 Slide the spool cap onto the spool pin.

Slide the spool cap as far as possible to the right, as shown, with the rounded side on the left.

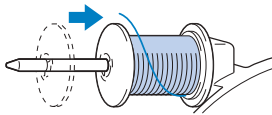

⚠ CAUTION

- If the spool or the spool cap is not installed correctly, the thread may become tangled around the spool pin, causing the needle to break.
- Three spool cap sizes are available, allowing you to choose a spool cap that best fits the size of spool being used. If the spool cap is too small for the spool being used, the thread may catch on the slit in the spool or the machine may be damaged.

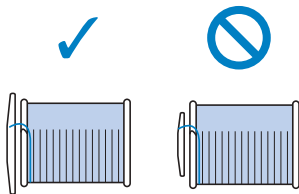

📖 Memo

- When sewing with fine, cross-wound thread, use the small spool cap, and leave a small space between the cap and the spool.

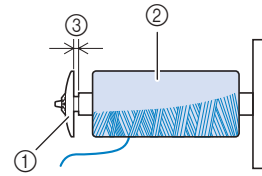

- ① Spool cap (small)
- ② Spool (cross-wound thread)
- ③ Space

- When using thread that winds off quickly, such as transparent nylon thread or metallic thread, place the spool net over the spool before placing the spool of thread onto the spool pin. If the spool net is too long, fold it to fit the size of the spool.

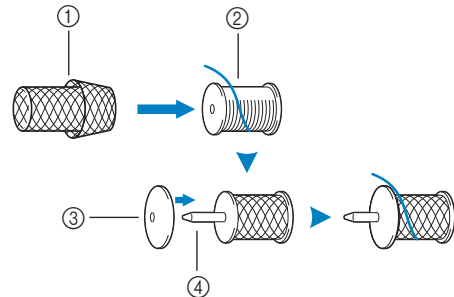

- ① Spool net
- ② Spool
- ③ Spool cap
- ④ Spool pin

- If a spool of thread whose core is 12 mm (1/2 inch) in diameter and 75 mm (3 inches) high is inserted onto the spool pin, use the thread spool insert (mini king thread spool).

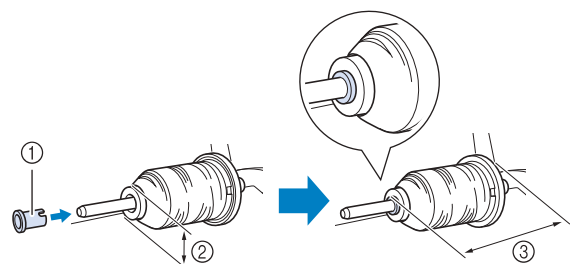

- ① Thread spool insert (mini king thread spool)
- ② 12 mm (1/2 inch)
- ③ 75 mm (3 inches)

- 7** While holding the thread near the spool with your right hand, as shown, pull the thread with your left hand, and then pass the thread behind the thread guide cover and to the front.

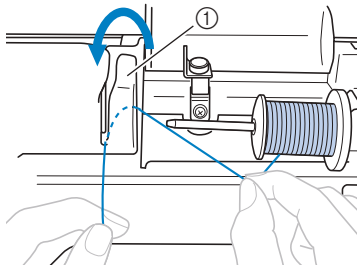

① Thread guide cover

- 8** Pass the thread under the thread guide plate, and then pull it to the right.

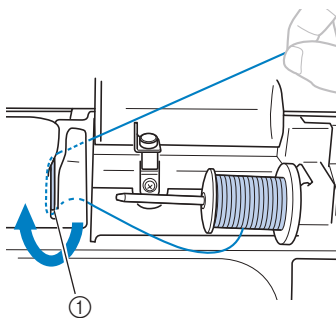

① Thread guide plate

- 9** Pass the thread under the hook on the thread guide, and then wind it counterclockwise under the pretension disk.

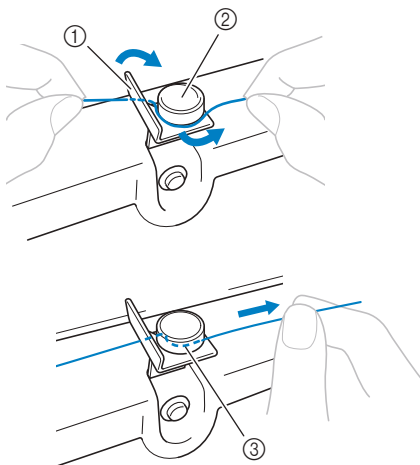

- ① Thread guide
② Pretension disk
③ Pull it in as far as possible



Note

- Make sure that the thread passes under the pretension disk.

- 10** While holding the thread with your left hand, wind the thread that was pulled out clockwise around the bobbin five or six times with your right hand.

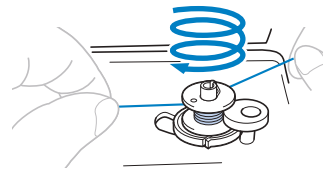

Note

- Make sure that the thread between the spool and the bobbin is pulled tight.
- Be sure to wind the thread clockwise around the bobbin, otherwise the thread will become wrapped around the bobbin winder shaft.

- 11** Pass the end of the thread through the guide slit in the bobbin winder seat, and then pull the thread to the right to cut it.

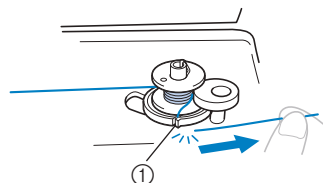

① Guide slit in bobbin winder seat (with built-in cutter)

CAUTION

- Be sure to cut the thread as described. If the bobbin is wound without cutting the thread using the cutter built into the slit in the bobbin winder seat, the thread may become tangled in the bobbin or the needle may bend or break when the bobbin thread starts to run out.

- 12** Slide the sewing speed controller to the right.

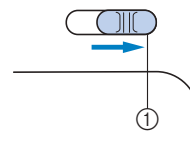

① Speed controller



Note

- Bobbin winding speeds may vary depending on type of thread being wound on bobbin.

- 13** Turn on the machine.

- 14** Press the “Start/Stop” button once to start winding the bobbin.
When the foot controller is plugged in, press down on the foot controller.



① “Start/Stop” button

- 15** When the bobbin winding becomes slow, press the “Start/Stop” button once to stop the machine.
When the foot controller is plugged in, remove your foot from the foot controller.

⚠ CAUTION

- When the bobbin winding becomes slow, stop the machine, otherwise the machine may be damaged.

- 16** Use scissors to cut the end of the thread wound around the bobbin.

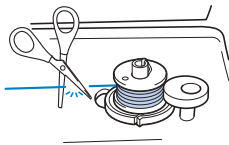

- 17** Slide the bobbin winder shaft to the left, and then remove the bobbin from the shaft.

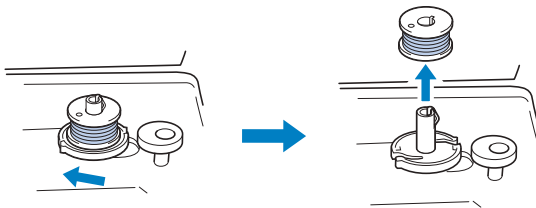

📖 Memo

- If the bobbin winder shaft is set to the right side, the needle will not move. (Sewing is impossible.)

- 18** Slide the sewing speed controller to desired sewing speed position.

- 19** Remove the spool for the bobbin thread from the spool pin.

📖 Memo

- When the machine is started or the handwheel is turned after winding the bobbin, the machine will make a clicking sound; this is not a malfunction.

Installing the bobbin

Install the bobbin wound with thread.

You can begin sewing immediately without pulling up the bobbin thread by simply inserting the bobbin in the bobbin case and guiding the thread through the slit in the needle plate cover.

📖 Memo

- For details on sewing after pulling up the bobbin thread, for example, when making gathers or with free motion quilting, refer to “Pulling up the bobbin thread” on page B-27.

⚠ CAUTION

- Use a bobbin that has been correctly wound with thread, otherwise the needle may break or the thread tension will be incorrect.

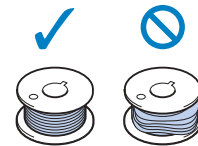

- Before inserting or changing the bobbin, be sure to press  on the operation panel to lock all keys and buttons, otherwise injuries may occur if the “Start/Stop” button or any other button is pressed and the machine starts.

- 1** Press  (Needle position button) once or twice to raise the needle.

- 2** Press .

- When the message “OK to automatically lower the presser foot?” appears on the LCD screen, press  to continue.

→ The screen changes, and all keys and operation buttons are locked (except .



- 3** Raise the presser foot lever.

- 4** Slide the bobbin cover latch to the right.

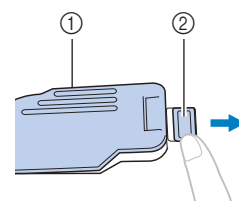

- ① Bobbin cover
② Latch

- 5 Remove the bobbin cover.
- 6 Hold the bobbin with your right hand with the thread unwinding to the left, and hold the end of the thread with your left hand. Then, with your right hand, place the bobbin in the bobbin case.

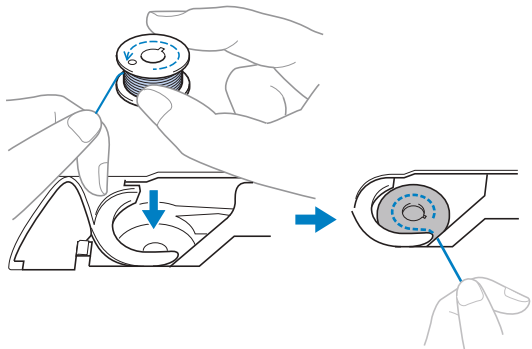

- 7 Lightly hold down the bobbin with your right hand (1), and then guide the end of the thread around the tab of the needle plate cover with your left hand (2).

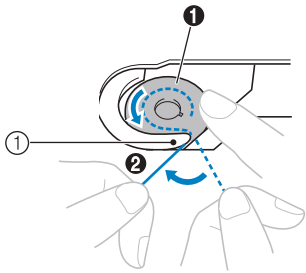

① Tab

⚠ CAUTION

- Be sure to hold down the bobbin with your finger and unwind the bobbin thread correctly, otherwise the thread may break or the thread tension will be incorrect.

📖 Memo

- The order that the bobbin thread should be passed through the bobbin case is indicated by marks around the bobbin case. Be sure to thread the machine as indicated.

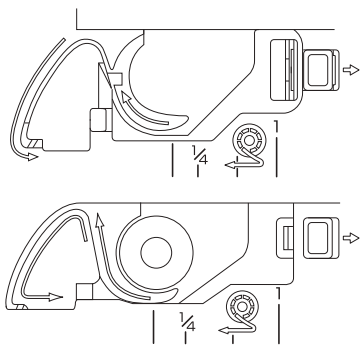

- 8 While lightly holding down the bobbin with your right hand (1), guide the thread through the slit in the needle plate cover (2) and lightly pull it with your left hand (3).

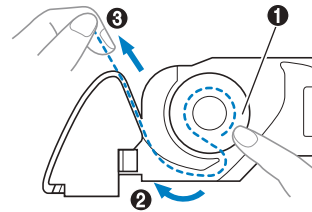

- 9 While lightly holding down the bobbin with your right hand (1), continue guiding the thread through the slit with your left hand (2). Then, cut the thread with the cutter (3).

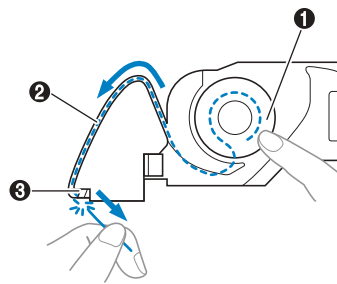

💡 Note

- If the thread is not correctly inserted through the tension-adjusting spring of the bobbin case, it may cause incorrect thread tension.

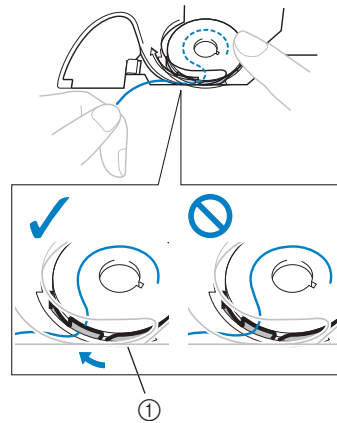

① Tension-adjusting spring

10 Reattach the bobbin cover.

Insert the tab in the lower-left corner of the bobbin cover, and then lightly press down on the right side.

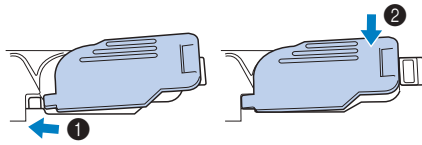

→ The bobbin threading is finished.

Next, thread the upper thread. Continue with the procedure in “Upper Threading” on page B-24.

**Memo**

- You can begin sewing without pulling up the bobbin thread. If you wish to pull up the bobbin thread before starting to sew, pull up the thread according to the procedure in “Pulling up the bobbin thread” on page B-27.

11 Press  to unlock all keys and buttons.

Upper Threading

⚠ CAUTION

- Three spool cap sizes are available, allowing you to choose a spool cap that best fits the size of spool being used. If the spool cap is too small for the spool being used, the thread may catch on the slit in the spool or the needle may break. For more information regarding the choice of spool caps for your thread choice, see page B-19.

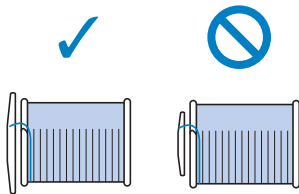

- When threading the upper thread, carefully follow the instructions. If the upper threading is not correct, the thread may become tangled or the needle may bend or break.
- Never use a thread weight of 20 or lower.
- Use the needle and the thread in the correct combination. For details on the correct combination of needles and threads, refer to "Fabric/thread/needle combinations" on page B-30.

Threading the upper thread

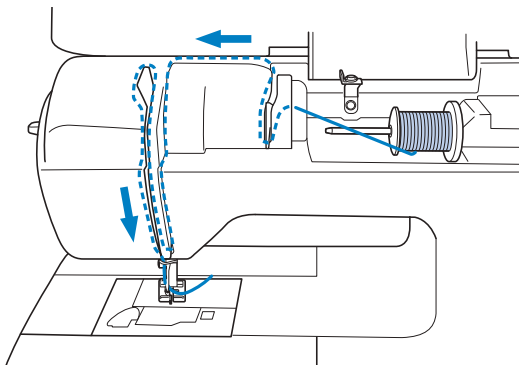

- 1 Turn on the machine.

- 2 Raise the presser foot lever to raise the presser foot.

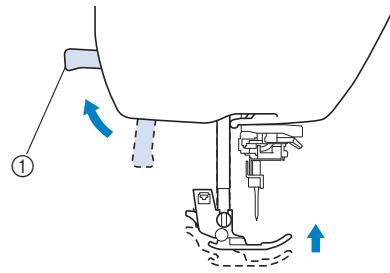

- 1 Presser foot lever

→ The upper thread shutter opens so the machine can be threaded.



Note

- If the presser foot is not raised, the machine cannot be threaded.

- 3 Press \oplus (Needle position button) once or twice to raise the needle.

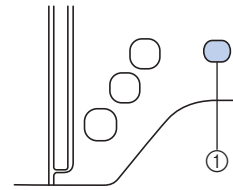

- 1 Needle position button

→ The needle is correctly raised when the mark on the handwheel is at the top, as shown below. Check the handwheel and, if this mark is not at this position, press \oplus (Needle position button) until it is.

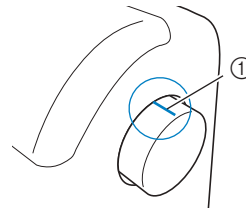

- 1 Mark on handwheel

- 4 Remove the spool cap that is inserted onto the spool pin.

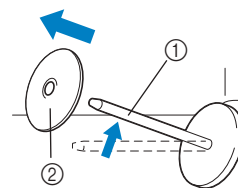

- 1 Spool pin
- 2 Spool cap

5 Place the spool of thread onto the spool pin.

Slide the spool onto the pin so that the spool is horizontal and the thread unwinds to the front at the bottom.

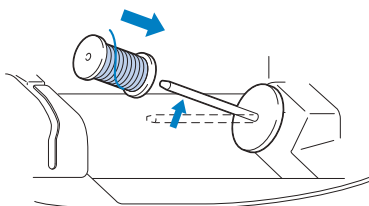
**⚠ CAUTION**

- If the spool or the spool cap is not positioned correctly, the thread may become tangled around the spool pin or the needle may break.

6 Slide the spool cap onto the spool pin.

Slide the spool cap as far as possible to the right, as shown, with the rounded side on the left.

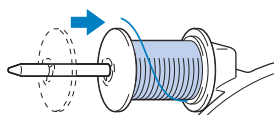
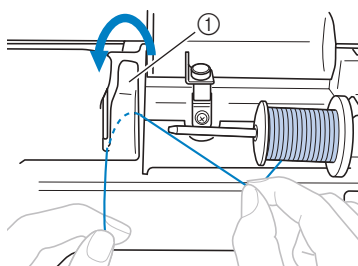
**7 While holding the thread lightly with your right hand, pull the thread with your left hand, and then pass the thread behind the thread guide cover and to the front.**

① Thread guide cover

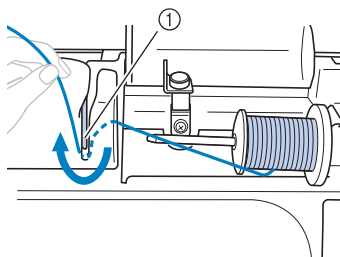
8 Pass the thread under the thread guide plate, and then pull it up.

① Thread guide plate

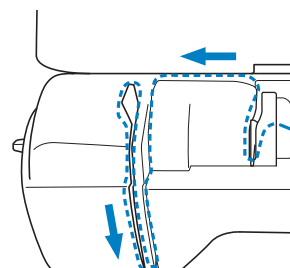
9 While using your right hand to lightly hold the thread passed under the thread guide plate, pass the thread through the guides in the order shown below.**Note**

- If the presser foot has been lowered and the shutter is closed, the machine cannot be threaded. Be sure to raise the presser foot to open the shutter before threading the machine. In addition, before removing the upper thread, be sure to raise the presser foot to open the shutter.
- This machine is equipped with a window that allows you to check the position of the take-up lever. Look through this window and check that the thread is correctly fed through the take-up lever.

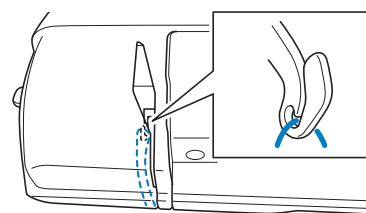
**10 Press .**

- When the message "OK to automatically lower the presser foot?" appears on the LCD screen, press  to continue.

→ The screen changes, and all keys and operation buttons are locked (except .

**11 Slide the thread behind the needle bar thread guide.**

The thread can easily be slid behind the needle bar thread guide by holding the thread in your left hand, then feeding the thread with your right hand, as shown.

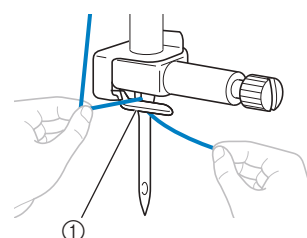

① Needle bar thread guide

12 Raise the presser foot lever.

Threading the needle

Memo

- The needle threader can be used with machine needles 75/11 through 100/16.
- The needle threader cannot be used with the wing needle or the twin needle.
- When thread such as transparent nylon monofilament or specialty threads are used it is not recommended to use the needle threader.
- If the needle threader cannot be used, refer to "Threading the needle manually (without using the needle threader)" on page B-27.

1 Pull the end of the thread, which has been passed through the needle bar thread guide, to the left, then pass the thread through the notch of the threader thread guide **1**, and then firmly pull the thread from the front and insert it into the slit of the threader thread guide disk marked "7" all the way **2**.

- Make sure that the thread passes through the notch of the threader thread guide.

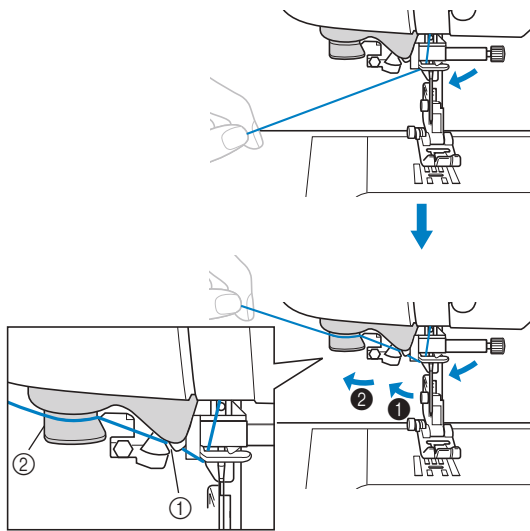

① Notch of the threader thread guide
② Threader thread guide disk

2 Cut the thread with the cutter on the left side of the machine.

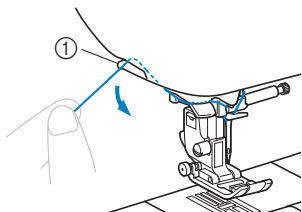

① Cutter

Note

- If the thread is pulled through and cannot be cut correctly, lower the presser foot lever so that the thread is held in place before cutting the thread. If this operation is performed, skip step **3**.
- When using thread that quickly winds off the spool, such as metallic thread, it may be difficult to thread the needle if the thread is cut. Therefore, instead of using the thread cutter, pull out about 80 mm (approx. 3 inches) of thread after passing it through the threader thread guide disks (marked "7").

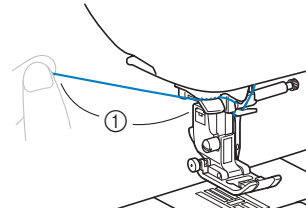

① 80mm (approx. 3 inches) or more

3 Lower the presser foot lever to lower the presser foot.

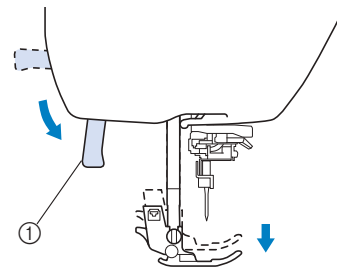

① Presser foot lever

4 Lower the needle threader lever on the left side of the machine until it clicks, and then slowly return the lever to its original position.

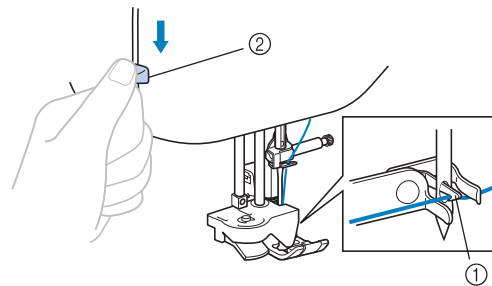

① Hook
② Needle threader lever

→ The hook is rotated and passes the thread through the eye of the needle.

Note

- If the needle is not raised to its highest position, the needle threader cannot thread the needle. Turn handwheel counterclockwise until the needle is at its highest position. The needle is correctly raised when the mark on the handwheel is at the top, as shown under step **3** on page B-24.

- 5** Carefully pull the end of thread that was passed through the eye of the needle.

If the needle was not completely threaded, but a loop in the thread was formed in the eye of the needle, carefully pull the loop through the eye of the needle to pull out the end of the thread.

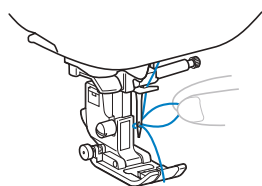

⚠ CAUTION

- When pulling out the thread, do not pull it with extreme force, otherwise the needle may break or bend.

- 6** Raise the presser foot lever, pass the end of the thread through and under the presser foot, and then pull out about 5 cm (approx. 2 inches) of thread toward the rear of the machine.

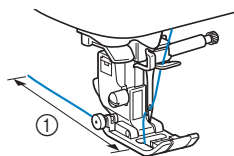

① 5 cm (approx. 2 inches)

- 7** Press  to unlock all keys and buttons.

Threading the needle manually (without using the needle threader)

When using specialty thread, such as transparent nylon thread, a wing needle or a twin needle which cannot be used with the needle threader, thread the needle as described below.

- 1** Thread the machine to the needle bar thread guide.
- For details, refer to “Upper Threading” on page B-24.
- 2** Insert the thread through the eye of the needle from front to back.

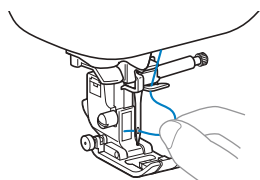



- 3** Raise the presser foot lever, pass the end of the thread through and under the presser foot, and then pull out about 5 cm (approx. 2 inches) of thread toward the rear of the machine.
- 4** Press  to unlock all keys and buttons.

Pulling up the bobbin thread

When making gathers or before free motion quilting, first pull up the bobbin thread as described below.

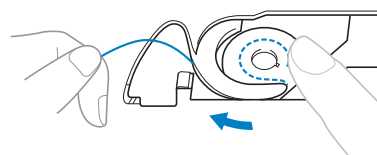
- 1** Refer to “Threading the upper thread” (page B-24) to thread the machine with the upper thread and thread the needle.
- 2** Follow steps **4** to **6** in “Installing the bobbin” (page B-21) for installing the bobbin to insert the bobbin into the bobbin case.
- 3** Pass the bobbin thread through the slot.
- Do not cut the thread with the cutter.



- 4** While lightly holding the upper thread with your left hand, press  (Needle position button) twice to raise the needle.

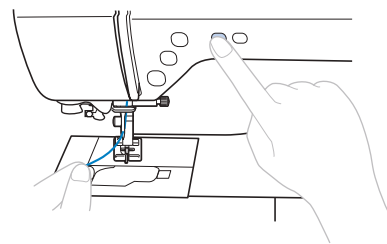

→ The bobbin thread is looped around the upper thread and can be pulled up.

- 5** Carefully pull the upper thread upward to pull out the end of the bobbin thread.

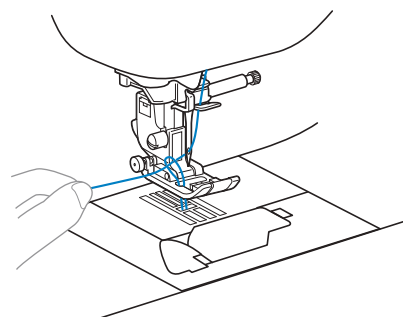

- 6** Pull up the bobbin thread, pass it under the presser foot and pull it about 10 cm (4 inches) toward the back of the machine, making it even with the upper thread.

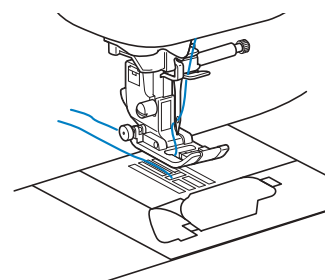

- 7 Reattach the bobbin cover.**
 Insert the tab in the lower-left corner of the bobbin cover, and then lightly press down on the right side.

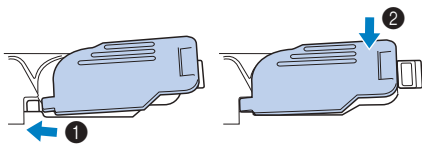

Using the twin needle

With the twin needle, you can sew two parallel lines of the same stitch with two different threads. Both upper threads should have the same thickness and quality. Be sure to use the twin needle, the horizontal spool pin and the appropriate spool caps.

For details on the stitches that can be sewn with the twin needle, refer to “Stitch Setting Chart” beginning on page B-47.

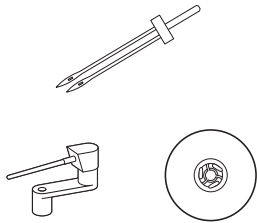

Memo

- Traditionally a twin needle is also used for creating pin tucks. Contact your nearest authorized Brother dealer to obtain the optional pin tuck foot for your machine (SA194, F069: XF5832-001).

CAUTION

- Only use the twin needle (2.0/11 needle, part code: X59296-121). Use of any other needle may bend the needle or damage the machine.
- Never use bent needles. Bent needles can easily break, possibly resulting in injuries.
- The needle threader cannot be used with the twin needle. If the needle threader is used with the twin needle, the machine may be damaged.

- 1 Install the twin needle.**
 For details on installing a needle, refer to “Replacing the needle” on page B-31.
- 2 Thread the upper thread for the left needle eye.**
 For details, refer to steps 1 through 11 of “Threading the upper thread” on page B-24.

- 3 Manually thread the left needle with the upper thread.**
 Pass the thread through the eye of the needle from the front.

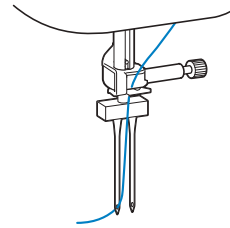

- 4 Insert the horizontal spool pin onto the bobbin winder shaft.**
 Insert the spool pin so that it is perpendicular to the bobbin winder shaft.

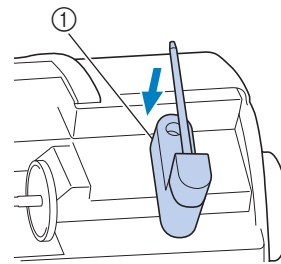

① Bobbin winder shaft

- 5 Swing the spool pin toward the left so that it is horizontal.**

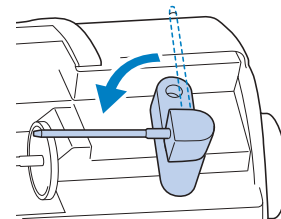

- 6 Place the upper thread spool for the needle on the right side onto the spool pin, and then secure it with the spool cap.**

The thread should unroll from the top front of the spool.

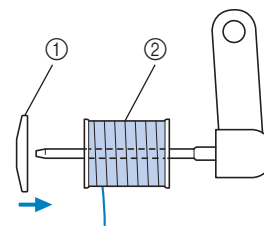

① Spool cap
 ② Spool

- 7 Thread the upper thread in the same way that the upper thread for the left side was threaded.

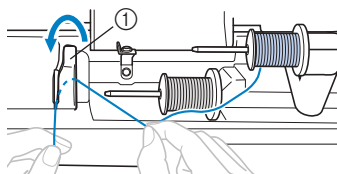

- ① Thread guide cover
- For details, refer to steps 7 through 9 of "Threading the upper thread" on page B-24.

- 8 Without passing the thread through the needle bar thread guide, manually thread the right needle.

Insert the thread through the eye of the needle from the front.

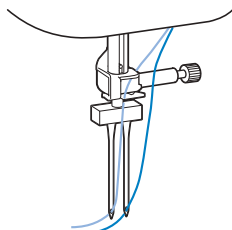

- The needle threader cannot be used with the twin needle. If the needle threader is used with the twin needle, the machine may be damaged.

- 9 Attach zigzag foot "J".

- For details on changing the presser foot, refer to "Replacing the presser foot" on page B-33.

CAUTION

- When using the twin needle, be sure to attach zigzag foot "J". If bunched stitches occur, use presser foot "N" or attach stabilizer material.

- 10 Turn on the machine and select a stitch.

- For stitch selection see "Sewing a stitch" on page B-35.
- See "Stitch Setting Chart" on page B-47 for stitches that use a twin needle.

CAUTION

- When using the twin needle, be sure to select an appropriate stitch, otherwise the needle may break or the machine may be damaged.

- 11 Press  to display the settings screen.

- 12 Set "Twin Needle" to "ON."



- 13 Press .

CAUTION

- When using the twin needle, be sure to select the twin needle setting, otherwise the needle may break or the machine may be damaged.

- 14 Start sewing.

- For details on starting to sew, refer to "STARTING TO SEW" on page B-35.
- Two lines of stitching are sewn parallel to each other.

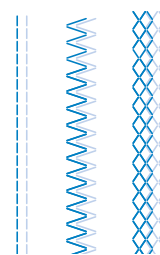

Note

- When changing the sewing direction, press  (Needle position button) to raise the needle from the fabric, and then raise the presser foot lever and turn the fabric.

CAUTION

- Do not try turning the fabric while the twin needle is down in the fabric, otherwise the needle may break or the machine may be damaged.

Replacing the Needle

Be sure to observe the following precautions concerning the handling of the needle. Failure to observe these precautions is extremely dangerous, for example, if the needle breaks and fragments are dispersed. Be sure to read and carefully follow the instructions below.

CAUTION

- Only use recommended home machine needles. Use of any other needle may bend the needle or damage the machine.
- Never use bent needles. Bent needles can easily break, possibly resulting in injuries.

Fabric/thread/needle combinations

The machine needle that should be used depends on the fabric and thread thickness. Refer to the following table when choosing the thread and needle appropriate for the fabric that you wish to sew.

| Fabric Type/Application | | Thread | | Size of Needle |
|-------------------------|--------------------|------------------|-------|--|
| | | Type | Size | |
| Medium weight fabrics | Broadcloth | Cotton thread | 60–90 | 75/11–90/14 |
| | Taffeta | Synthetic thread | | |
| | Flannel, Gabardine | Silk thread | 50 | |
| Thin fabrics | Lawn | Cotton thread | 60–90 | 65/9–75/11 |
| | Georgette | Synthetic thread | | |
| | Challis, Satin | Silk thread | 50 | |
| Heavy fabrics | Denim | Cotton thread | 30 | 100/16 |
| | | | 50 | 90/14–100/16 |
| | Corduroy | Synthetic thread | 50–60 | |
| Tweed | Silk thread | | | |
| Stretch fabrics | Jersey | Thread for knits | 50–60 | Ball point needle 75/11–90/14 (gold colored) |
| | Tricot | | | |
| Easily frayed fabrics | | Cotton thread | 50–90 | 65/9–90/14 |
| | | Synthetic thread | | |
| | | Silk thread | 50 | |
| For top-stitching | | Synthetic thread | 30 | 100/16 |
| | | Silk thread | 50–90 | 90/14–100/16 |



Note

- Never use thread of 20 weight or lower. It may cause the machine to malfunction.

■ Thread and needle number

The lower the thread number is, the heavier the thread; the higher the needle number, the larger the needle.

■ Ball point needle (gold colored)

To avoid skipped stitches use ball point needles (75/11–90/14) with stretch fabrics.

■ Transparent nylon thread

Use a 90/14 to 100/16 needle, regardless of the fabric or thread.

■ Embroidery needles

Use a 75/11 home machine needle. When embroidering on heavier fabrics such as denim, use a 90/14 or 100/16 home machine needle.

CAUTION

- The appropriate fabric, thread and needle combinations are shown in the table above. If the combination of the fabric, thread and needle is not correct, particularly when sewing heavy fabrics (such as denim) with thin needles (such as 65/9 to 75/11), the needle may bend or break. In addition, the stitching may be uneven or puckered or there may be skipped stitches.

Checking the needle

Sewing with a bent needle is extremely dangerous since the needle may break while the machine is being operated.

Before using the needle, place the flat side of the needle on a flat surface and check that the distance between the needle and the flat surface is even.

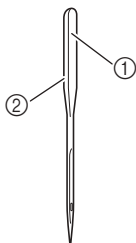

- ① Flat side
- ② Needle type marking

CAUTION

- If the distance between the needle and the flat surface is not even, the needle is bent. Do not use a bent needle.

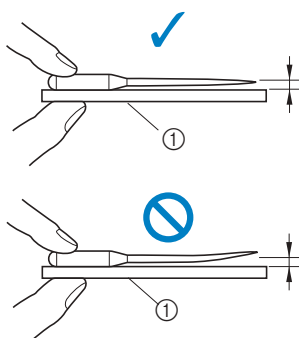

- ① Flat surface

Replacing the needle

Use the screwdriver and a needle that has been determined to be straight according to the instructions in "Checking the needle".

- 1 Press (Needle position button) once or twice to raise the needle.
- 2 Place fabric or paper under the presser foot to cover the hole in the needle plate.

Note

- Before replacing the needle, cover the hole in the needle plate with fabric or paper to prevent the needle from falling into the machine.

- 3 Press .

- When the message "OK to automatically lower the presser foot?" appears on the LCD screen, press to continue.

→ The screen changes, and all keys and operation buttons are locked (except .



- 4 Hold the needle with your left hand, and then use a screwdriver to turn the needle clamp screw toward you (counterclockwise) to remove the needle.

- The needle clamp screw can also be loosened or tightened with the L-shaped (or disc-shaped) screwdriver.

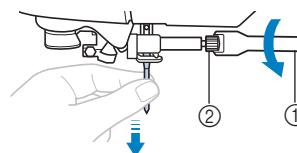

- ① Screwdriver
- ② Needle clamp screw

- Do not apply a strong force when loosening or tightening the needle clamp screw, otherwise certain parts of the machine may be damaged.

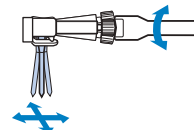

- 5 With the flat side of the needle toward the rear of the machine, insert the needle until it touches the needle stopper.

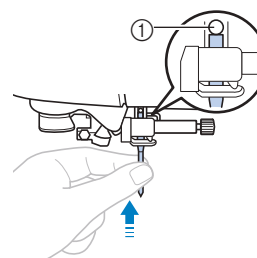

- ① Needle stopper

- 6 While holding the needle with your left hand, use the screwdriver to tighten the needle clamp screw by turning it clockwise.

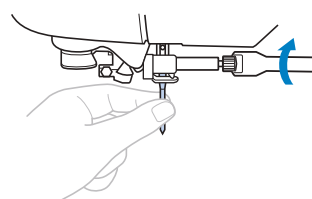

CAUTION

- Be sure to insert the needle until it touches the needle stopper and securely tighten the needle clamp screw with the screwdriver, otherwise the needle may break or damage may result.

7 Press  to unlock all keys and buttons.

Replacing the Presser Foot

⚠ CAUTION

- Use the presser foot appropriate for the type of stitch that you wish to sew, otherwise the needle may hit the presser foot, causing the needle to bend or break.
- Only use presser feet designed specifically for this machine. Use of any other presser foot may result in injuries or damage to the machine.

Replacing the presser foot

- 1 Press (Needle position button) once or twice to raise the needle.
- 2 Press .
 - When the message "OK to automatically lower the presser foot?" appears on the LCD screen, press to continue.
 - The screen changes, and all keys and operation buttons are locked (except).

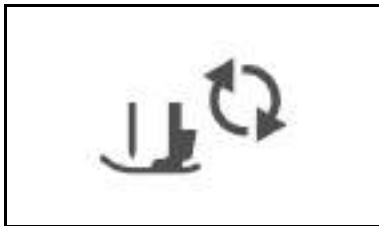

- 3 Raise the presser foot lever.
- 4 Press the black button at the back of the presser foot holder in order to remove the presser foot.

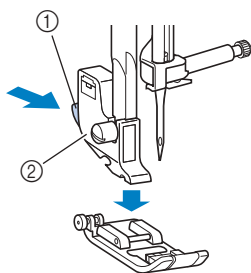

- ① Black button
- ② Presser foot holder

- 5 Place a different presser foot below the holder so that the presser foot pin is aligned with the notch in the holder.

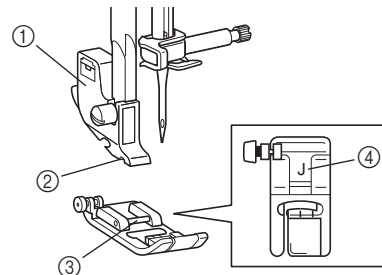

- ① Presser foot holder
- ② Notch
- ③ Pin
- ④ Presser foot type

- 6 Slowly lower the presser foot lever so that the presser foot pin snaps into the notch in the presser foot holder.

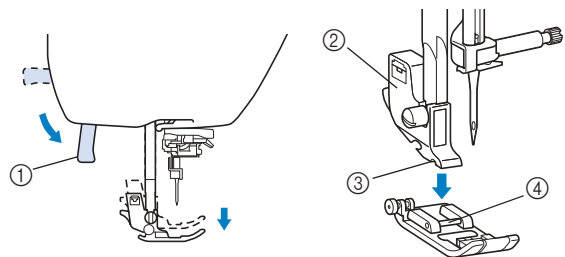

- ① Presser foot lever
- ② Presser foot holder
- ③ Notch
- ④ Pin
- The presser foot is attached.

- 7 Raise the presser foot lever to check that the presser foot is securely attached.

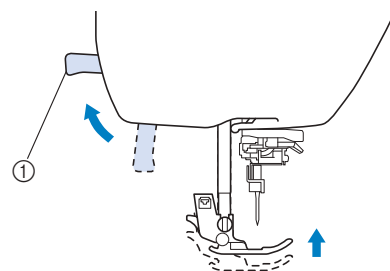







- ① Presser foot lever

- 8 Press to unlock all keys and buttons.

Note

- When a stitch is selected, the icon for the presser foot that should be used appears in the screen. Check that the correct presser foot is attached before starting to sew. If the wrong presser foot is installed, turn off the machine, attach the correct presser foot, turn machine back on and then select the desired stitch again.



-  Zigzag foot "J"
-  Monogramming foot "N"
-  Overcasting foot "G"
-  Buttonhole foot "A"
-  Blind stitch foot "R"
-  Button fitting foot "M"
-  Side cutter "S"

- For details on the presser foot that should be used with the selected stitch, refer to "Stitch Setting Chart" beginning on page B-47.

Removing and attaching the presser foot holder

Remove the presser foot holder when cleaning the machine or when installing a presser foot that does not use the presser foot holder, such as the walking foot and quilting foot. Use the screwdriver to remove the presser foot holder.

1 Remove the presser foot.

- For details, refer to "Replacing the presser foot" on page B-33.

2 Use the screwdriver to loosen the presser foot holder screw.

Turn the screw toward the back of the machine (counterclockwise).

- The presser foot holder screw can also be loosened or tightened with the L-shaped (or disc-shaped) screwdriver.

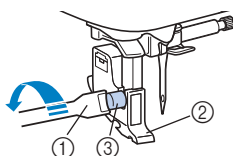

- ① Screwdriver
- ② Presser foot holder
- ③ Presser foot holder screw

Attaching the presser foot holder

1 Raise the presser foot lever.

2 Align the presser foot holder with the lower-left side of the presser bar.

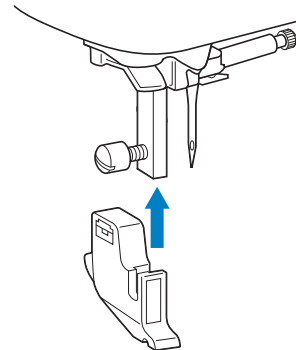

3 Hold the presser foot holder in place with your right hand, and then tighten the screw using the screwdriver in your left hand.

Turn the screw toward you (clockwise).

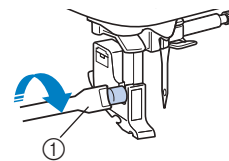

- ① Screwdriver

CAUTION

- Be sure to securely tighten the presser foot holder screw, otherwise the presser foot holder may fall off and the needle may strike it, causing the needle to bend or break.

Note

- If the presser foot holder is not correctly installed, the thread tension will be incorrect.

Chapter 2 STARTING TO SEW

Sewing

⚠ CAUTION

- While the machine is in operation, pay special attention to the needle location. In addition, keep your hands away from all moving parts such as the needle and handwheel, otherwise injuries may occur.
- Do not pull or push the fabric too hard while sewing, otherwise injuries may occur or the needle may break.
- Never use bent needles. Bent needles can easily break, possibly resulting in injuries.
- Make sure that the needle does not strike basting pins, otherwise the needle may break or bend.

Stitch types

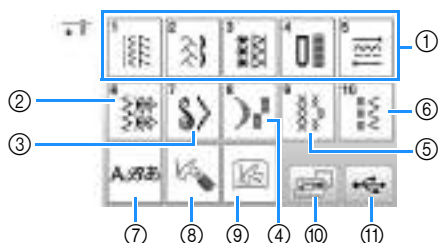

- ① Utility stitches
You can select from utility stitches, including straight line stitching, overcasting, buttonhole and basic decorative stitches.
For details on the various stitches, refer to "Stitch Setting Chart" beginning on page B-47.
 - ② Decorative stitches
 - ③ Satin stitches
 - ④ 7 mm satin stitches
 - ⑤ Cross stitch stitches
 - ⑥ Utility decorative stitches
 - ⑦ Character stitches
 - ⑧ MY CUSTOM STITCH
You can design original stitches. For details, refer to "Designing a Stitch" in the "Decorative sewing" section.
 - ⑨ MY CUSTOM STITCH stored in the machine's memory or USB flash drive
MY CUSTOM STITCH recalled from machine's memory or USB flash drive can be sewn.
 - ⑩ Patterns stored in the machine's memory
Patterns recalled from machine's memory can be sewn.
 - ⑪ Patterns stored in USB flash drive
Patterns recalled from the USB flash drive can be sewn.
- For details on sewing and storing the stitches ② through ⑪, refer to "Decorative sewing" section.

Sewing a stitch

- 1 Turn the main power to ON and press \uparrow (Needle position button) to raise the needle.

→ The screen of appears. If you want to sew any stitch in category, proceed to step 4.

- 2 Press on the operation panel.

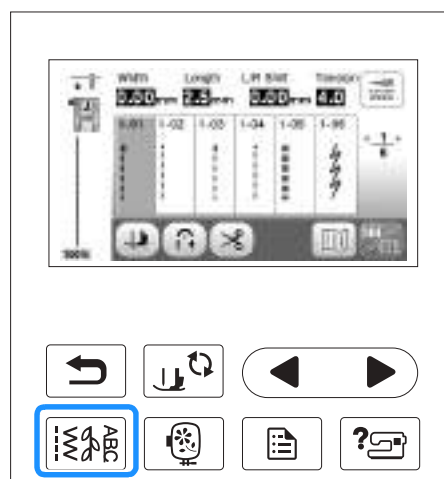

- 3 Select the stitch type.

- 4 Press the stitch selection.

\leftarrow displays the previous screen, and \rightarrow displays the next screen.

- For details on the key functions, refer to "Viewing the LCD" on page B-11.

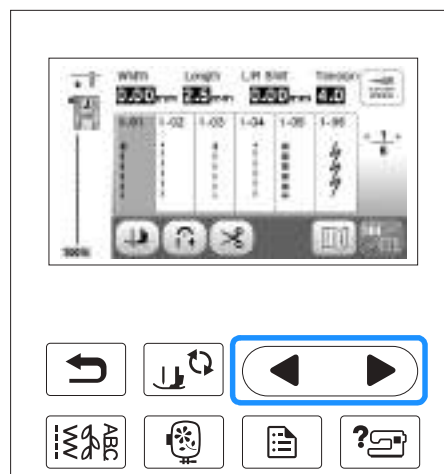

5 If necessary, specify the setting for automatic reverse/reinforcement stitching and adjust the stitch length, etc.

- For details on adjusting the stitch width and length, refer to “Setting the stitch width” on page B-40 and “Setting the stitch length” on page B-40.

Note

- When a stitch is selected, the icon for the presser foot that should be used appears on the screen. Check that the correct presser foot is attached before starting to sew. If the wrong presser foot is installed, turn off the machine, attach the correct presser foot, turn machine back on and then select the desired stitch again.

6 Install the presser foot.

- For details on changing the presser foot, refer to “Replacing the presser foot” on page B-33.

CAUTION

- Always use the correct presser foot. If the wrong presser foot is used, the needle may strike the presser foot and bend or break, possibly resulting in injury. Refer to page B-47 for presser foot recommendations.

7 Set the fabric under the presser foot. Hold the fabric and thread with your left hand, and rotate the handwheel counterclockwise or press \ominus (Needle position button) to set the needle in the sewing start position.

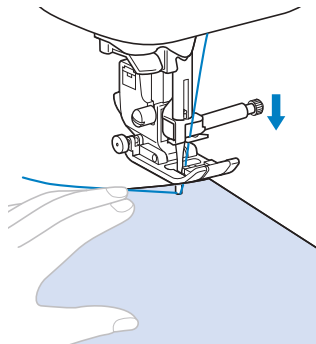

Memo

- The black button on the left side of presser foot “J” should be pressed only if the fabric does not feed or when sewing thick seams. For details, refer to “Sewing thick fabrics” in the “Sewing” section. Normally, you can sew without pressing the black button.

8 Lower the presser foot.

You do not have to pull up the bobbin thread.

9 Adjust the sewing speed with the sewing speed controller.

You can use this controller to adjust sewing speed during sewing.

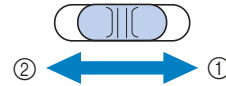

- ① Fast
- ② Slow

10 Press the “Start/Stop” button to start sewing. Guide the fabric lightly by hand.

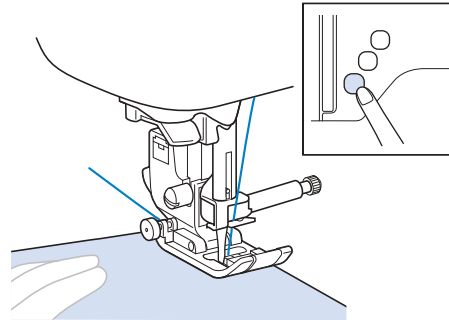

Memo

- When the foot controller is being used, you cannot start sewing by pressing the “Start/Stop” button.

11 Press the “Start/Stop” button again to stop sewing.

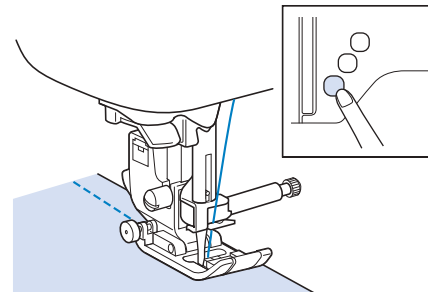

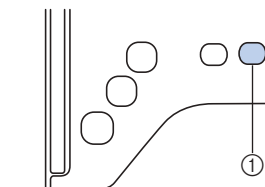

12 Press \otimes (Thread cutter button) to trim the upper and lower threads.



- ① Thread cutter button
- The needle will return to the up position automatically.

⚠ CAUTION

- Do not press  (Thread cutter button) after the threads have been cut. Doing so could tangle the thread or break the needle and damage the machine.
- Do not press  (Thread cutter button) when there is no fabric set in the machine or during machine operation. The thread may tangle, possibly resulting in damage.



Note

- When cutting thread such as nylon monofilament thread, or other decorative threads, use the thread cutter on the side of the machine.

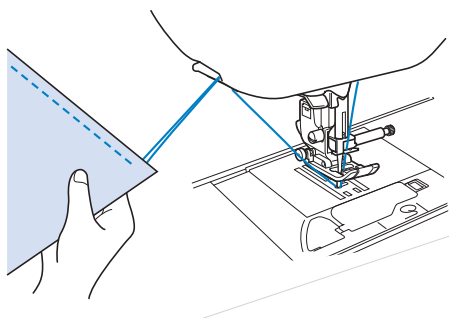

- 13** When the needle has stopped moving, raise the presser foot and remove the fabric.



Memo

- This machine is equipped with a bobbin thread sensor that warns you when the bobbin thread is almost empty. When the bobbin thread is nearly empty, the machine automatically stops. However, if the “Start/Stop” button is pressed, a few stitches can be sewn. When the warning displays, replace with a wound bobbin immediately.

■ Using the foot controller

You can also use the foot controller to start and stop sewing.

⚠ CAUTION

- Do not allow fabric pieces and dust to collect in the foot controller. Doing so could cause a fire or an electric shock.



Memo

- When the foot controller is being used, you cannot start sewing by pressing the “Start/Stop” button.
- Bobbin winding can be started and stopped with the foot controller.
- The foot controller cannot be used when embroidering.

- 1** Turn off the machine.

- 2** Insert the foot controller plug into its jack on the machine.

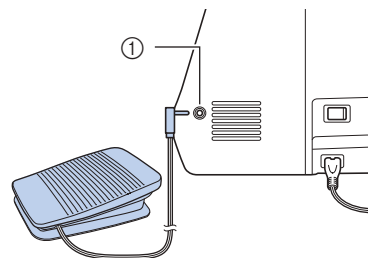

- ① Foot controller jack

- 3** Turn on the machine.

- 4** Slowly depress the foot controller to start sewing.

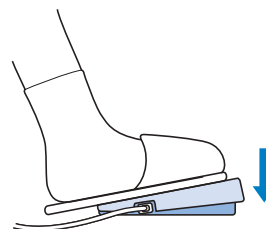

Memo

- The speed that is set using the sewing speed controller will be the foot controller’s maximum sewing speed.

- 5** Release the foot controller to stop the machine.



Sewing reinforcement stitches

Reverse/reinforcement stitches are generally necessary at the beginning and end of sewing. You can use  (Reverse stitch button) to sew reverse/reinforcement stitches. Refer to “Stitch Setting Chart” under the column for “Reverse/ Reinforcement stitching” on page B-47.

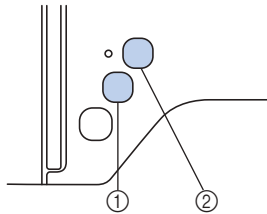
While pressing , the machine will sew 3 to 5 reinforcement stitches at that point and then stop.



- ① Reverse stitch button
- ② Reinforcement stitch button

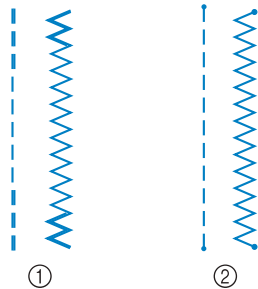

If the automatic reinforcement stitch is selected on the screen, reverse stitches (or reinforcement stitches) will be sewn automatically at the beginning of sewing when the “Start/ Stop” button is pressed. Press  (Reverse stitch button) or  (Reinforcement stitch button) to sew reverse stitches or reinforcement stitches automatically at the end of sewing.



- ① Reverse stitch
- ② Reinforcement stitch

The operation performed when the button is pressed differs depending on the selected pattern. Refer to the table in “Automatic reinforcement stitching” on page B-38.

Memo

- While pressing  (Reinforcement stitch button) when sewing character/decorative stitch pattern, you can end sewing with a completed motif instead of at the midpoint of a stitch motif.
- The green light on the left of  (Reinforcement stitch button) lights up while the machine is sewing a full motif, and it automatically turns off when the sewing is stopped.

Automatic reinforcement stitching

After selecting a stitch motif, turn on the automatic reinforcement stitching function before sewing, and the machine will automatically sew reinforcement stitches (or reverse stitches, depending on the stitch motif) at the beginning and end of sewing. Refer to the table on page B-39.

- 1 Select a stitch pattern.
- 2 Press  to set the automatic reinforcement stitching function.

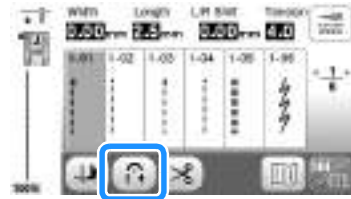

→ The key will display as .

Memo

- Some stitches, such as buttonholes and bar tacks, require reinforcement stitches at the beginning of sewing. If you select one of these stitches, the machine will automatically turn on this function (the key appears as  when the stitch is selected).

- 3 Set the fabric in the start position and begin sewing.

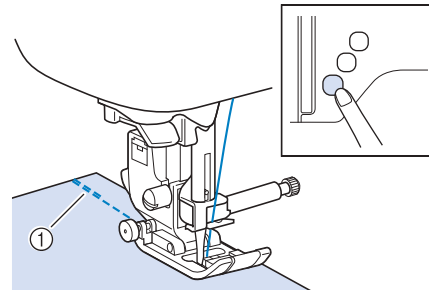



- ① Reverse stitches (or reinforcement stitches)
→ The machine will automatically sew reverse stitches (or reinforcement stitches) and then continue sewing.

Memo

- When selecting the stitches below, the machine will automatically sew reverse stitches at the beginning of the stitch.



- If you press the “Start/Stop” button to pause sewing, press it again to continue. The machine will not sew reverse/reinforcement stitches again.

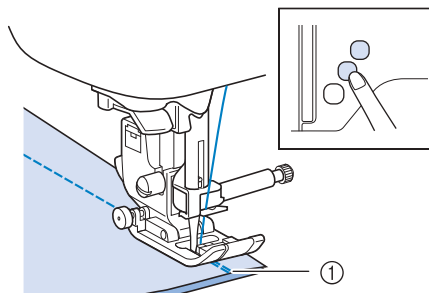

4 Press  (Reverse stitch button) or  (Reinforcement stitch button).









① Reverse stitches (or reinforcement stitches)
 → The machine will sew reverse stitches (or reinforcement stitches) and stop.





Memo

- To turn off the automatic reinforcement stitching function, press  again, so it appears as .

The operation performed when the button is pressed differs depending on the selected pattern. Refer to the following table for details on the operation that is performed when the button is pressed.

| | Reverse stitch button  | Reinforcement stitch button  |
|---|---|---|
| When the automatic reinforcement stitching function is not active while selecting utility stitches like examples shown below  | Machine starts sewing the stitches and only sews reverse stitches while holding the Reverse stitch button. | Machine starts sewing the stitches and sews 3 - 5 reinforcement stitches while holding the Reinforcement stitch button. |
| When the automatic reinforcement stitching function is not active while selecting utility stitches like examples shown below  | Machine starts sewing the stitches and only sews reverse stitches while holding the Reverse stitch button.* | Machine starts sewing the stitches and sews 3 - 5 reinforcement stitches while holding the Reinforcement stitch button. |
| When the automatic reinforcement stitching function is active while selecting utility stitches like examples shown below  | Machine sews reverse stitches at the beginning and end of sewing. | Machine sews reverse stitches at the beginning and reinforcement stitches at the end of sewing. |
| When the automatic reinforcement stitching function is active while selecting utility stitches like examples shown below  | Machine sews reinforcement stitches at the beginning and reverse stitches at the end of sewing.* | Machine sews reinforcement stitches at the beginning and end of sewing. |

| | Reverse stitch button  | Reinforcement stitch button  |
|---|---|--|
| When the automatic reinforcement stitching function is not active while selecting character/decorative stitches | Machine starts sewing and then sews reinforcement stitches while holding the Reverse stitch button. | Machine starts sewing at the beginning, then completes the pattern and sews reinforcement stitches at the end of sewing. |
| When the automatic reinforcement stitching function is active while selecting character/decorative stitches | Machine sews reinforcement stitches at the beginning and sews reinforcement stitches when the Reverse stitch button is pressed. | Machine sews reinforcement stitches at the beginning, then completes the pattern and sews reinforcement stitches at the end of sewing. |

* If "Reinforcement Priority" on page 3 of the settings screen is set to "ON", reinforcement stitches are sewn instead of reverse stitches.

Setting the Stitch

This machine is preset with the default settings for the stitch width, stitch length, “L/R Shift”, and upper thread tension for each stitch. However, you can change any of the settings by pressing  in the utility stitch screen, then following the procedure described in this section.



After changing the settings, press  to return to the utility stitch screen.



Note

- Stitch settings return to their defaults if they are changed, when the machine is turned off or a different stitch is selected before the stitch setting is saved, refer to “Saving stitch settings” on page B-42.

Setting the stitch width

The stitch width (zigzag width) can be adjusted to make the stitch wider or narrower.



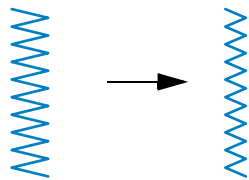

Each press of  makes the zigzag stitch narrower.

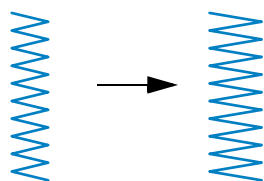

Each press of  makes the zigzag stitch wider.



Memo

- Press  to return the setting to its default.
- If the straight stitch (left needle position or triple stretch stitch) was selected, changing the stitch width changes the needle position. Increasing the width moves the needle to the right; reducing the width moves the needle to the left.
-  means the setting cannot be adjusted.

CAUTION

- After adjusting the stitch width, slowly turn the handwheel toward you (counterclockwise) and check that the needle does not touch the presser foot. If the needle hits the presser foot, the needle may bend or break.

Setting the stitch length

The stitch length can be adjusted to make the stitch coarser (longer) or finer (shorter).



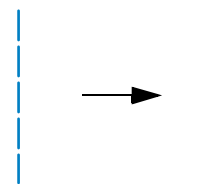

Each press of  makes the stitch finer (shorter).

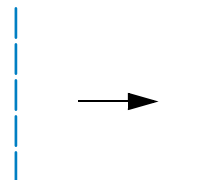

Each press of  makes the stitch coarser (longer).



Memo

- Press  to return the setting to its default.
-  means the setting cannot be adjusted.

Setting the "L/R Shift"

Follow the steps below when you want to change the placement of the zigzag stitch pattern by moving it left and right.



Press **-** to shift the pattern to the left.

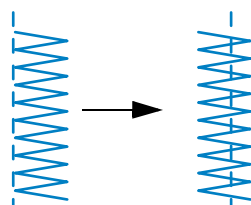

→ The value in the display appears with a minus sign.

Press **+** to shift the pattern to the right side of the left needle position.

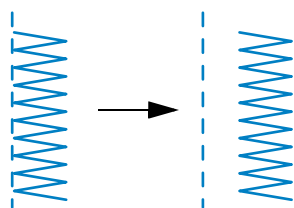

→ The value in the display appears with a plus sign.



Memo

- Press **0** to return the setting to its default.
- **-** means the setting cannot be adjusted.

CAUTION

- After adjusting the "L/R Shift", slowly rotate the handwheel toward you (counterclockwise) and check that the needle does not touch the presser foot. If the needle hits the presser foot, the needle may bend or break.
- If the stitches are bunched together, increase the stitch length. Continuing to sew with the stitches bunched together may result in the needle bending or breaking.

Setting the thread tension

You may need to change the thread tension, depending on the fabric and thread being used.



Correct thread tension

The upper thread and the bobbin thread should cross near the center of the fabric. Only the upper thread should be visible from the right side of the fabric, and only the bobbin thread should be visible from the wrong side of the fabric.

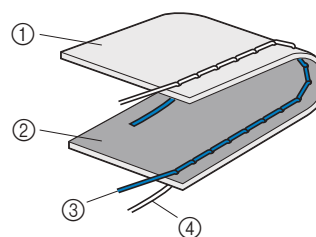

- ① Wrong side of fabric
- ② Right side of fabric
- ③ Upper thread
- ④ Bobbin thread

Upper thread is too tight

If the bobbin thread is visible from the right side of the fabric, the upper thread is too tight.



Note

- If the bobbin thread was incorrectly threaded, the upper thread may be too tight. In this case, refer to "Installing the bobbin" on page B-21 and rethread the bobbin thread.

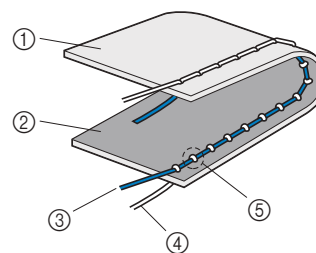

- ① Wrong side of fabric
- ② Right side of fabric
- ③ Upper thread
- ④ Bobbin thread
- ⑤ The bobbin thread is visible from the right side of the fabric.

Each press of **-** makes the thread tension looser.

Upper thread is too loose

If the upper thread is visible from the wrong side of the fabric, the upper thread is too loose.

Note

- If the upper thread was incorrectly threaded, the upper thread may be too loose. In this case, refer to “Upper Threading” on page B-24 and rethread the upper thread.

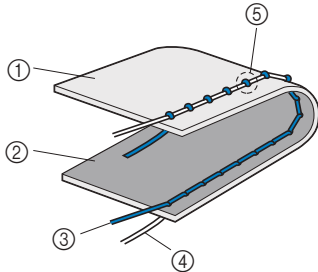

- ① Wrong side of fabric
- ② Right side of fabric
- ③ Upper thread
- ④ Bobbin thread
- ⑤ The upper thread is visible from the wrong side of the fabric.

Each press of makes the thread tension tighter.

Note

- If the upper thread is not threaded correctly or the bobbin is not installed correctly, it may not be possible to set the correct thread tension. If the correct thread tension cannot be achieved, rethread the upper thread and insert the bobbin correctly.

Saving stitch settings

If you wish to save specific settings for a stitch so that they can be used later, press after changing the settings to save the new settings with the selected stitch.

This feature can be used only with utility stitches.

- To use a stitch length of 2.0 mm for the straight stitch

- 1** Select a straight stitch.
- 2** Press .
- 3** Set the stitch length to 2.0 mm.



- 4** Press .

- To reset the selected stitch pattern back to its default settings, press , and then press .

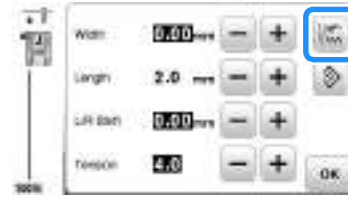

- 5** Press .

→ The original screen is displayed.

Note

- The next time that the same straight stitch is selected, the stitch length is set to 2.0 mm.
- All stitch settings (stitch width (zigzag width), stitch length, L/R shift, thread tension) are saved, not just the setting that was changed. When the same stitch pattern is selected, the last settings saved are displayed even if the machine was turned off. If the settings are changed again, or if is pressed to reset the setting to its default, the new settings are not saved unless is pressed another time. Even if is pressed, the settings for programmed thread cutting and automatic reverse/reinforcement stitching cannot be reset.



Useful Functions

Automatically cutting the thread

The machine can be set to automatically cut the threads at the end of the stitching. This is called “programmed thread-cutting”. If programmed thread-cutting is set, automatic reverse/reinforcement stitching is also set.

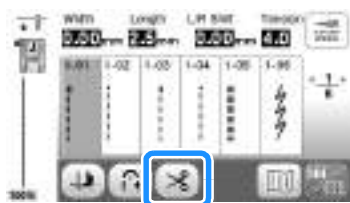
- 1 Turn on the machine.
- 2 Select a stitch.
 - For details on selecting a stitch, refer to “Sewing a stitch” on page B-35.
- 3 Press  on the screen.





→ You get  , and the machine is set for programmed thread-cutting and automatic reverse/reinforcement stitching.

- To turn programmed thread cutting off, press .

- 4 Set the fabric in place, and press the “Start/Stop” button once.

→ Stitching will begin after reverse stitches or reinforcement stitches are sewn.

- 5 Once you have reached the end of the stitching, press  (Reverse stitch button) or  (Reinforcement stitch button) once.

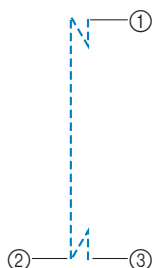

If stitching, such as buttonholes and bar tacking, that includes reinforcement stitching has been selected, this operation is unnecessary.

→ After the reverse stitching or reinforcement stitching has been done, the machine stops, and the thread is cut.





- ① The point where the “Start/Stop” button was pressed.
- ② The point where  (Reverse stitch button) or  (Reinforcement stitch button) was pressed.
- ③ The thread is cut here.

Memo

- Programmed thread-cutting will not be performed if the “Start/Stop” button is pressed while sewing. Press  (Reverse stitch button) or  (Reinforcement stitch button) at the end of the stitching.
- If the power is turned off, programmed thread-cutting will be turned off.

Mirroring stitches

You can sew the mirror image of a stitch horizontally (left and right).

- 1 Turn on the machine.
- 2 Select a stitch.
 - For details on selecting a stitch, refer to “Sewing a stitch” on page B-35.
- 3 Press , and then  on the screen.



→ It turns to , and the pattern displayed at the top of the screen is mirrored.

- To turn the mirrored stitching off, press .

Memo

- Mirroring is not possible when the mirroring icon is grayed out on the editing screen. Certain stitches, such as buttonholes, etc., cannot be mirrored.
- When the machine is turned off, the mirroring setting is cancelled.

Adjusting the presser foot pressure

You can adjust the presser foot pressure (the amount of pressure applied to the fabric by the presser foot) on the settings screen. The higher the number, the greater the pressure will be. Set the pressure at “3” for normal sewing.

- 1 Press  to display the settings screen.
- 2 Display page 2.

- 3 Adjust the “Presser Foot Pressure” by pressing / .



Automatic Fabric Sensor System (Automatic presser foot pressure)

The thickness of the fabric is automatically detected and the presser foot pressure is automatically adjusted with an internal sensor while sewing, to insure that your fabric is fed smoothly. The fabric sensor system works continuously while sewing. This function is useful for sewing over thick seams or quilting. For details, refer to the “Sewing” section.

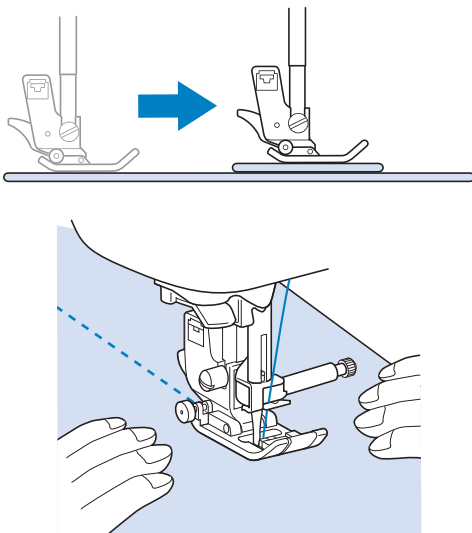

- 1 Press to display the settings screen.
- 2 Display page 3.
- 3 Set “Automatic Fabric Sensor System” to “ON”.

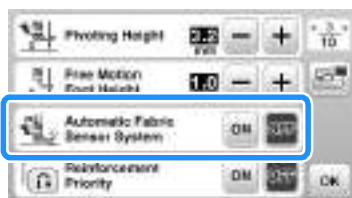

- 4 Press to return to the original screen.

Pivoting

If the pivot key is selected, the machine stops with the needle lowered (in the fabric) and the presser foot is automatically raised to an appropriate height when the “Start/Stop” button is pressed. When the “Start/Stop” button is pressed again, the presser foot is automatically lowered and sewing continues. This function is useful for stopping the machine to rotate the fabric.

⚠ CAUTION

- When the pivot key is selected, the machine will begin stitching when the “Start/Stop” button is pressed or the foot controller is pressed down even if the presser foot has been raised by pressing (Presser foot lifter button). Be sure to keep your hands and other items away from the needle, otherwise injuries may occur.

Memo

- When the pivot key is selected, the height of the presser foot when sewing is stopped can be changed according to the type of fabric being sewn. Press to display “Pivoting Height” in the settings screen. Press or to select one of the three heights (3.2 mm, 5.0 mm or 7.5 mm). Generally 3.2 mm is the preferred setting.



Note

- The “Needle Position - Up / Down” in the settings screen, must be set to the down position for the pivot function to be used. When “Needle Position - Up / Down” is set in the raised position, appears as light gray and cannot be used.
- The pivot function can only be used with stitches where presser foot J or N is indicated in the upper-left corner of the screen. If any other stitch is selected, appears as light gray and is not available.
- Use (Presser foot lifter button) to make sure the presser foot is lowered, and then press the “Start/Stop” button to continue sewing.
- If the pivot key is selected, and beside “Presser Foot Height” in the settings screen are not available and the setting cannot be changed.

1 Select a stitch.

2 Press  to select the pivot function.

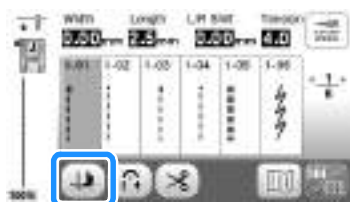

→ The key appears as .

3 Place the fabric under the presser foot with the needle at the starting point of the stitching, lower presser foot and then press the "Start/Stop" button. The machine will begin sewing.

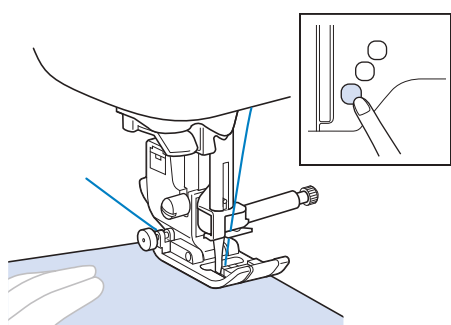

Memo

- If you press the "Start/Stop" button to pause sewing, press it again to continue, reverse stitches (or reinforcement stitches) will not be sewn.

4 Press the "Start/Stop" button to stop the machine at the point where the sewing direction changes.

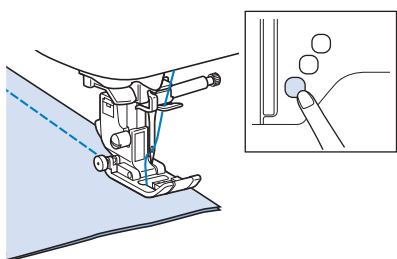

→ The machine stops with the needle in the fabric, and the presser foot is raised.

5 Rotate the fabric, and then press the "Start/Stop" button.

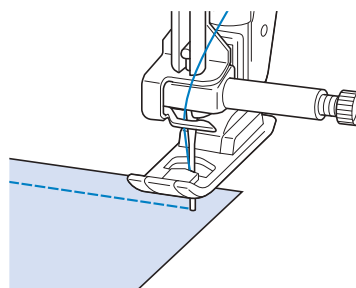

→ The presser foot is automatically lowered, and sewing continues.

Sewing with free motion mode

In free motion mode, the presser foot is raised to the necessary height for free motion sewing. When starting to sew, the internal sensor detects the thickness of the fabric, and the quilting foot is raised to the height specified in the machine settings screen.

In this mode, lower the feed dogs (using the feed dog position switch) so that the fabric can be moved freely in any direction.

CAUTION

- With free motion quilting, control the feeding speed of the fabric to match the sewing speed. If the fabric is moved faster than the sewing speed, the needle may break or other damage may result.

■ Adjusting free motion presser foot height

1 Select a stitch.

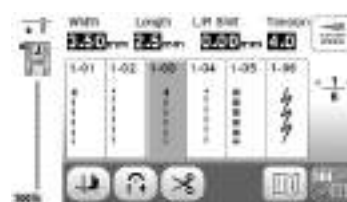



2 Press  to display editing screen.

3 Press .



→ The key appears as .

4 Press  to display the settings screen.

- 5 Display page 3.
- 6 Adjust the “Free Motion Foot Height” by pressing  /  to select the height that the quilting foot is raised above the fabric.

- Increase the setting by pressing , for example, when sewing very stretchy fabric, so that it is easier to sew.



 **Memo**

- In order to sew with a balanced tension, it may be necessary to adjust the upper thread tension. For details, refer to “Setting the thread tension” on page B-41. Test with a sample piece of quilting fabric.

Hands-free raising and lifting of the presser foot

Using the knee lifter, you can raise and lower the presser foot with your knee, leaving both hands free to handle the fabric.



■ Installing the knee lifter

- 1 Turn off the machine.
- 2 Insert the knee lifter into the mounting slot on the front of the machine in the lower-right corner.

Align the tabs on the knee lifter with the notches in the mounting slot, and then insert the knee lifter as far as possible.

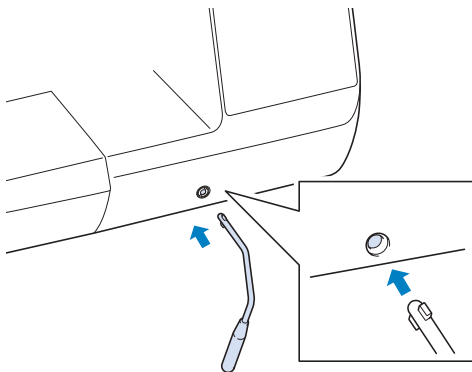

 **Note**

- If the knee lifter is not fully inserted into the mounting slot, it may fall out while the machine is operating.

■ Using the knee lifter

- 1 Stop the machine.
 - Do not use the knee lifter while the machine is operating.
- 2 With your knee, press the knee lifter to the right. Keep the knee lifter pressed to the right.

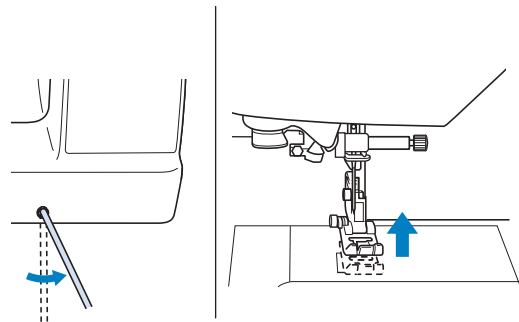

→ The presser foot is raised.

- 3 Release the knee lifter.

→ The presser foot is lowered.

CAUTION

- While sewing, keep your knee away from the knee lifter. If the knee lifter is pressed while the machine is operating, the needle may break or the machine may be damaged.

Stitch Setting Chart

Applications, stitch lengths and widths and whether the twin needle can be used are listed for utility stitches in the following table.



Memo

- The stitches shown in the table below may differ slightly from the stitch patterns displayed in the LCD.

- *1 For free motion quilting, use free motion open toe quilting foot "O".
- *2 For free motion quilting, use free motion quilting foot "C" (sold separately with some models) or free motion open toe quilting foot "O".
- *3 When the Automatic reverse/reinforcement key is activated, the stitch will begin with reinforcement stitch. If "Reinforcement Priority" on page 3 of the settings screen is also set to "ON", the machine will sew reinforcement stitches at the end of stitching and then stop.



Note

- Do not sew reverse stitching when using the walking foot.

| Stitch | Stitch number | Stitch name | Presser foot | Applications | Stitch width [mm (inch)] | | Twin needle | Reverse/Reinforcement stitching | Walking foot |
|--------|---------------|--------------------------------------|--------------|---|--|---|-------------|---------------------------------|--------------|
| | | | | | Auto. | Manual | | | |
| | 1-01 | Straight stitch (Left) | J*1 | General sewing, gather, pintuck, etc. | 0.0 (0) 0.0 - 7.0 (0 - 1/4) | 2.5 (3/32) 0.2 - 5.0 (1/64 - 3/16) | OK (J) | Reverse | NO |
| | 1-02 | Straight stitch (Left) | J*1 | General sewing, gather, pintuck, etc. | 0.0 (0) 0.0 - 7.0 (0 - 1/4) | 2.5 (3/32) 0.2 - 5.0 (1/64 - 3/16) | OK (J) | Reverse*3 | OK |
| | 1-03 | Straight stitch (Middle) | J*1 | General sewing, gather, pintuck, etc. | 3.5 (1/8) 0.0 - 7.0 (0 - 1/4) | 2.5 (3/32) 0.2 - 5.0 (1/64 - 3/16) | OK (J) | Reverse | NO |
| | 1-04 | Straight stitch (Middle) | J*1 | General sewing, gather, pintuck, etc. | 3.5 (1/8) 0.0 - 7.0 (0 - 1/4) | 2.5 (3/32) 0.2 - 5.0 (1/64 - 3/16) | OK (J) | Reinforcement | NO |
| | 1-05 | Triple stretch stitch | J*1 | General sewing for reinforcement and decorative topstitching | 0.0 (0) 0.0 - 7.0 (0 - 1/4) | 2.5 (3/32) 0.4 - 5.0 (1/64 - 3/16) | OK (J) | Reinforcement | NO |
| | 1-06 | Stem stitch | J*1 | Reinforced stitching, sewing and decorative applications | 1.0 (1/16) 0.0 - 7.0 (0 - 1/4) | 2.5 (3/32) 0.4 - 5.0 (1/64 - 3/16) | OK (J) | Reinforcement | NO |
| | 1-07 | Decorative stitch | N*1 | Decorative stitching, top stitching | 0.0 (0) 0.0 - 7.0 (0 - 1/4) | 2.5 (3/32) 0.4 - 5.0 (1/64 - 3/16) | OK (J) | Reinforcement | NO |
| | 1-08 | Basting stitch | J*1 | Basting | 0.0 (0) 0.0 - 7.0 (0 - 1/4) | 20 (3/4) 5 - 30 (3/16 - 1-3/16) | NO | Reinforcement | NO |
| | 1-09 | Zigzag stitch | J*1 | For overcasting, mending. | 3.5 (1/8) 0.0 - 7.0 (0 - 1/4) | 1.4 (1/16) 0.0 - 5.0 (0 - 3/16) | OK (J) | Reverse | NO |
| | 1-10 | Zigzag stitch | J*1 | For overcasting, mending. | 3.5 (1/8) 0.0 - 7.0 (0 - 1/4) | 1.4 (1/16) 0.0 - 5.0 (0 - 3/16) | OK (J) | Reverse*3 | NO |
| | 1-11 | Zigzag stitch (Right) | J*1 | Start from right needle position, zigzag sew at left. | 3.5 (1/8) 2.5 - 5.0 (3/32 - 3/16) | 1.4 (1/16) 0.3 - 5.0 (1/64 - 3/16) | OK (J) | Reverse*3 | OK |
| | 1-12 | Zigzag stitch (Left) | J*1 | Start from left needle position, zigzag sew at right. | 3.5 (1/8) 2.5 - 5.0 (3/32 - 3/16) | 1.4 (1/16) 0.3 - 5.0 (1/64 - 3/16) | OK (J) | Reverse*3 | NO |
| | 1-13 | 2 steps elastic zigzag stitch | J*1 | Overcasting (medium weight and stretch fabrics), tape and elastic | 5.0 (3/16) 0.0 - 7.0 (0 - 1/4) | 1.0 (1/16) 0.2 - 5.0 (1/64 - 3/16) | OK (J) | Reverse*3 | OK |
| | 1-14 | 3 steps elastic zigzag stitch | J*1 | Overcasting (medium, heavyweight and stretch fabrics), tape and elastic | 5.0 (3/16) 0.0 - 7.0 (0 - 1/4) | 1.0 (1/16) 0.2 - 5.0 (1/64 - 3/16) | OK (J) | Reverse*3 | NO |

| Stitch | Stitch number | Stitch name | Presser foot | Applications | Stitch width [mm (inch)] | Stitch length [mm (inch)] | Twin needle | Reverse/Reinforcement stitching | Walking foot |
|--------|---------------|---------------------------------|--------------|--|---|---|-------------|---------------------------------|--------------|
| | | | | | Auto. Manual | Auto. Manual | | | |
| | 1-15 | Overcasting stitch | G | Reinforcing of light and medium weight fabrics | 3.5 (1/8) 2.5 - 5.0 (3/32 - 3/16) | 2.0 (1/16) 0.4 - 5.0 (1/64 - 3/16) | NO | Reinforcement | NO |
| | 1-16 | Overcasting stitch | G | Reinforcing of heavyweight fabric | 5.0 (3/16) 2.5 - 5.0 (3/32 - 3/16) | 2.5 (3/32) 0.4 - 5.0 (1/64 - 3/16) | NO | Reinforcement | NO |
| | 1-17 | Overcasting stitch | G | Reinforcing of medium, heavyweight and easily friable fabrics or decorative stitching. | 5.0 (3/16) 3.5 - 5.0 (1/8 - 3/16) | 2.5 (3/32) 0.4 - 5.0 (1/64 - 3/16) | NO | Reinforcement | NO |
| | 1-18 | Overcasting stitch | J*1 | Reinforced seaming of stretch fabric | 5.0 (3/16) 0.0 - 7.0 (0 - 1/4) | 2.5 (3/32) 0.4 - 5.0 (1/64 - 3/16) | OK (J) | Reinforcement | NO |
| | 1-19 | Overcasting stitch | J*1 | Reinforcing of medium stretch fabric and heavyweight fabric, decorative stitching | 5.0 (3/16) 0.0 - 7.0 (0 - 1/4) | 2.5 (3/32) 0.4 - 5.0 (1/64 - 3/16) | OK (J) | Reinforcement | NO |
| | 1-20 | Overcasting stitch | J*1 | Reinforcement of stretch fabric or decorative stitching | 4.0 (3/16) 0.0 - 7.0 (0 - 1/4) | 4.0 (3/16) 0.4 - 5.0 (1/64 - 3/16) | OK (J) | Reinforcement | NO |
| | 1-21 | Overcasting stitch | J*1 | Stretch knit seam | 5.0 (3/16) 0.0 - 7.0 (0 - 1/4) | 4.0 (3/16) 0.4 - 5.0 (1/64 - 3/16) | NO | Reinforcement | NO |
| | 1-22 | Single diamond overcast stitch | J*1 | Reinforcement and seaming stretch fabric | 6.0 (15/64) 0.0 - 7.0 (0 - 1/4) | 3.0 (1/8) 0.4 - 5.0 (1/64 - 3/16) | OK (J) | Reinforcement | NO |
| | 1-23 | Single diamond overcast stitch | J*1 | Reinforcement of stretch fabric | 6.0 (15/64) 0.0 - 7.0 (0 - 1/4) | 1.8 (1/16) 0.4 - 5.0 (1/64 - 3/16) | OK (J) | Reinforcement | NO |
| | 1-24 | With side cutter | S | Straight stitch while cutting fabrics | 0.0 (0) 0.0 - 2.5 (0 - 3/32) | 2.5 (3/32) 0.2 - 5.0 (1/64 - 3/16) | NO | Reinforcement | NO |
| | 1-25 | With side cutter | S | Zigzag stitch while cutting fabrics | 3.5 (1/8) 3.5 - 5.0 (1/8 - 3/16) | 1.4 (1/16) 0.0 - 5.0 (0 - 3/16) | NO | Reinforcement | NO |
| | 1-26 | With side cutter | S | Overcasting stitch while cutting fabrics | 3.5 (1/8) 3.5 - 5.0 (1/8 - 3/16) | 2.0 (1/16) 0.4 - 5.0 (1/64 - 3/16) | NO | Reinforcement | NO |
| | 1-27 | With side cutter | S | Overcasting stitch while cutting fabrics | 5.0 (3/16) 3.5 - 5.0 (1/8 - 3/16) | 2.5 (3/32) 0.4 - 5.0 (1/64 - 3/16) | NO | Reinforcement | NO |
| | 1-28 | With side cutter | S | Overcasting stitch while cutting fabrics | 5.0 (3/16) 3.5 - 5.0 (1/8 - 3/16) | 2.5 (3/32) 0.4 - 5.0 (1/64 - 3/16) | NO | Reinforcement | NO |
| | 1-29 | Piecing stitch (Right) | J*1 | Piecework/patchwork 6.5 mm (approx. 1/4 inch) right seam allowance | 5.5 (7/32) 0.0 - 7.0 (0 - 1/4) | 2.0 (1/16) 0.2 - 5.0 (1/64 - 3/16) | NO | Reverse*3 | NO |
| | 1-30 | Piecing stitch (Middle) | J*2 | Piecework/patchwork | — | 2.0 (1/16) 0.2 - 5.0 (1/64 - 3/16) | NO | Reverse*3 | NO |
| | 1-31 | Piecing stitch (Left) | J*1 | Piecework/patchwork 6.5 mm (approx. 1/4 inch) left seam allowance | 1.5 (1/16) 0.0 - 7.0 (0 - 1/4) | 2.0 (1/16) 0.2 - 5.0 (1/64 - 3/16) | NO | Reverse*3 | OK |
| | 1-32 | Hand-look quilting stitch | J*1 | Quilting stitch made to look like hand quilting stitch | 0.0 (0) 0.0 - 7.0 (0 - 1/4) | 2.5 (3/32) 0.4 - 5.0 (1/64 - 3/16) | NO | Reinforcement | NO |
| | 1-33 | Quilting appliqué zigzag stitch | J*1 | Zigzag stitch for quilting and sewing on appliqué quilt pieces | 3.5 (1/8) 0.0 - 7.0 (0 - 1/4) | 1.4 (1/16) 0.0 - 5.0 (0 - 3/16) | NO | Reverse*3 | OK |
| | 1-34 | Quilting appliqué stitch | J*1 | Quilting stitch for invisible appliqué or attaching binding | 1.5 (1/16) 0.0 - 7.0 (0 - 1/4) | 1.8 (1/16) 0.4 - 5.0 (1/64 - 3/16) | NO | Reinforcement | NO |
| | 1-35 | Quilting stippling stitch | J*1 | Background quilting | 7.0 (1/4) 0.0 - 7.0 (0 - 1/4) | 1.6 (1/16) 0.4 - 5.0 (1/64 - 3/16) | NO | Reinforcement | NO |
| | 2-01 | Blind hem stitch | R | Hemming woven fabrics | 00 3← →3 | 2.0 (1/16) 0.4 - 5.0 (1/64 - 3/16) | NO | Reinforcement | NO |

| Stitch | Stitch number | Stitch name | Presser foot | Applications | Stitch width [mm (inch)] | Stitch length [mm (inch)] | Twin needle | Reverse/Reinforcement stitching | Walking foot |
|---|---------------|---|-----------------|---|--|---|-------------|---------------------------------|--------------|
| | | | | | Auto. Manual | Auto. Manual | | | |
|  | 2-02 | Blind hem stretch stitch | R | Hemming stretch fabric | 00 3← -- →3 | 2.0 (1/16) 0.4 - 5.0 (1/64 - 3/16) | NO | Reinforcement | NO |
|  | 2-03 | Blanket stitch | J | Appliqués, decorative blanket stitch | 3.5 (1/8) 0.0 - 7.0 (0 - 1/4) | 2.5 (3/32) 0.4 - 5.0 (1/64 - 3/16) | OK (J) | Reinforcement | NO |
|  | 2-04 | Shell tuck edge stitch | J* ¹ | Shell tuck edge finish on fabrics | 4.0 (3/16) 0.0 - 7.0 (0 - 1/4) | 2.5 (3/32) 0.2 - 5.0 (1/64 - 3/16) | OK (J) | Reinforcement | NO |
|  | 2-05 | Satin scallop stitch | N* ¹ | Decorating collar of blouse, edge of handkerchief | 5.0 (3/16) 0.0 - 7.0 (0 - 1/4) | 0.5 (1/32) 0.1 - 5.0 (1/64 - 3/16) | OK (J) | Reinforcement | NO |
|  | 2-06 | Scallop stitch | N* ¹ | Decorating collar of blouse, edge of handkerchief | 7.0 (1/4) 0.0 - 7.0 (0 - 1/4) | 1.4 (1/16) 0.4 - 5.0 (1/64 - 3/16) | NO | Reinforcement | NO |
|  | 2-07 | Patchwork join stitch | J* ¹ | Patchwork stitches, decorative stitching | 4.0 (3/16) 0.0 - 7.0 (0 - 1/4) | 1.2 (1/16) 0.2 - 5.0 (1/64 - 3/16) | OK (J) | Reinforcement | NO |
|  | 2-08 | Patchwork double overlock stitch | J* ¹ | Patchwork stitches, decorative stitching | 5.0 (3/16) 0.0 - 7.0 (0 - 1/4) | 2.5 (3/32) 0.4 - 5.0 (1/64 - 3/16) | OK (J) | Reinforcement | NO |
|  | 2-09 | Couching stitch | J* ¹ | Decorative stitching, attaching cord and couching | 5.0 (3/16) 0.0 - 7.0 (0 - 1/4) | 1.2 (1/16) 0.2 - 5.0 (1/64 - 3/16) | OK (J) | Reinforcement | NO |
|  | 2-10 | Smocking stitch | J* ¹ | Smocking, decorative stitching | 5.0 (3/16) 0.0 - 7.0 (0 - 1/4) | 1.6 (1/16) 0.4 - 5.0 (1/64 - 3/16) | OK (J) | Reinforcement | NO |
|  | 2-11 | Feather stitch | J* ¹ | Fagoting, decorative stitching | 5.0 (3/16) 0.0 - 7.0 (0 - 1/4) | 2.5 (3/32) 0.4 - 5.0 (1/64 - 3/16) | OK (J) | Reinforcement | NO |
|  | 2-12 | Fagoting cross stitch | J* ¹ | Fagoting, bridging and decorative stitching | 5.0 (3/16) 0.0 - 7.0 (0 - 1/4) | 2.5 (3/32) 0.4 - 5.0 (1/64 - 3/16) | OK (J) | Reinforcement | NO |
|  | 2-13 | Tape attaching stitch | J* ¹ | Attaching tape to seam in stretch fabric | 4.0 (3/16) 0.0 - 7.0 (0 - 1/4) | 1.0 (1/16) 0.2 - 5.0 (1/64 - 3/16) | OK (J) | Reinforcement | NO |
|  | 2-14 | Ladder stitch | J* ¹ | Decorative stitching | 4.0 (3/16) 0.0 - 7.0 (0 - 1/4) | 3.0 (1/8) 0.4 - 5.0 (1/64 - 3/16) | NO | Reinforcement | NO |
|  | 2-15 | Rick-rack stitch | J* ¹ | Decorative top stitching | 4.0 (3/16) 0.0 - 7.0 (0 - 1/4) | 2.5 (3/32) 0.4 - 5.0 (1/64 - 3/16) | OK (J) | Reinforcement | NO |
|  | 2-16 | Decorative stitch | J* ¹ | Decorative stitching | 5.5 (7/32) 0.0 - 7.0 (0 - 1/4) | 1.6 (1/16) 0.4 - 5.0 (1/64 - 3/16) | OK (J) | Reinforcement | NO |
|  | 2-17 | Serpentine stitch | N* ¹ | Decorative stitching and attaching elastic | 5.0 (3/16) 0.0 - 7.0 (0 - 1/4) | 1.0 (1/16) 0.2 - 5.0 (1/64 - 3/16) | OK (J) | Reinforcement | NO |
|  | 2-18 | Decorative stitch | N* ¹ | Decorative stitching and appliqué | 6.0 (15/64) 0.0 - 7.0 (0 - 1/4) | 1.0 (1/16) 0.2 - 5.0 (1/64 - 3/16) | OK (J) | Reinforcement | NO |
|  | 2-19 | Decorative stippling stitch | N* ¹ | Decorative stitching | 7.0 (1/4) 0.0 - 7.0 (0 - 1/4) | 1.6 (1/16) 0.4 - 5.0 (1/64 - 3/16) | NO | Reinforcement | NO |
|  | 3-01 | Hemstitching | N* ¹ | Decorative hems, triple straight at left | 1.0 (1/16) 0.0 - 7.0 (0 - 1/4) | 2.5 (3/32) 0.4 - 5.0 (1/64 - 3/16) | OK (J) | Reinforcement | NO |
|  | 3-02 | Hemstitching | N* ¹ | Decorative hems, triple straight at center | 3.5 (1/8) 0.0 - 7.0 (0 - 1/4) | 2.5 (3/32) 0.4 - 5.0 (1/64 - 3/16) | OK (J) | Reinforcement | NO |
|  | 3-03 | Hemstitching zigzag | N* ¹ | Decorative hems, top stitching | 6.0 (15/64) 0.0 - 7.0 (0 - 1/4) | 3.0 (1/8) 0.4 - 5.0 (1/64 - 3/16) | OK (J) | Reinforcement | NO |
|  | 3-04 | Hemstitching | N* ¹ | Decorative hems, lace attaching pin stitch | 3.5 (1/8) 0.0 - 7.0 (0 - 1/4) | 2.5 (3/32) 0.4 - 5.0 (1/64 - 3/16) | NO | Reinforcement | NO |

| Stitch | Stitch number | Stitch name | Presser foot | Applications | Stitch width [mm (inch)] | Stitch length [mm (inch)] | Twin needle | Reverse/Reinforcement stitching | Walking foot |
|--------|---------------|--|--------------|---|--|---|-------------|---------------------------------|--------------|
| | | | | | Auto. Manual | Auto. Manual | | | |
| | 3-05 | Hemstitching | N*1 | Decorative hems | 3.0 (1/8) 0.0 - 7.0 (0 - 1/4) | 3.5 (1/8) 0.4 - 5.0 (1/64 - 3/16) | NO | Reinforcement | NO |
| | 3-06 | Hemstitching | N*1 | Decorative hems, daisy stitch | 6.0 (15/64) 0.0 - 7.0 (0 - 1/4) | 3.0 (1/8) 0.4 - 5.0 (1/64 - 3/16) | NO | Reinforcement | NO |
| | 3-07 | Hemstitching | N*1 | Heirloom, decorative hems | 5.0 (3/16) 0.0 - 7.0 (0 - 1/4) | 3.5 (1/8) 0.4 - 5.0 (1/64 - 3/16) | NO | Reinforcement | NO |
| | 3-08 | Hemstitching | N*1 | Heirloom, decorative hems | 5.0 (3/16) 0.0 - 7.0 (0 - 1/4) | 3.5 (1/8) 0.4 - 5.0 (1/64 - 3/16) | NO | Reinforcement | NO |
| | 3-09 | Hemstitching | N*1 | Heirloom, decorative hems | 5.0 (3/16) 0.0 - 7.0 (0 - 1/4) | 3.5 (1/8) 0.4 - 5.0 (1/64 - 3/16) | OK (J) | Reinforcement | NO |
| | 3-10 | Hemstitching | N*1 | Heirloom, decorative hems | 5.0 (3/16) 0.0 - 7.0 (0 - 1/4) | 4.0 (3/16) 0.4 - 5.0 (1/64 - 3/16) | OK (J) | Reinforcement | NO |
| | 3-11 | Hemstitching | N*1 | Heirloom, decorative hems | 4.0 (3/16) 0.0 - 7.0 (0 - 1/4) | 2.5 (3/32) 0.4 - 5.0 (1/64 - 3/16) | OK (J) | Reinforcement | NO |
| | 3-12 | Honeycomb stitch | N*1 | Heirloom, decorative hems | 5.0 (3/16) 0.0 - 7.0 (0 - 1/4) | 2.5 (3/32) 0.4 - 5.0 (1/64 - 3/16) | OK (J) | Reinforcement | NO |
| | 3-13 | Honeycomb stitch | N*1 | Heirloom, decorative hems | 6.0 (15/64) 0.0 - 7.0 (0 - 1/4) | 3.5 (1/8) 0.4 - 5.0 (1/64 - 3/16) | OK (J) | Reinforcement | NO |
| | 3-14 | Hemstitching | N*1 | Heirloom, decorative hems | 6.0 (15/64) 0.0 - 7.0 (0 - 1/4) | 1.6 (1/16) 0.4 - 5.0 (1/64 - 3/16) | OK (J) | Reinforcement | NO |
| | 3-15 | Hemstitching | N*1 | Heirloom, decorative hems | 6.0 (15/64) 0.0 - 7.0 (0 - 1/4) | 3.0 (1/8) 0.4 - 5.0 (1/64 - 3/16) | NO | Reinforcement | NO |
| | 3-16 | Hemstitching | N*1 | Heirloom, decorative hems | 6.0 (15/64) 0.0 - 7.0 (0 - 1/4) | 4.0 (3/16) 0.4 - 5.0 (1/64 - 3/16) | OK (J) | Reinforcement | NO |
| | 3-17 | Hemstitching | N*1 | Heirloom, decorative hems | 4.0 (3/16) 0.0 - 7.0 (0 - 1/4) | 2.5 (3/32) 0.4 - 5.0 (1/64 - 3/16) | NO | Reinforcement | NO |
| | 3-18 | Hemstitching | N*1 | Heirloom, decorative hems | 5.0 (3/16) 0.0 - 7.0 (0 - 1/4) | 2.0 (1/16) 0.4 - 5.0 (1/64 - 3/16) | OK (J) | Reinforcement | NO |
| | 3-19 | Hemstitching | N*1 | Decorative hems and bridging stitch | 6.0 (15/64) 0.0 - 7.0 (0 - 1/4) | 2.0 (1/16) 0.4 - 5.0 (1/64 - 3/16) | OK (J) | Reinforcement | NO |
| | 3-20 | Hemstitching | N*1 | Decorative hems. Fagoting, attaching ribbon | 5.0 (3/16) 0.0 - 7.0 (0 - 1/4) | 3.0 (1/8) 0.4 - 5.0 (1/64 - 3/16) | OK (J) | Reinforcement | NO |
| | 3-21 | Hemstitching | N*1 | Decorative hems, smocking | 6.0 (15/64) 0.0 - 7.0 (0 - 1/4) | 1.6 (1/16) 0.4 - 5.0 (1/64 - 3/16) | NO | Reinforcement | NO |
| | 3-22 | Hemstitching | N*1 | Decorative hems, smocking | 5.0 (3/16) 0.0 - 7.0 (0 - 1/4) | 1.6 (1/16) 0.4 - 5.0 (1/64 - 3/16) | NO | Reinforcement | NO |
| | 4-01 | Narrow rounded buttonhole stitch | A | Buttonhole on light to medium weight fabrics | 5.0 (3/16) 3.0 - 5.0 (1/8 - 3/16) | 0.4 (1/64) 0.2 - 1.0 (1/64 - 1/16) | NO | Automatic reinforcement | NO |
| | 4-02 | Tapered round ended buttonhole stitch | A | Reinforced waist tapered buttonholes | 5.0 (3/16) 3.0 - 5.0 (1/8 - 3/16) | 0.4 (1/64) 0.2 - 1.0 (1/64 - 1/16) | NO | Automatic reinforcement | NO |
| | 4-03 | Round ended buttonhole stitch | A | Buttonholes with vertical bar tack in heavyweight fabrics | 5.0 (3/16) 3.0 - 5.0 (1/8 - 3/16) | 0.4 (1/64) 0.2 - 1.0 (1/64 - 1/16) | NO | Automatic reinforcement | NO |

| Stitch | Stitch number | Stitch name | Presser foot | Applications | Stitch width [mm (inch)] | Stitch length [mm (inch)] | Twin needle | Reverse/Reinforcement stitching | Walking foot |
|---|---------------|--|--------------|--|---|---|-------------|---------------------------------|--------------|
| | | | | | Auto. Manual | Auto. Manual | | | |
|  | 4-04 | Narrow squared buttonhole stitch | A | Buttonholes for light to medium weight fabrics | 5.0 (3/16) 3.0 - 5.0 (1/8 - 3/16) | 0.4 (1/64) 0.2 - 1.0 (1/64 - 1/16) | NO | Automatic reinforcement | NO |
|  | 4-05 | Stretch buttonhole stitch | A | Buttonholes for stretch or woven fabrics | 6.0 (15/64) 3.0 - 6.0 (1/8 - 15/64) | 1.0 (1/16) 0.5 - 2.0 (1/32 - 1/16) | NO | Automatic reinforcement | NO |
|  | 4-06 | Heirloom buttonhole stitch | A | Buttonholes for heirloom and stretch fabrics | 6.0 (15/64) 3.0 - 6.0 (1/8 - 15/64) | 1.5 (1/16) 1.0 - 3.0 (1/16 - 1/8) | NO | Automatic reinforcement | NO |
|  | 4-07 | Bound buttonhole stitch | A | The first step in making bound buttonholes | 5.0 (3/16) 0.0 - 6.0 (0 - 15/64) | 2.0 (1/16) 0.2 - 4.0 (1/64 - 3/16) | NO | Automatic reinforcement | NO |
|  | 4-08 | Keyhole buttonhole stitch | A | Buttonholes in heavyweight or thick fabrics for larger flat buttons | 7.0 (1/4) 3.0 - 7.0 (1/8 - 1/4) | 0.5 (1/32) 0.3 - 1.0 (1/64 - 1/16) | NO | Automatic reinforcement | NO |
|  | 4-09 | Tapered keyhole buttonhole stitch | A | Buttonholes in medium to heavy weight fabrics for larger flat buttons | 7.0 (1/4) 3.0 - 7.0 (1/8 - 1/4) | 0.5 (1/32) 0.3 - 1.0 (1/64 - 1/16) | NO | Automatic reinforcement | NO |
|  | 4-10 | Keyhole buttonhole stitch | A | Buttonholes with vertical bar tack for reinforcement in heavyweight or thick fabrics | 7.0 (1/4) 3.0 - 7.0 (1/8 - 1/4) | 0.5 (1/32) 0.3 - 1.0 (1/64 - 1/16) | NO | Automatic reinforcement | NO |
|  | 4-11 | Darning stitch | A | Darning of medium weight fabric | 7.0 (1/4) 2.5 - 7.0 (3/32 - 1/4) | 2.0 (1/16) 0.4 - 2.5 (1/64 - 3/32) | NO | Automatic reinforcement | NO |
|  | 4-12 | Darning stitch | A | Darning of heavyweight fabric | 7.0 (1/4) 2.5 - 7.0 (3/32 - 1/4) | 2.0 (1/16) 0.4 - 2.5 (1/64 - 3/32) | NO | Automatic reinforcement | NO |
|  | 4-13 | Bar tack stitch | A | Reinforcement at opening of pocket, etc. | 2.0 (1/16) 1.0 - 3.0 (1/16 - 1/8) | 0.4 (1/64) 0.3 - 1.0 (1/64 - 1/16) | NO | Automatic reinforcement | NO |
|  | 4-14 | Button sewing stitch | M | Attaching buttons | 3.5 (1/8) 2.5 - 4.5 (3/32 - 3/16) | — | NO | Automatic reinforcement | NO |
|  | 4-15 | Eyelet stitch | N | For making eyelets, holes on belts, etc. | 7.0 (1/4) 7.0 6.0 5.0 (1/4 15/64 3/16) | 7.0 (1/4) 7.0 6.0 5.0 (1/4 15/64 3/16) | NO | Automatic reinforcement | NO |
|  | 5-01 | Reverse (Straight) stitch | N | For attaching appliqué on tubular pieces of fabric and mitering corners | — | — | NO | Reinforcement | NO |
|  | 5-02 | Sideways to left (Straight) stitch | N | For attaching appliqué on tubular pieces of fabric | — | — | NO | Reinforcement | NO |
|  | 5-03 | Sideways to right (Straight) stitch | N | For attaching appliqué on tubular pieces of fabric | — | — | NO | Reinforcement | NO |
|  | 5-04 | Forward (Straight) stitch | N | For attaching appliqué on tubular pieces of fabric and mitering corners | — | — | NO | Reinforcement | NO |
|  | 5-05 | Sideways to left (Zigzag) stitch | N | For attaching appliqué on tubular pieces of fabric | — | — | NO | Reinforcement | NO |
|  | 5-06 | Sideways to right (Zigzag) stitch | N | For attaching appliqué on tubular pieces of fabric | — | — | NO | Reinforcement | NO |
|  | 5-07 | Forward (Zigzag) stitch | N | For attaching appliqué on tubular pieces of fabric and mitering corners | — | — | NO | Reinforcement | NO |
|  | 5-08 | Reverse (Zigzag) stitch | N | For attaching appliqué on tubular pieces of fabric and mitering corners | — | — | NO | Reinforcement | NO |

Chapter 3 STARTING TO EMBROIDER

Embroidery Step by Step

Follow the steps below to prepare the machine for embroidery.

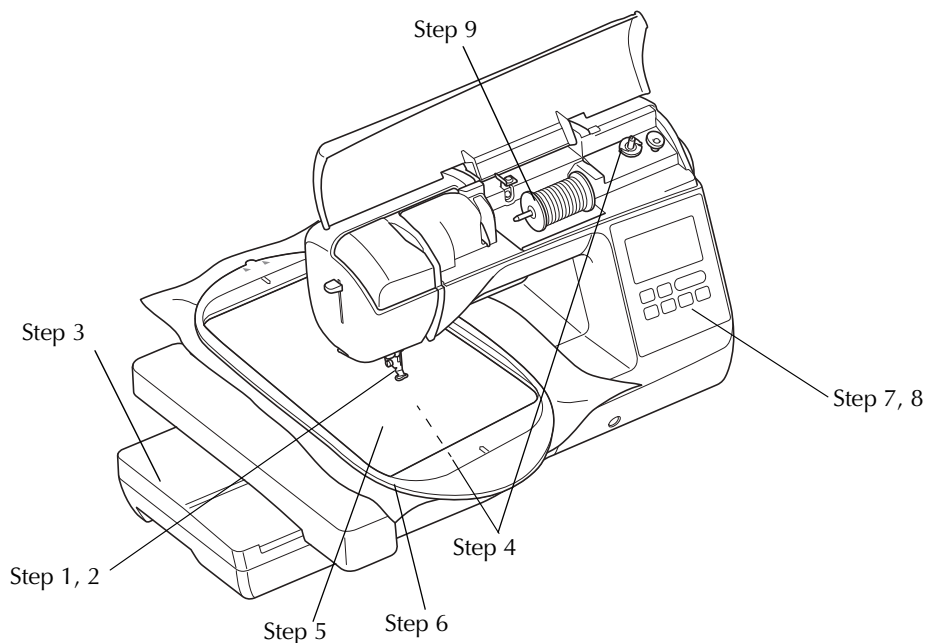

| Step # | Aim | Action | Page |
|--------|-----------------------------|--|------|
| 1 | Presser foot attachment | Attach embroidery foot "U". | B-53 |
| 2 | Checking the needle | Use needle 75/11 for embroidery. * | B-30 |
| 3 | Embroidery unit attachment | Attach the embroidery unit. | B-54 |
| 4 | Bobbin thread setup | For the bobbin thread, wind embroidery bobbin thread and set it in place. | B-21 |
| 5 | Fabric preparation | Attach a stabilizer material to the fabric, and hoop it in the embroidery frame. | B-57 |
| 6 | Embroidery frame attachment | Attach the embroidery frame to the embroidery unit. | B-63 |
| 7 | Pattern selection | Turn the main power to on, and select an embroidery pattern. | B-62 |
| 8 | Checking the layout | Check and adjust the size and position of the embroidery. | B-63 |
| 9 | Embroidery thread setup | Set up embroidery thread according to the pattern. | B-56 |

* It is recommended that a 90/14 needle should be used when embroidering on heavy weight fabrics or stabilizing products (for example; denim, puffy foam, etc.). Ball point needle (golden colored) 90/14 is not recommended for embroidery.

Attaching the Embroidery Foot

⚠ CAUTION

- Be sure to use embroidery foot when doing embroidery. Using another presser foot may cause the needle to strike the presser foot, causing the needle to bend or break and possibly cause injury.

1 Press  (Needle position button) to raise the needle.

2 Press .

- When the message "OK to automatically lower the presser foot?" appears on the LCD screen, press  to continue.

→ The screen changes, and all keys and operation buttons are locked (except .

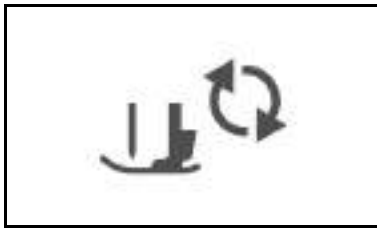

3 Raise the presser foot lever.

4 Press the black button on the presser foot holder to remove the presser foot.

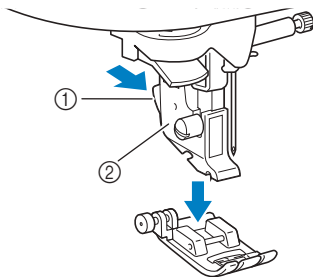

- ① Black button
- ② Presser foot holder

5 Use the included screwdriver to loosen the presser foot holder screw, and then remove the presser foot holder.

- The presser foot holder screw can also be loosened or tightened with the L-shaped (or disc-shaped) screwdriver.

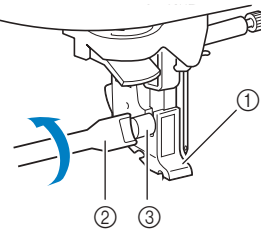

- ① Screwdriver
- ② Presser foot holder
- ③ Presser foot holder screw

6 Attach embroidery foot "U" so that the presser foot holder screw fits into the notch in the foot.

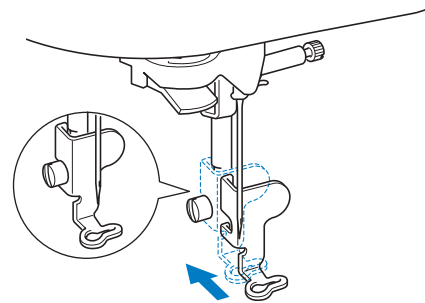

- Make sure that embroidery foot "U" is vertical when it is installed.

7 Hold the embroidery foot in place with your right hand, and then use the included screwdriver to securely tighten the presser foot holder screw.

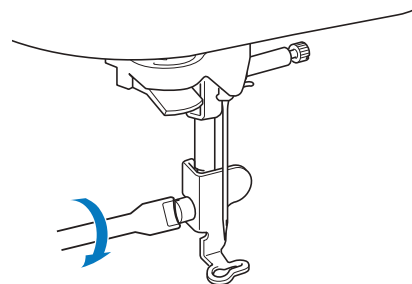

⚠ CAUTION

- Use the included screwdriver to firmly tighten the screw of the embroidery foot. If the screw is loose, the needle may strike the presser foot and possibly cause injury.

8 Press  to unlock all keys and buttons.

Attaching the Embroidery Unit

⚠ CAUTION

- Do not move the machine with the embroidery unit in place. The embroidery unit may be dropped and cause injury.
- Keep your hands and other objects away from the embroidery carriage and frame. Otherwise injury may result.



Note

- Do not touch the connector in the embroidery unit connector slot. The connector could be damaged, and it may cause malfunctions.
- Do not lift up on the embroidery carriage, and do not forcefully move it. It may cause malfunctions.

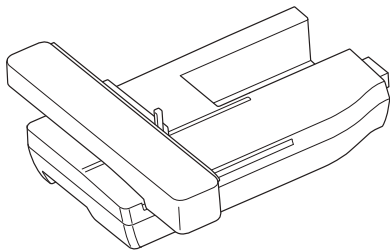
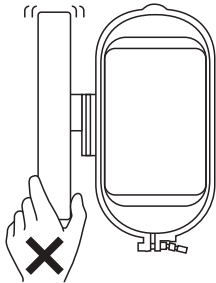

- 1 Turn off the machine.

⚠ CAUTION

- Before attaching the embroidery unit, be sure to turn off the machine. Otherwise, injuries may occur if one of the operation buttons is accidentally pressed and the machine starts sewing.

- 2 Pull the flat bed attachment off to the left.

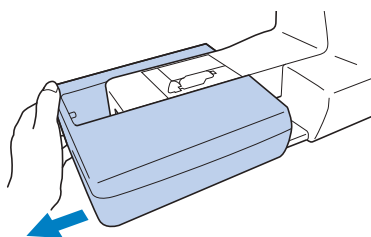

- 3 Slide the tab on the cover of the connection port in the direction of the arrow to open the cover.

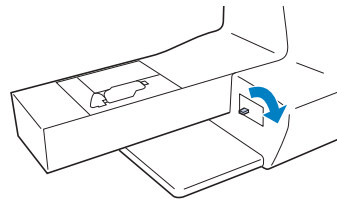

Note

- Be sure to close the cover of the connection port when the embroidery unit is not being used.

- 4 Insert the embroidery unit connector into the connection port, and then lightly push in the embroidery unit until it snaps into place.

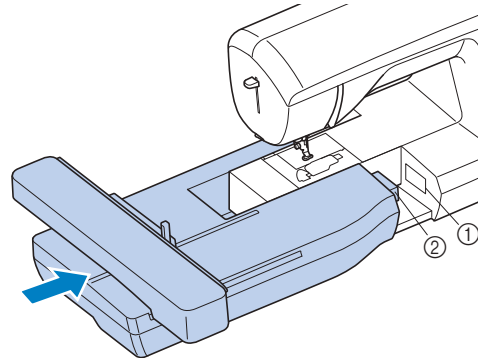

- ① Connection port
- ② Embroidery unit connector



Note

- Make sure that there is no gap between the embroidery unit and the machine, otherwise the embroidery pattern may not be sewn correctly. Be sure to fully insert the connector into the connection port.
- Do not push on the carriage when attaching the embroidery unit to the machine, otherwise damage to the embroidery unit may result.

- 5 Turn on the machine.

→ A message appears in the screen.

- 6 Be sure that no objects or hands are near the embroidery unit and press .



→ The carriage moves to its initial position.

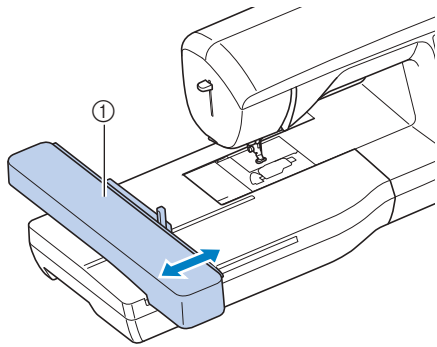

① Carriage

⚠ CAUTION

- Keep your hands and foreign objects away from the embroidery carriage and frame when the machine is embroidering. Otherwise, injury may result.

Note

- If the machine was not initialized correctly, the initial screen may not appear. This is not a sign of a malfunction. If this occurs, turn the machine off, then on again.
- A confirmation message to lower the frame-securing lever after the carriage moves to its initial position is displayed. Continue with pattern selection and remember to lower the frame-securing lever when the embroidery frame is attached.

→ The screen for selecting the embroidery pattern type is displayed.



- For details on the embroidery patterns, refer to "Selecting Embroidery Patterns" on page B-62.

Memo

- Utility stitches cannot be selected when the embroidery unit is attached.

■ Removing the embroidery unit

Make sure that the machine is completely stopped and follow the instructions below.

1 Remove the embroidery frame.

- For details on removing the embroidery frame, refer to "Attaching the Embroidery Frame" on page B-61.

2 Press , and then press .



→ The embroidery carriage moves into a position where it can be stored.

3 Turn off the machine.

⚠ CAUTION

- Always turn off the machine before removing the embroidery unit. It may cause malfunctions if removed when the machine is turned on.

4 Hold the release button on the bottom left of the embroidery unit, and slowly pull the embroidery unit to the left.

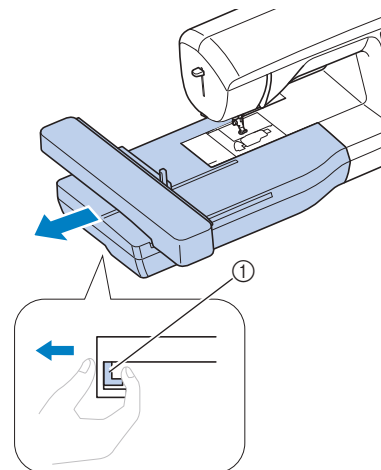

① Release button

⚠ CAUTION

- Do not carry the embroidery unit by holding the release button compartment.

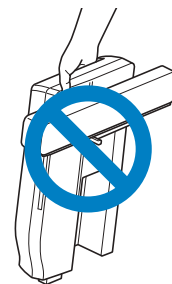

Embroidery Attractive Finishes

There are many factors that go into beautiful embroidery. Using the appropriate stabilizer (page B-57) and hooping the fabric in the frame (page B-58) are two important factors mentioned earlier. Another important point is the appropriateness of the needle and thread being used. See the explanation of threads below.

■ Thread

| | |
|----------------------|--|
| Upper thread | Use embroidery thread intended for use with this machine. Other embroidery threads may not yield optimum results. |
| Bobbin thread | Use embroidery bobbin thread intended for use with this machine. |

Note

- Before embroidering, check that there is enough thread in the bobbin. If you start to sew your embroidery project without enough thread in the bobbin, you will need to rewind the bobbin in the middle of the embroidery pattern.

Memo

- If you use threads other than those listed above, the embroidery may not sew out correctly.

■ Bobbin case

Two types of bobbin cases are included with this machine. When embroidering, use the appropriate bobbin case depending on the bobbin thread that will be used. See the explanation of bobbin case types below.

Standard bobbin case (recommended for sewing and for embroidering with included 60 weight bobbin thread)

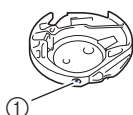

- ① Standard bobbin case
(green marking on the screw)

The standard bobbin case originally installed in the machine has a green marking on the tension adjustment screw. We recommend using the included embroidery bobbin thread with this bobbin case. Do not adjust the tension screw on this bobbin case with the green marked screw.

Alternate bobbin case (for prewound or other embroidery bobbin threads)

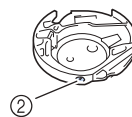

- ② Alternate bobbin case
(no color on the screw)

The alternate bobbin case with no color on the tension adjustment screw is set with tighter tension for embroidery with different weights of bobbin threads and a variety of embroidery techniques. This bobbin case is identified with a dark colored mark on the inside of the bobbin cavity. The tension screw on this case can be adjusted if necessary. For details on adjusting thread tension, refer to "Adjusting thread tension" in the "Embroidering" section.

- See "Cleaning the Race" in the "Appendix" section for how to remove the bobbin case.

⚠ CAUTION

- **When embroidering on large garments (especially jackets or other heavy fabrics), do not let the fabric hang over the table. Otherwise, the embroidery unit cannot move freely and the embroidery frame may strike the needle, causing the needle to bend or break and possibly cause injury. Place the fabric so that it does not hang off the table or hold the fabric to keep it from dragging.**

Note



- Do not leave objects in the range of motion of the embroidery frame. The frame may strike the object and cause a poor finish to the embroidery pattern.
- When embroidering on large garments (especially jackets or other heavy fabrics), do not let the fabric hang over the table. Otherwise, the embroidery unit cannot move freely, and the pattern may not turn out as planned.

Preparing the Fabric

⚠ CAUTION

- Use fabrics with a thickness of less than 3 mm (approx. 1/8 inch). Using fabrics thicker than 3 mm (approx. 1/8 inch) may cause the needle to break.
- When using layers with thicker batting etc., you can sew more attractive embroidery by adjusting the embroidery presser foot height in the embroidery settings screen (see below).
- In the case of thick terry cloth towels we recommend that you place a piece of water soluble stabilizer on the top surface of the towel. This will help to reduce the nap of the toweling and result in more attractive embroidery.

Note

- Press . In the "Embroidery Foot Height" display, use  and  in the settings screen. Adjust the presser foot height for thick or puffy fabrics.

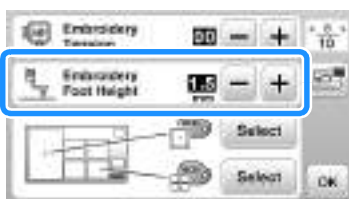

- To increase the space between the presser foot and the needle plate, set the embroidery foot height to a larger number, 1.5 mm setting is used for most embroidery.

Attaching iron-on stabilizers (backing) to the fabric

For best results in your embroidery projects, always use stabilizer material for embroidery. Follow the package instructions for the stabilizer being used.

When using fabrics that cannot be ironed (such as terry cloth or fabrics that have loops which expand when ironed) or in places where ironing is difficult, position the stabilizer material under the fabric without fusing it, then position the fabric and stabilizer in the embroidery frame, or check with your authorized Brother dealer for the correct stabilizer to use.

⚠ CAUTION

- Always use a stabilizer material for embroidery when sewing stretch fabrics, lightweight fabrics, fabrics with a coarse weave, or fabrics which cause pattern shrinkage. Otherwise, the needle may break and cause injury. Not using a stabilizer material may result in a poor finish to your project.

- 1 Use a piece of stabilizer which is larger than the embroidery frame being used.

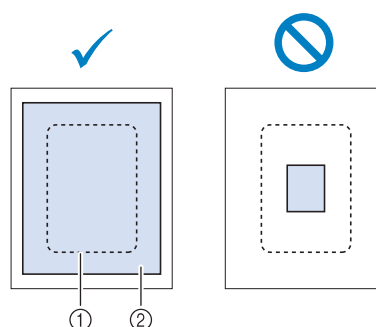

- ① Size of the embroidery frame
- ② Iron-on stabilizer (backing)

- 2 Iron the iron-on stabilizer material to the wrong side of the fabric.

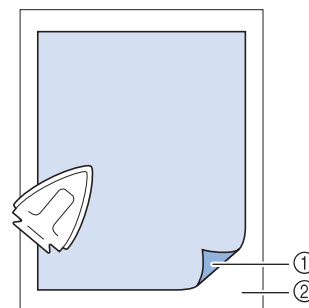

- ① Fusible side of stabilizer
- ② Fabric (wrong side)

Memo

- When embroidering on thin fabrics such as organdy or lawn, or on napped fabrics such as terry cloth or corduroy, use water soluble stabilizer (sold separately) for best results. The water soluble stabilizer material will dissolve completely in water, giving the project a more attractive finish.

Hooping the fabric in the embroidery frame

Types of embroidery frames

The types and numbers of supplied embroidery frames will differ depending on the machine model.

Extra Large

Embroidery field 26 cm × 16 cm
(10 - 1/4 inches × 6 - 1/4 inches)

Use when embroidering connected or combined characters or patterns, or when embroidering large patterns.

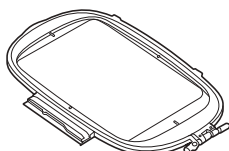

Large (sold separately with some models)

Embroidery field 18 cm × 13 cm (7 inches × 5 inches)
Use when embroidering patterns between 10 cm × 10 cm (4 inches × 4 inches) and 18 cm × 13 cm (7 inches × 5 inches).

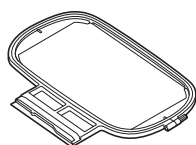

Medium (sold separately with some models)

Embroidery field 10 cm × 10 cm (4 inches × 4 inches)
Use when embroidering patterns under 10 cm × 10 cm (4 inches × 4 inches).

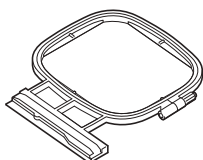

Small (sold separately with some models)

Embroidery field 2 cm × 6 cm (1 inch × 2 - 1/2 inches)
Use when embroidering small sized patterns, such as name tags.

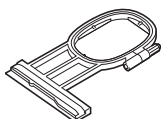

Other optional embroidery frames can be used. When choosing frames that do not appear on the screen, be sure to check the design size of the embroidery field of the optional frame. Check with your authorized Brother dealer for frame compatibility. Select a frame that is slightly larger than the pattern size. Included frame options are displayed on the screen.

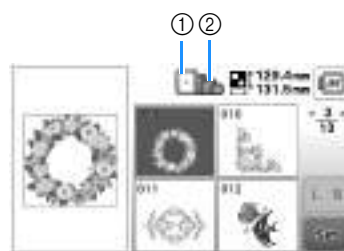

- ① Highlighted: Can be used
- ② Shaded: Cannot be used

CAUTION

- If you use a frame that is too small, the presser foot may strike the frame during sewing and cause injury or may damage your machine.

Inserting the Fabric



Note

- If the fabric is not securely held in the embroidery frame, the embroidery design will sew out poorly. Insert the fabric on a level surface, and gently stretch the fabric taut in the frame. Follow the steps below to insert the fabric correctly.

- 1 Lift-up and loosen the frame adjustment screw and remove the inner frame.

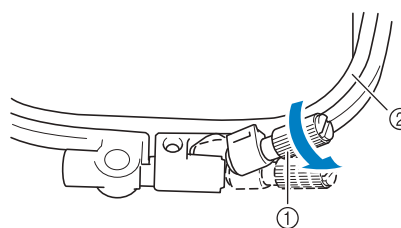

- ① Frame adjustment screw
- ② Inner frame

- 2** Lay the fabric right side up on top of the outer frame.
Re-insert the inner frame making sure to align the inner frame's \triangle with the outer frame's ∇ .

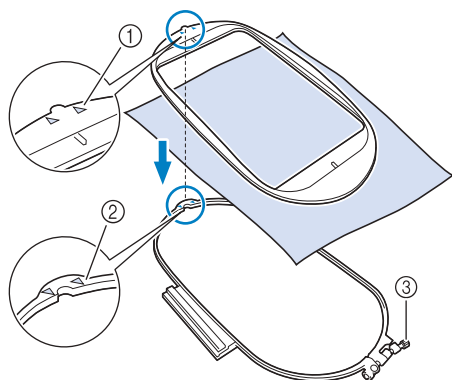

- ① Inner frame's \triangle
- ② Outer frame's ∇
- ③ Frame adjustment screw

- 3** Slightly tighten the frame adjustment screw, and then remove the slack in the fabric by gently pulling on the edges and corners. Do not loosen the screw.

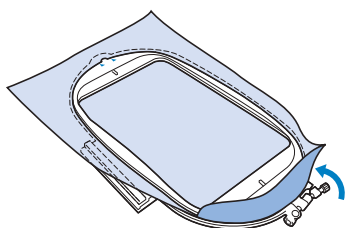

- 4** Gently stretch the fabric taut, and tighten the frame adjustment screw to keep the fabric from loosening after stretching.

- After stretching the fabric, make sure the fabric is taut.

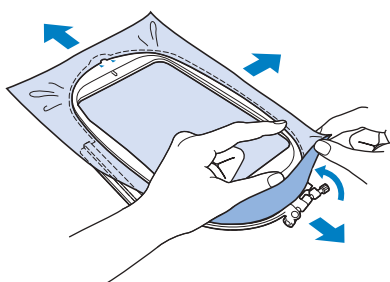

- Make sure the inside and outside frames are even before you start embroidering.

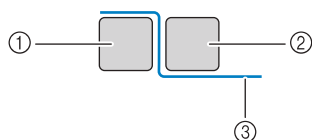

- ① Outer frame
- ② Inner frame
- ③ Fabric

Memo

- After stretching the fabric, lightly tapping it should produce a drum-like sound.
- Stretch the fabric from all four corners and all four edges. While stretching the fabric, tighten the frame adjustment screw.

- 5** Return the frame adjustment screw to its initial position.

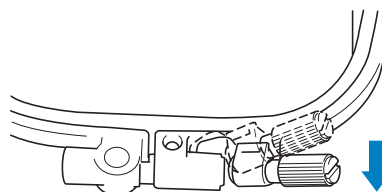

Memo

- You can use the included screwdriver when you loosen or tighten the frame adjustment screw.

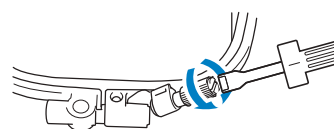

Using the embroidery sheet

When you want to embroider the pattern in a particular place, use the embroidery sheet with the frame.

- 1** With a chalk pencil, mark the area of the fabric you want to embroider.

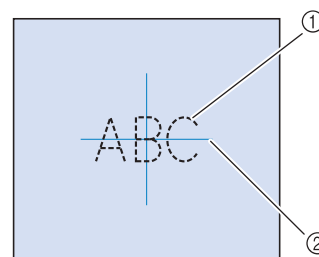

- ① Embroidery pattern
- ② Mark

- 2** Place the embroidery sheet on the inner frame. Align the guide lines on the embroidery sheet with the mark you made on the fabric.

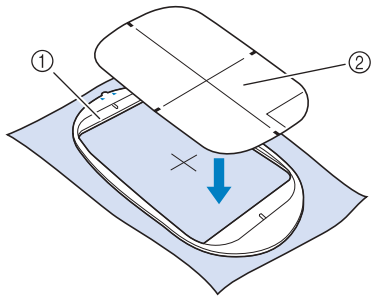

- ① Inner frame
- ② Guide line

- 3** Gently stretch the fabric so there are no folds or wrinkles, and press the inner frame into the outer frame.

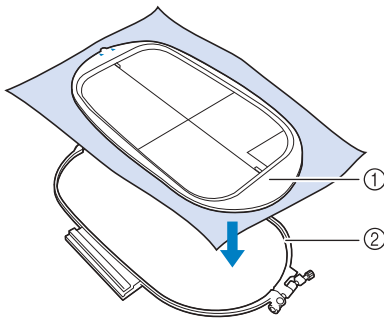

- ① Inner frame
- ② Outer frame

- 4** Remove the embroidery sheet.

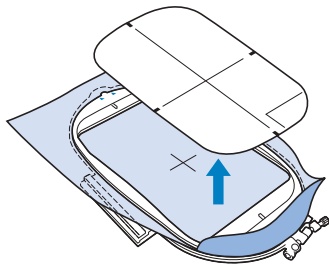

Embroidering small fabrics or fabric edges

Use an embroidery stabilizer to provide extra support. After embroidering, remove the stabilizer carefully. Attach the stabilizer as shown in the following examples. We recommend using a stabilizer for embroidery.

Embroidering small fabrics

Use a temporary spray adhesive to adhere the small piece of fabric to the larger piece in the frame. If you do not wish to use a temporary spray adhesive, attach the stabilizer with a basting stitch.

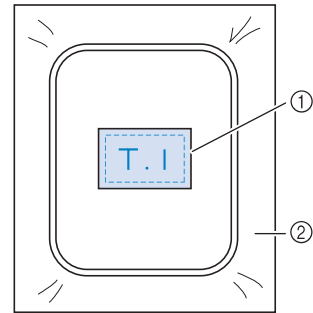

- ① Fabric
- ② Stabilizer

Embroidering edges or corners

Use a temporary spray adhesive to adhere the small piece of fabric to the larger piece in the frame. If you do not wish to use a temporary spray adhesive, attach the stabilizer with a basting stitch.

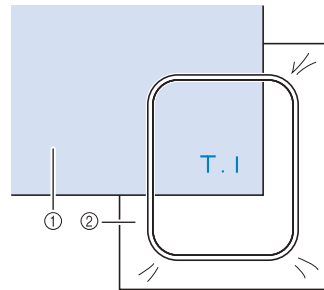

- ① Fabric
- ② Stabilizer

Embroidering ribbons or tape

Secure with double-sided tape or a temporary spray adhesive.

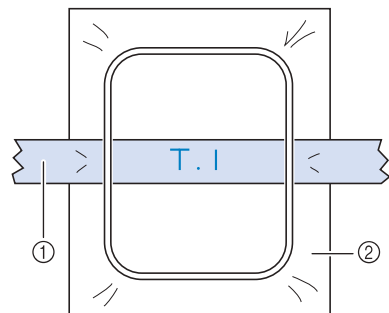

- ① Ribbon or tape
- ② Stabilizer

Attaching the Embroidery Frame



Note

- Wind and insert the bobbin before attaching the embroidery frame making sure to use the recommended bobbin thread.

1 Press (Presser foot lifter button) to raise the presser foot.

2 Raise the frame-securing lever.

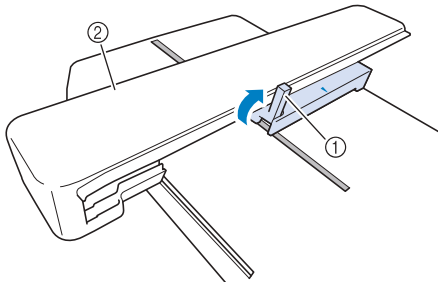

- ① Frame-securing lever
② Carriage

3 Align the embroidery frame guide with the right edge of the embroidery frame holder.

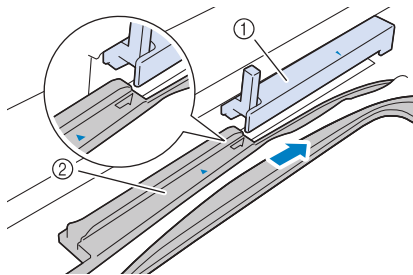

- ① Embroidery frame holder
② Embroidery frame guide

4 Slide the embroidery frame into the holder, making sure to align the embroidery frame's arrow mark with the one on holder.

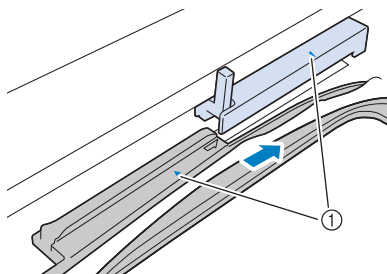

- ① Arrow mark

5 Lower the frame-securing lever to be level with the frame to secure the embroidery frame in the embroidery frame holder.

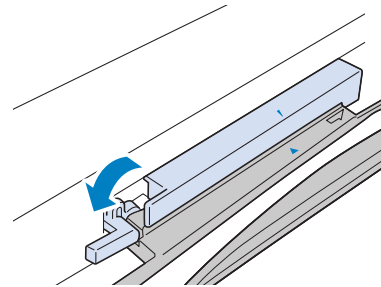

CAUTION

- If the frame-securing lever is not lowered, the following message appears. You cannot start sewing until you lower the frame-securing lever.

Make sure embroidery frame is moved as far back as possible. LOCK DOWN THE FRAME-SECURING LEVER.

OK

Removing the embroidery frame

1 Press (Presser foot lifter button) to raise the presser foot.

2 Raise the frame-securing lever.

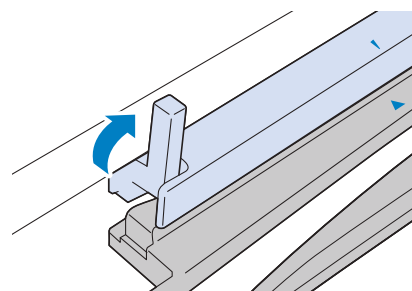

3 Pull the embroidery frame toward you.

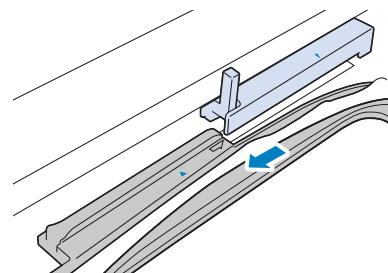

Selecting Embroidery Patterns

Copyright information

The patterns stored in the machine are intended for private use only. Any public or commercial use of copyrighted patterns is an infringement of copyright law and is strictly prohibited.

Embroidery pattern types

There are many character and decorative embroidery patterns stored in the machine's memory (see the "Embroidery Design Guide" for a full summary of patterns in the machine's memory). You can also use patterns from USB flash drive (sold separately).

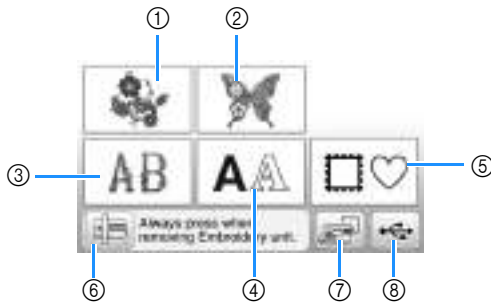

- ① Embroidery patterns
- ② Brother "Exclusives"
- ③ Floral alphabet patterns
- ④ Character patterns
- ⑤ Frame patterns
- ⑥ Press this key to position the embroidery unit for storage
- ⑦ Patterns saved in the machine's memory
- ⑧ Patterns saved in USB flash drive

Selecting an embroidery pattern

Select a simple pattern built-in your machine and embroider for testing purposes. You can try various selection of patterns and pattern editing in the "Embroidering" section.

1 Press in the pattern type selection screen.

- Once the machine has finished the initialization and the carriage has moved to the start position, the pattern type selection screen will display. If another screen is displayed, press to display the screen below.



2 Press or to display the desired pattern on the screen. Press 4 times in this procedure.

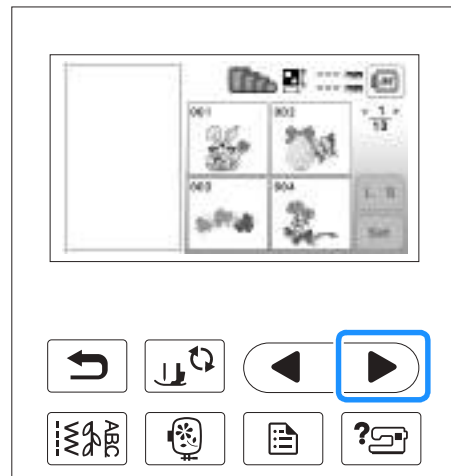

3 Press , and then .

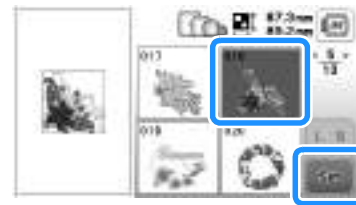

→ Pattern editing screen appears.

4 Press .

- For details on pattern editing screen, refer to "Editing Patterns" in the "Embroidering" section.



→ Embroidery settings screen appears.

5 Press .

- For details on embroidery settings screen, refer to "Editing Patterns" in the "Embroidering" section.
- Confirm the pattern position to be sewn, referring to "Confirming the Pattern Position" on page B-63.



→ Embroidering screen appears.

Confirming the Pattern Position

The pattern is normally positioned in the center of the embroidery frame. If the pattern needs to be repositioned for better placement on the garment, you can check the layout before starting embroidery.

Checking the pattern position

The embroidery frame moves and shows the pattern position. Watch the frame closely to make sure the pattern will be sewn in the right place.

- 1 Press  on the embroidery settings screen.



- 2 From , press the key for the position that you want to check.

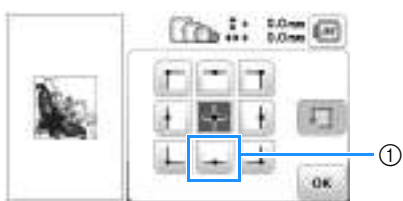

① Selected position

→ The needle will move to the selected position on the pattern.

Memo

- To see the entire embroidering area, press . The embroidery frame moves and shows the embroidery area.

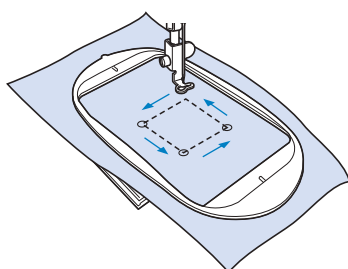

CAUTION

- Make sure the needle is up when the embroidery frame is moving. If the needle is down, it could break and result in injury.

- 3 Press .

Previewing the selected pattern

- 1 Press .







→ An image of the pattern as it will be embroidered appears.

- 2 Press     to select the frame used in the preview.

- Frames displayed in light gray cannot be selected.
- Press  to enlarge the image of the pattern.
- The pattern can be sewn as it appears in the following display.



■ Frame sizes displayed on screen

| Display | Frame type and embroidering area |
|---|--|
|  | Extra large embroidery frame 26 cm × 16 cm (10-1/4 inches × 6-1/4 inches) |
|  | Large embroidery frame (sold separately with some models) 18 cm × 13 cm (7 inches × 5 inches) |
|  | Medium embroidery frame (sold separately with some models) 10 cm × 10 cm (4 inches × 4 inches) |
|  | Small embroidery frame (sold separately with some models) 2 cm × 6 cm (1 inch × 2-1/2 inches) |

- 3 Press  to return to the original screen.

Embroidering

After the preparations are done, you can try embroidering. This section describes the steps for embroidering and appliquéing.

Embroidering a pattern

Embroidery patterns are embroidered with a change of thread after each color.

- 1 Prepare embroidery thread of the color shown on the screen.



① Embroidery color order

- The thread color number set displayed for the thread colors can be changed. Press , and then change the setting in the settings screen. For details, refer to “Changing the thread color display” on page B-65.

- 2 Set the embroidery thread, and thread the needle.

- Refer to “Threading the upper thread” on page B-24 and “Threading the needle” on page B-26.



Note

- Before using the needle threader, be sure to lower the presser foot.

- 3 Pass the thread through the embroidery foot hole, and hold it lightly in your left hand.

Give the thread a little slack.

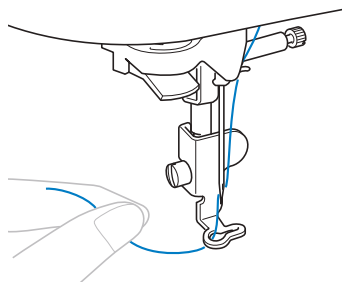

⚠ CAUTION

- If the thread is pulled too tight, the needle may break or bend.
- Do not let hands or objects hit the carriage while sewing. The pattern may misalign.

- 4 Lower the presser foot, then press the “Start/Stop” button to start embroidering. After 5-6 stitches, press the “Start/Stop” button again to stop the machine.

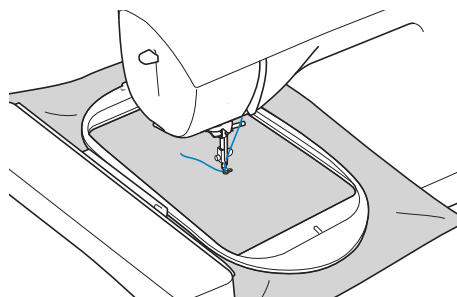

- 5 Trim the excess thread at the end of the seam. If the end of the seam is under the presser foot, raise the presser foot, then trim the excess thread.

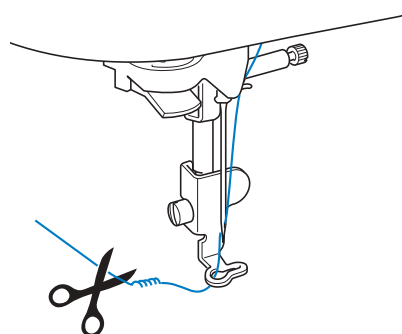

- If the thread is left at the beginning of the stitching, it may be sewn over as you continue embroidering the pattern, making it very difficult to deal with the thread after the pattern is finished. Trim the thread at the beginning.

- 6 Press the “Start/Stop” button to start embroidering.

→ Stitching stops automatically with reinforcement after one color has been completed. When automatic thread cutting is set, the thread is cut.

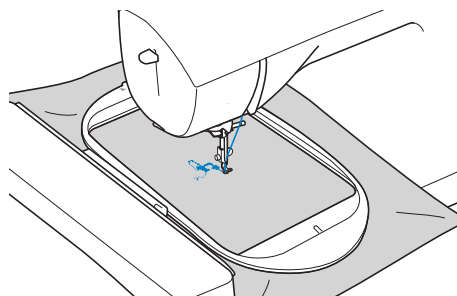

- 7 Remove the thread for the first color from the machine. Thread the machine with the next color.
- 8 Repeat the same steps for embroidering the remaining colors.



→ When the last color is sewn, the message informing that the embroidering is finished will appear on the display. Press **OK**, and the display will return to the initial screen.

Memo

- For the automatic thread cutting setting, refer to “Using the automatic thread cutting function (END COLOR TRIM)” in the “Embroidering” section.

- 9 Cut the excess thread jumps within the color.

Changing the thread color display

You can display the name of the thread colors or embroidery thread number.

Memo

- Colors on the screen may vary slightly from actual spool colors.

- 1 Press **INFO**.
- 2 Use **◀** or **▶** on operation panel to display the thread color selections.



- 3 Use **◀** or **▶** to select the name of the thread colors or the embroidery thread number.

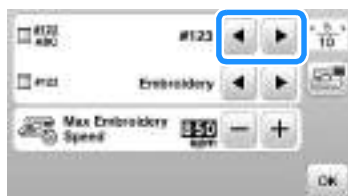

Thread color name



Thread number



- 4 When the thread number “#123” is displayed, use **◀** or **▶** to select from six embroidery thread brands pictured below.



Embroidery (polyester thread)

- 300 Embroidery
- 504 Embroidery
- 810 Embroidery
- 300 Embroidery

Country (cotton thread)*

- 306 Country
- 400 Country
- 110 Country
- 306 Country

Madeira Poly (polyester thread)

- 1000 Madeira Poly
- 1470 Madeira Poly
- 1211 Madeira Poly
- 1980 Madeira Poly

Madeira Rayon

- 1006 Madeira Rayon
- 1208 Madeira Rayon
- 1001 Madeira Rayon
- 1005 Madeira Rayon

Sulky

- 1118 Sulky
- 1508 Sulky
- 1121 Sulky
- 1218 Sulky

Robison-Anton (polyester thread)

- 8108 R.A. Poly
- 8101 R.A. Poly
- 8119 R.A. Poly
- 8116 R.A. Poly

* Depending on the country or area, cotton-like polyester thread is sold.

- 5 Press **OK**.



Sewing

This section describes procedures for using the various utility stitches as well as other functions. It provides details on basic sewing in addition to the more expressive features of the machine, such as sewing tubular pieces and buttonholes.
Page number starts with "S" in this section.

Chapter1 SEWING ATTRACTIVE FINISHES..... S-2

Chapter2 UTILITY STITCHES..... S-6

CAUTION

- Before replacing the presser foot, be sure to press  (Presser foot/Needle exchange key) on the operation panel to lock all keys and buttons, otherwise injuries may occur if the "Start/Stop" button or any other button is pressed and the machine starts. For details on changing the presser foot, refer to "Replacing the Presser Foot" in the "Basic operations" section.

Chapter 1 SEWING ATTRACTIVE FINISHES

Sewing Tips

Trial sewing

After you have set up the machine with the thread and needle appropriate for the type of fabric being sewn, the machine automatically sets the stitch length and width for the stitch that is selected. However, a trial piece of fabric should be sewn since, depending on the type of fabric and stitching being sewn, the desired results may not be achieved.

For the trial sewing, use a piece of fabric and thread that are the same as those used for your project, and check the thread tension and stitch length and width. Since the results differ depending on the type of stitching and the number of layers of fabric sewn, perform the trial sewing under the same conditions that will be used with your project.

Changing the sewing direction

- 1 **When the stitching reaches a corner, stop the machine.**
Leave the needle lowered (in the fabric). If the needle remains up when the machine stops sewing, press  (Needle position button) to lower the needle.
- 2 **Raise the presser foot lever, and then turn the fabric.**
Turn the fabric using the needle as a pivot.

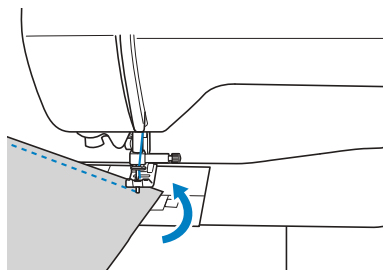

- 3 **Lower the presser foot lever and continue sewing.**

Sewing curves

Stop sewing, and then slightly change the sewing direction to sew around the curve. For details on sewing with an even seam allowance, refer to “Sewing an even seam allowance” on page S-3.

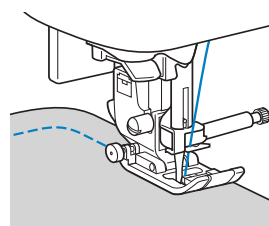

When sewing along a curve while using a zigzag stitch, select a shorter stitch length in order to obtain a finer stitch.

Sewing cylindrical pieces

Removing the flat bed attachment allows for free-arm sewing, making it easier to sew cylindrical pieces such as sleeve cuffs and pant legs.

- 1 **Pull the flat bed attachment off to the left.**

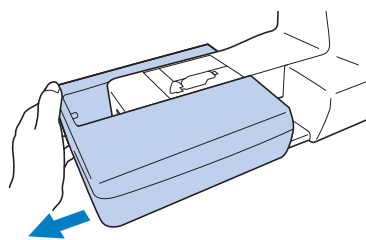

- 2 **Slide the part that you wish to sew onto the free arm, and then sew from the top.**

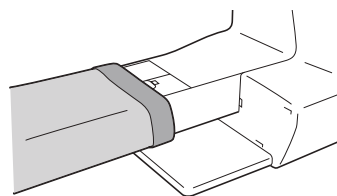

- 3 **When you are finished with free arm sewing, install the flat bed attachment back in its original position.**

Sewing an even seam allowance

To sew an even seam, start sewing so that the seam allowance is to the right of the presser foot, and the edge of the fabric is aligned with either the right edge of the presser foot or a marking on the needle plate.

■ Aligning the fabric with the presser foot

Sew while keeping the right edge of the presser foot a fixed distance from the edge of the fabric.

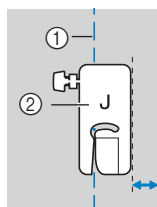

- ① Seam
- ② Presser foot

■ Aligning the fabric with the stitch guide foot (sold separately with some models)

Sew while keeping the right edge of the fabric aligned with a desired position of markings on the stitch guide foot.

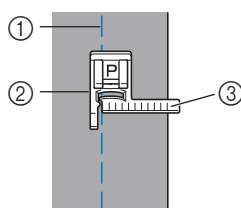

- ① Seam
- ② Stitch guide foot
- ③ Markings

■ Aligning the fabric with a needle plate marking

The markings on the needle plate show the distance from the needle position of a seam sewn with the straight stitch (left needle position). Sew while keeping the edge of the fabric aligned with a marking on the needle plate. The distance between the markings in the upper scale is 1/8 inch (3 mm) and the distance between the markings in the grid is 5 mm (3/16 inch).

For stitches with a left needle position
(Stitch width: 0.0 mm)

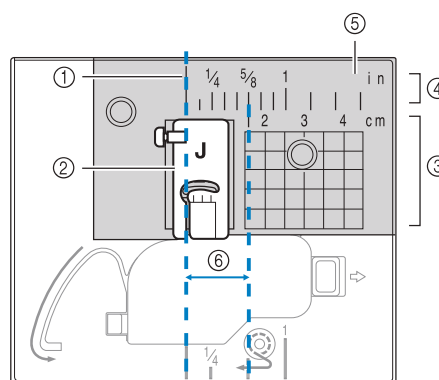

- ① Seam
- ② Presser foot
- ③ Centimeters
- ④ Inches
- ⑤ Needle plate
- ⑥ 1.6 cm (5/8 inch)

Sewing Various Fabrics

Sewing thick fabrics

■ If the fabric does not fit under the presser foot

If the fabric does not fit easily under the presser foot, raise the presser foot lever even higher to bring the presser foot to its highest position.

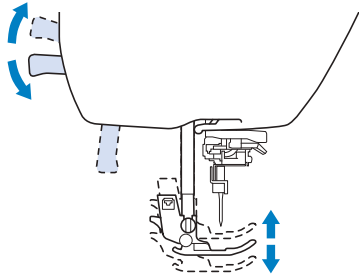

■ If thick seams are being sewn and the fabric does not feed at the beginning of stitching

The fabric may not feed when thick seams are being sewn and the presser foot is not level, as shown below. In this case, use the presser foot locking pin (black button on the left side of zigzag foot “J”) so that the presser foot remains level while sewing, allowing the fabric to be fed smoothly.

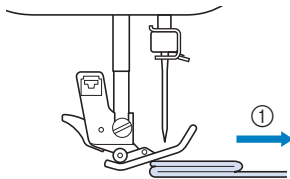

① Sewing direction

- 1 Raise the presser foot lever.
- 2 Align the beginning of stitching, and then position the fabric.
- 3 While holding zigzag foot “J” level, hold the presser foot locking pin (black button on the left side) pressed in, and lower the presser foot lever.

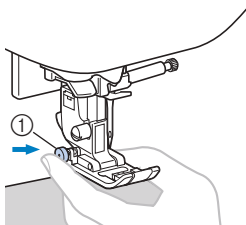

① Presser foot holding pin (black button)

4 Release the presser foot locking pin (black button).

→ The presser foot remains level, allowing the fabric to be fed.

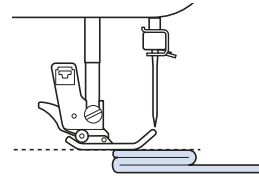

→ After the seam is sewn, the presser foot will return to its original angle.

Memo

- You may find adjusting the “Presser Foot Pressure” in the settings screen helpful on some thick fabrics.
- (For models equipped with Automatic Fabric Sensor System)
When “Automatic Fabric Sensor System” in the settings screen is set to “ON”, the thickness of the fabric is automatically detected by the internal sensor so the fabric can be fed smoothly for best sewing results. For details on the automatic fabric sensor system, refer to “Automatic Fabric Sensor System (Automatic presser foot pressure)” in the “Basic operations” section.

⚠ CAUTION

- If fabric more than 6 mm (15/64 inch) thick is sewn or if the fabric is pushed with too much force, the needle may bend or break.

Sewing thin fabrics

When sewing thin fabrics, the stitching may become misaligned or the fabric may not feed correctly. Move the needle (be sure to use a fine needle) to the furthest left or right hand position so that the fabric does not get pulled down into the feed dog area. If this occurs, place thin paper or stabilizer material under the fabric and sew it together with the fabric. When you have finished sewing, tear off any excess paper.

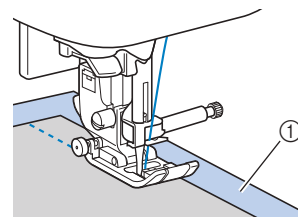

① Stabilizer material or paper





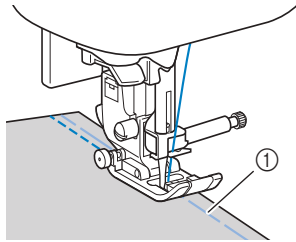

Sewing stretch fabrics

First, baste the pieces of fabric together, and then sew without stretching the fabric.



① Basting

For best results when sewing on knit fabrics use the stretch stitches. Also be sure to use a needle for knits. The recommended stitches and their stitch numbers are indicated below.

| Stitch |  |  |  |  |  |
|---|---|---|---|---|---|
| Model 4 | 1-05 | 1-06 | 1-13 | 1-14 | 2-13 |
| Model 3,2  | 05* | 06* | 13 | 14* | 48 |
| Model 1  | 05* | 06* | 11 | 12* | 42 |

* Stitch patterns can be selected directly by pressing the numeric keys on the machine during preset utility stitch mode. Refer to "Basic operations" section.

Sewing leathers or vinyl fabrics

When sewing fabrics that may stick to the presser foot such as leathers or coated fabrics, change the presser foot to the non stick foot*. The walking foot* is also suitable for sewing some leathers or vinyl fabrics.

* Sold separately with some models.

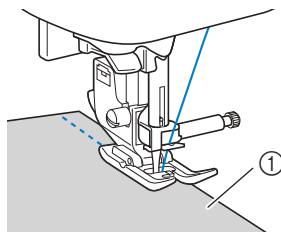

① Leather



Note

- The walking foot can only be used with straight or zigzag stitch patterns with reinforcement stitches. For details, refer to "Stitch Setting Chart" in the "Basic operations" section.
- When using the walking foot, test sew on a scrap piece of leather or vinyl that is to be used in project to make sure foot does not leave any marks.

Sewing hook-and-loop fastener tape

⚠ CAUTION

- Use only the adhesive-free hook-and-loop fastener tape which is designed for sewing. When the glue adheres to the needle or the bobbin hook race, it may cause malfunction.
- If the hook-and-loop fastener tape is sewn with the thin needle (65/9-75/11), the needle may bend or break.



Note

- Before sewing, baste together the fabric and the hook-and-loop fastener tape.

Make sure that the needle passes through the hook-and-loop fastener tape by turning the handwheel and lower the needle into the hook-and-loop fastener tape before sewing. And then, sew the edge of the hook-and-loop fastener tape at a slow speed.

If the needle does not pass through the hook-and-loop fastener tape, replace the needle with the needle size for thicker fabrics. For details, refer to "Fabric/thread/needle combinations" in the "Basic operations" section.

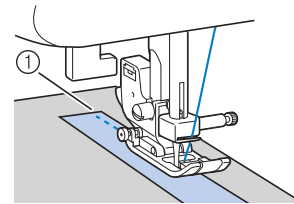

① Edge of the hook-and-loop fastener tape

Chapter 2 UTILITY STITCHES

Basic Stitching

Straight stitches are used for sewing plain seams.

- Using the table below, refer to "Using the utility stitch tables in the "Sewing" section" in the "Basic operations" section.

| Stitch name | Stitch | Model 4 | Model 3, 2 | | Presser foot |
|--------------------------|--------|---------|------------|---------|--------------|
| | | | Model 3, 2 | Model 1 | |
| Stitch number | | | | | |
| Basting stitch | | 1-08 | 08 | 07 | J |
| Straight stitch (Left) | | 1-01 | 01* | 01* | |
| | | 1-02 | 02* | 02* | |
| Straight stitch (Middle) | | 1-03 | 03* | 03* | |
| Straight stitch (Middle) | | 1-04 | 04* | 04* | |
| Triple stretch stitch | | 1-05 | 05* | 05* | |

* Stitch patterns can be selected directly by pressing the numeric keys on the machine during preset utility stitch mode. Refer to "Basic operations" section.

Basting

Sew basting with a stitch length between 5 mm (3/16 inch) and 30 mm (1-3/16 inches).

- Attach zigzag foot "J".

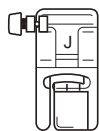

- Select stitch
- Start sewing.

Basic stitching

- Baste or pin together the fabric pieces.

- Attach zigzag foot "J".

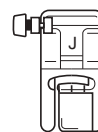

- Select a stitch.

- Lower the needle into the fabric at the beginning of the stitching.

- Lower the presser foot lever, and then start sewing.

- When sewing is finished, cut the thread.



■ Changing the needle position

The needle position used as the baseline is different for the straight stitch (left needle position) and the straight stitch (center needle position).

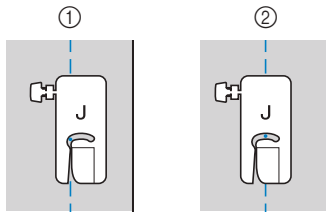

- ① Straight stitch (left needle position)
- ② Straight stitch (center needle position)

When the stitch width of the straight stitch (left needle position) is set to its standard setting (0.0 mm), the distance from the needle position to the right side of the presser foot is 12 mm (1/2 inch). If the stitch width is changed (between 0 and 7.0 mm (1/4 inch)), the needle position will also change. By changing the stitch width and sewing with the right side of the presser foot aligned with the edge of the fabric, a seam allowance can be sewn with a fixed width.

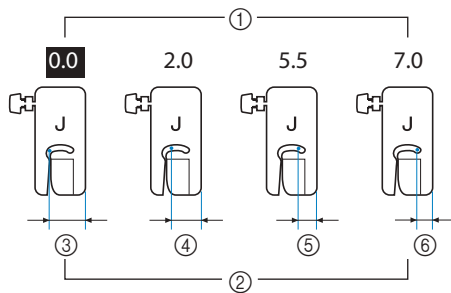

- ① Stitch width setting
- ② Distance from the needle position to the right side of the presser foot
- ③ 12.0 mm (1/2 inch)
- ④ 10.0 mm (3/8 inch)
- ⑤ 6.5 mm (1/4 inch)
- ⑥ 5.0 mm (3/16 inch)

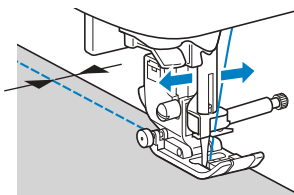

- For details, refer to “Setting the stitch width” in the “Basic operations” section.

Blind Hem Stitching

Secure the bottoms of skirts and pants with a blind hem.

- Using the table below, refer to "Using the utility stitch tables in the "Sewing" section" in the "Basic operations" section.

| Stitch name | Stitch | Model 4 | Model 3, 2 | | Presser foot |
|--------------------------|--------|---------|------------|---------|--------------|
| | | | Model 3 | Model 2 | |
| Stitch number | | | | | |
| Blind hem stitch | | 2-01 | 36 | 31 | R |
| Blind hem stretch stitch | | 2-02 | 37 | 32 | |



Memo

- When the size of cylindrical pieces is too small to slide onto the arm or the length is too short, the fabric will not feed and desired results may not be achieved.

1 Turn the skirt or pants wrong side out.

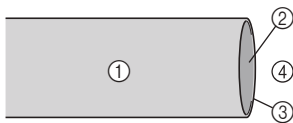

- ① Wrong side of fabric
- ② Right side of fabric
- ③ Edge of fabric
- ④ Bottom side

2 Fold the fabric along the desired edge of the hem, and press.

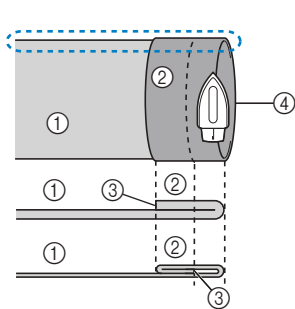

- ① Wrong side of fabric
- ② Right side of fabric
- ③ Edge of fabric
- ④ Desired edge of hem

<Thick fabric>

<Normal fabric>

<Seen from the side>

3 Use a chalk to mark on the fabric about 5 mm (3/16 inch) from the edge of the fabric, and then baste it.

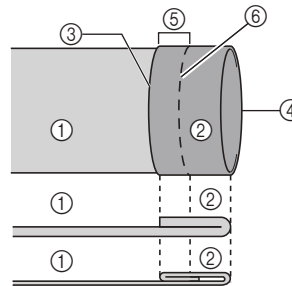

- ① Wrong side of fabric
- ② Right side of fabric
- ③ Edge of fabric
- ④ Desired edge of hem
- ⑤ 5 mm (3/16 inch)
- ⑥ Basting

<Thick fabric>

<Normal fabric>

<Seen from the side>

4 Fold back the fabric inside along the basting.

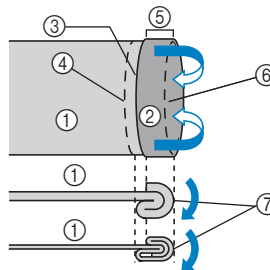

- ① Wrong side of fabric
- ② Right side of fabric
- ③ Edge of fabric
- ④ Desired edge of hem
- ⑤ 5 mm (3/16 inch)
- ⑥ Basting
- ⑦ Basting point

<Thick fabric>

<Normal fabric>

<Seen from the side>

5 Unfold the edge of fabric, and position the fabric with the wrong side facing up.

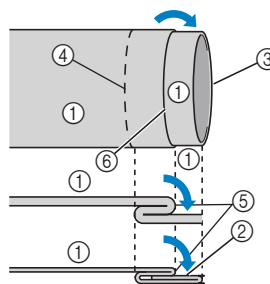

- ① Wrong side of fabric
- ② Right side of fabric
- ③ Edge of fabric
- ④ Desired edge of hem
- ⑤ Basting point
- ⑥ Basting

<Thick fabric>

<Normal fabric>

<Seen from the side>

6 Attach blind hem foot "R".

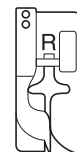

7 Select or .

8 Remove the flat bed attachment to use the free arm.

- 9 Slide the item that you wish to sew onto the free arm, make sure that the fabric feeds correctly, and then start sewing.

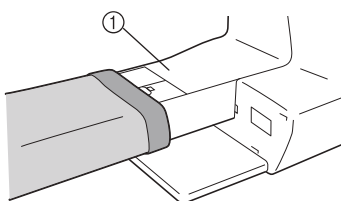

① Free arm

- 10 Position the fabric with the edge of the folded hem against the guide of the presser foot, and then lower the presser foot lever.

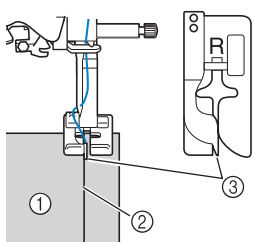

① Wrong side of fabric
② Fold of hem
③ Guide

- 11 Adjust the stitch width until the needle slightly catches the fold of the hem.

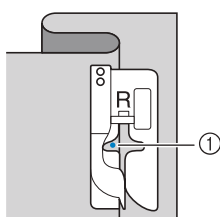

① Needle drop point

When you change the needle drop point, raise the needle, and then change the stitch width.

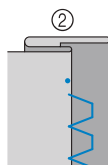
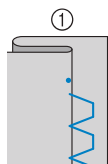
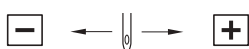

① Thick fabric
② Normal fabric

Memo

- Blind hem stitches cannot be sewn if the left needle drop point does not catch the fold. If the needle catches too much of the fold, the fabric cannot be unfolded and the seam appearing on the right side of the fabric will be very large, leaving an unattractive finish. If you experience either of these cases, perform the following instructions to solve the problem.

■ If the needle catches too much of the hem fold

The needle is too far to the left.

Decrease the stitch width so that the needle slightly catches the fold of the hem.

□ Example: Thick fabric

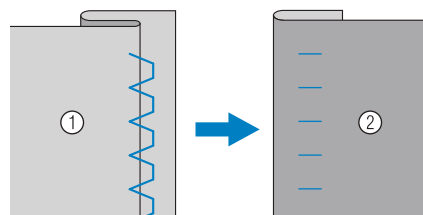

□ Example: Normal fabric

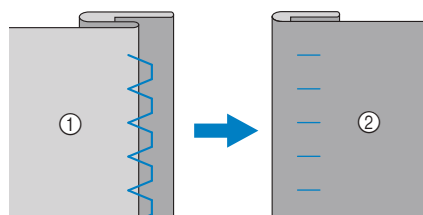

① Wrong side of fabric
② Right side of fabric

■ **If the needle does not catch the hem fold**

The needle is too far to the right.
Increase the stitch width so that the needle slightly catches the fold of the hem.

□ **Example:** Thick fabric

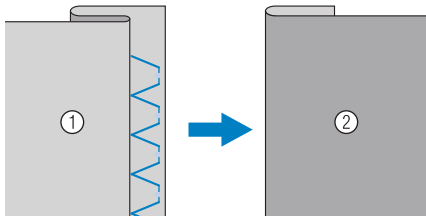

□ **Example:** Normal fabric

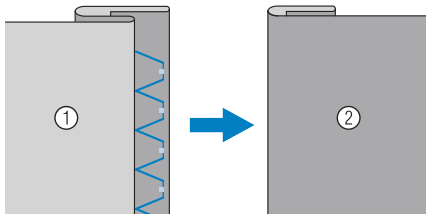

- ① Wrong side of fabric
- ② Right side of fabric

12 Sew with the fold of the hem against the presser foot guide.

13 Press the “Start/Stop” button to stop sewing when you are finished, and raise the presser foot and needle to remove the fabric by pulling it back.



Note

- Be sure to pull the fabric backward after finished sewing. If you pull the fabric toward side or forward, the presser foot may be damaged.

14 Remove the basting stitching and reverse the fabric.

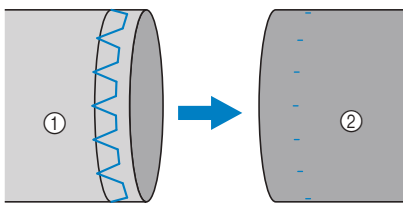



- ① Wrong side of fabric
- ② Right side of fabric

Overcasting Stitches

Sew overcasting stitches along the edges of cut fabric to prevent them from fraying.

Sewing overcasting stitches using overcasting foot "G"

- Using the table below, refer to "Using the utility stitch tables in the "Sewing" section" in the "Basic operations" section.

| Stitch name | Stitch | Model 4 | Model 3, 2 | | Presser foot |
|--------------------|---|---------|------------|---------|--------------|
| | | | Model 3, 2 | Model 1 | |
| Stitch number | | | | | |
| Overcasting stitch |  | 1-15 | 15* | 13* | G |
| |  | 1-16 | 16 | 14 | |
| |  | 1-17 | 17 | 15 | |

* Stitch patterns can be selected directly by pressing the numeric keys on the machine during preset utility stitch mode. Refer to "Basic operations" section.

1 Attach overcasting foot "G".



2 Select a stitch.

3 Position the fabric with the edge of the fabric against the guide of the presser foot, and then lower the presser foot lever.

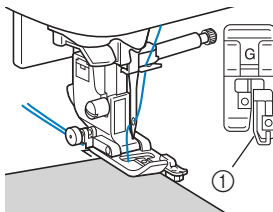

① Guide

4 Sew with the edge of the fabric against the presser foot guide.

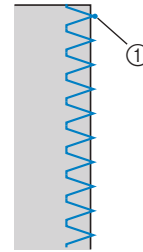

① Needle drop point

⚠ CAUTION

- After the stitch width is adjusted, rotate the handwheel toward you (counterclockwise). Check that the needle does not touch the presser foot. If the needle hits the presser foot, the needle may break and cause injury.

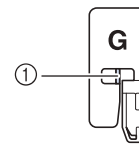

- ① The needle should not touch the center bar
- If the presser foot is raised to its highest level, the needle may strike the presser foot.

5 Press the "Start/Stop" button to stop sewing when you are finished, and raise the presser foot and needle to remove the fabric by pulling it back.

Sewing overcasting stitches using zigzag foot "J"

- Using the table below, refer to "Using the utility stitch tables in the "Sewing" section" in the "Basic operations" section.

| Stitch name | Stitch | Model 4 | Model 3, 2 | | Presser foot |
|--------------------------------|--------|---------|------------|---------|--------------|
| | | | Model 3, 2 | Model 1 | |
| Stitch number | | | | | |
| Zigzag stitch | | 1-09 | 09* | 08* | J |
| Zigzag stitch (Right) | | 1-11 | 11 | 10 | |
| 2 steps elastic zigzag stitch | | 1-13 | 13 | 11 | |
| 3 steps elastic zigzag stitch | | 1-14 | 14* | 12* | |
| Overcasting stitch | | 1-18 | 18 | 16 | |
| | | 1-19 | 19 | 17 | |
| | | 1-20 | 20 | 18 | |
| | | 1-21 | 21 | 19 | |
| Single diamond overcast stitch | | 1-22 | 22 | - | |
| | | 1-23 | 23 | - | |

* Stitch patterns can be selected directly by pressing the numeric keys on the machine during preset utility stitch mode. Refer to "Basic operations" section.

- Attach zigzag foot "J".

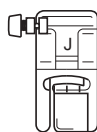

- Select a stitch.

- Sew along the edge of the fabric with the needle dropping off the edge at the right.

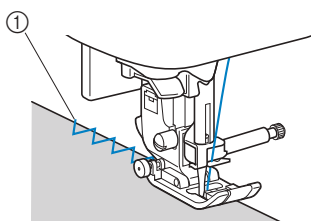

① Needle drop point

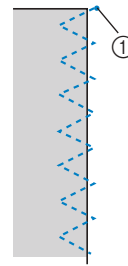

① Needle drop point

Sewing overcasting stitches using the side cutter (sold separately with some models)

Using the side cutter, seam allowances can be finished while the edge of the fabric is cut off. Five utility stitches can be used to sew overcasting stitches with the side cutter.

- Using the table below, refer to "Using the utility stitch tables in the "Sewing" section" in the "Basic operations" section.



Note

- Thread the needle manually when using the side cutter, or only attach the side cutter after threading the needle using the needle threader.

| Stitch name | Stitch | Model 4 | Model 3, 2 | | Presser foot |
|------------------|--------|---------|------------|---------|--------------|
| | | | Model 3, 2 | Model 1 | |
| Stitch number | | | | | |
| With side cutter | | 1-24 | 24 | 20 | S |
| | | 1-25 | 25 | 21 | |
| | | 1-26 | 26 | 22 | |
| | | 1-27 | 27 | 23 | |
| | | 1-28 | 28 | 24 | |

□ Side cutter

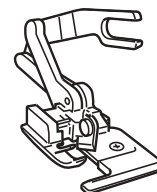

- 1 Remove the presser foot.
- 2 Hook the connecting fork of the side cutter onto the needle clamp screw.

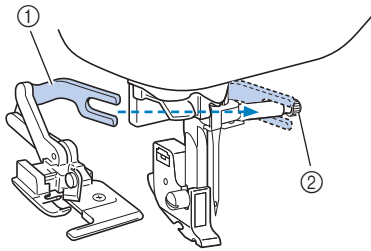

- ① Connecting fork
- ② Needle clamp screw

- 3 Position the side cutter so that side cutter pin is aligned with the notch in the presser foot holder, and then slowly lower the presser foot lever.

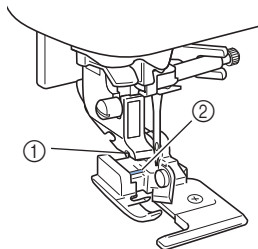

- ① Notch in presser foot holder
- ② Pin

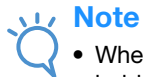
**Note**

- When it is hard to set under the presser foot holder, fit the pin on the side cutter into the notch of the presser foot holder raising up the presser foot lever higher.

- 4 Raise the presser foot lever to check that the side cutter is securely attached.
- 5 Pass the upper thread under the side cutter, and then pull it out toward the rear of the machine.

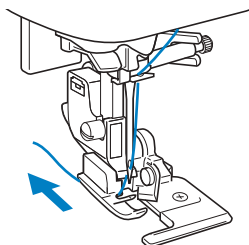

- 6 Select a stitch.
- 7 Make a cut of about 2 cm (3/4 inch) long in the fabric at the beginning of the stitching.

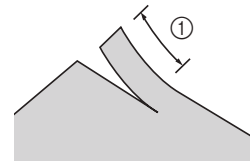

- ① 2 cm (3/4 inch)

- 8 Position the fabric in the side cutter. The cut in the fabric should be positioned over the guide plate of the side cutter.

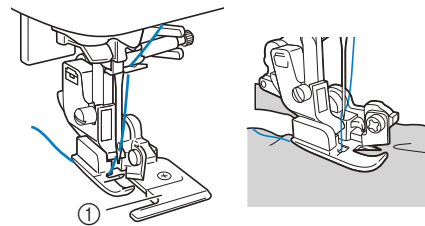

- ① Guide plate
- If the fabric is not positioned correctly, the fabric will not be cut.

- 9 Lower the presser foot lever, and then start sewing.

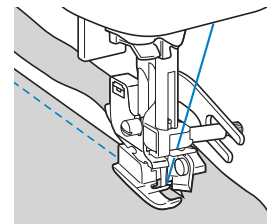

→ A seam allowance is cut while the stitching is sewn.

- If the stitching is sewn in a straight line , the seam allowance will be about 5 mm (3/16 inch).

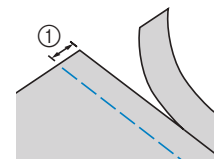













- ① 5 mm (3/16 inch)

**Memo**

- The side cutter can cut as much as one layer of 13-oz. denim.
- After using the side cutter, clean it by removing any lint or dust.
- If the side cutter can no longer cut fabric, use a piece of cloth to apply a small amount of oil to the cutting edge of the cutter.

Buttonhole Stitching/Button Sewing

- Using the table below, refer to "Using the utility stitch tables in the "Sewing" section" in the "Basic operations" section.

| Stitch name | Stitch | Model 4 |  | | Presser foot |
|---------------------------------------|---|---------------|---|---------|--------------|
| | | | Model 3, 2 | Model 1 | |
| | | Stitch number | | | |
| Narrow rounded buttonhole stitch |  | 4-01 | 77 | 57 | A |
| Tapered round ended buttonhole stitch |  | 4-02 | 78 | 58 | |
| Round ended buttonhole stitch |  | 4-03 | 79 | 59 | |
| Narrow squared buttonhole stitch |  | 4-04 | 80 | 60 | |
| Stretch buttonhole stitch |  | 4-05 | 81 | 61 | |
| Heirloom buttonhole stitch |  | 4-06 | 82 | 62 | |
| Bound buttonhole stitch |  | 4-07 | 83 | 63 | |
| Keyhole buttonhole stitch |  | 4-08 | 84 | 64 | |
| Tapered keyhole buttonhole stitch |  | 4-09 | 85 | 65 | |
| Keyhole buttonhole stitch |  | 4-10 | 86 | 66 | |
| Button sewing stitch |  | 4-14 | 90 | 70 | M |

Buttonhole sewing

The maximum buttonhole length is about 28 mm (1-1/8 inches) (diameter + thickness of the button).

Buttonholes are sewn from the front of the presser foot to the back, as shown below.

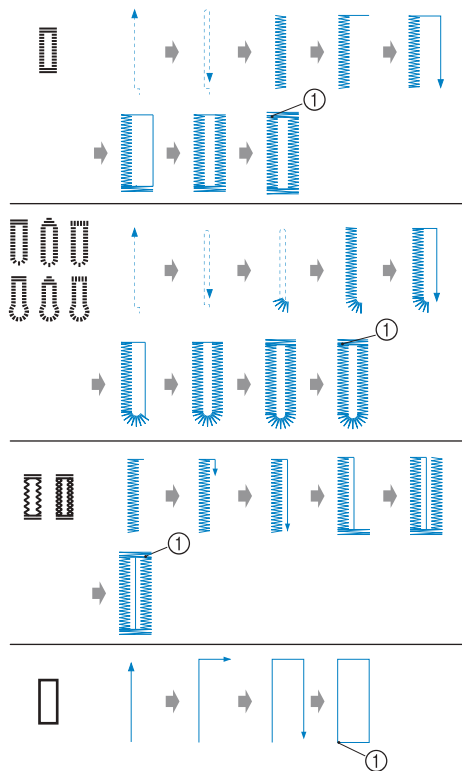

① Reinforcement stitching

The names of parts of buttonhole foot "A", which is used to create buttonholes, are indicated below.

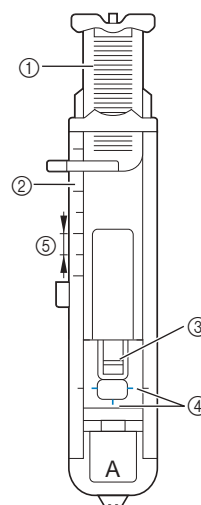

- ① Button guide plate
- ② Presser foot scale
- ③ Pin
- ④ Marks on buttonhole foot
- ⑤ 5 mm (3/16 inch)

- 1** Use chalk to mark on the fabric the position and length of the buttonhole.

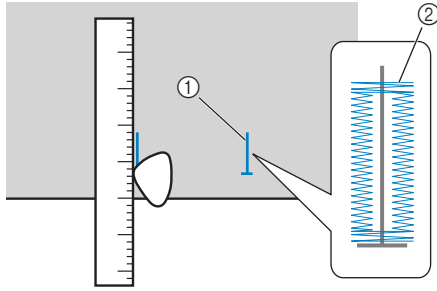

- ① Marks on fabric
- ② Buttonhole sewing

- 2** Pull out the button guide plate of buttonhole foot "A", and then insert the button that will be put through the buttonhole.

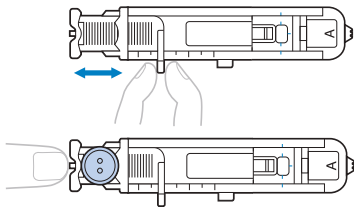

■ If the button does not fit in the button guide plate

Add together the diameter and thickness of the button, and then set the button guide plate to the calculated length. (The distance between the markings on the presser foot scale is 5 mm (3/16 inch).)

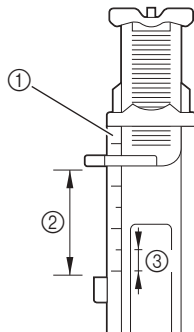

- ① Presser foot scale
- ② Length of buttonhole (diameter + thickness of button)
- ③ 5 mm (3/16 inch)

Example: For a button with a diameter of 15 mm (9/16 inch) and a thickness of 10 mm (3/8 inch), the button guide plate should be set to 25 mm (1 inch) on the scale.

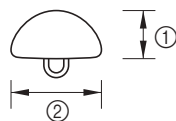

- ① 10 mm (3/8 inch)
- ② 15 mm (9/16 inch)

→ The size of the buttonhole is set.

- 3** Attach buttonhole foot "A".

- 4** Select a stitch.

- 5** Position the fabric with the front end of the buttonhole mark aligned with the red marks on the sides of the buttonhole foot, and then lower the presser foot lever.

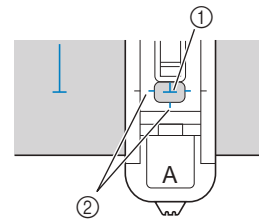

- ① Mark on fabric (front)
- ② Red marks on buttonhole foot

Pass the upper thread down through the hole in the presser foot.

- When lowering the presser foot, do not push in the front of the presser foot.

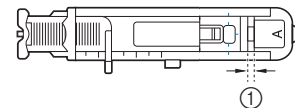
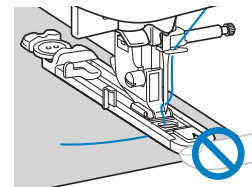

- ① Do not reduce the gap.

- 6** Pull down the buttonhole lever as far as possible.

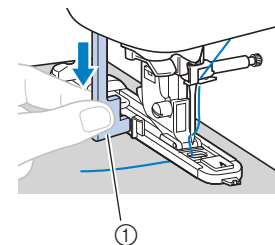

- ① Buttonhole lever
- The buttonhole lever is positioned behind the bracket on the buttonhole foot.

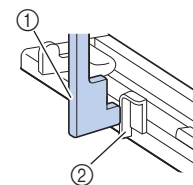

- ① Buttonhole lever
- ② Bracket

- 7** Gently hold the end of the upper thread in your left hand, and then start sewing.

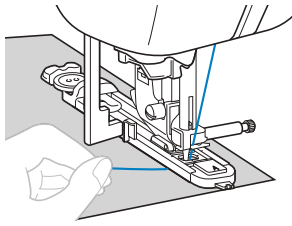

→ Once sewing is completed, the machine automatically sews reinforcement stitches, then stops.

- 8** Press  (Thread cutter button) once. Raise the presser foot, and then remove the fabric.

 **Memo**

- If the automatic thread cutting setting was selected before sewing, the machine will automatically cut the threads at the end of the stitching. For details, refer to “Automatically cutting the thread” in the “Basic operations” section.
- When using the thread cutter on the left side of the machine or scissors to cut the threads, press  (Needle position button) to raise the needle, raise the presser foot, and then pull out the fabric before cutting the threads.

- 9** Raise the buttonhole lever to its original position.

- 10** Insert a pin along the inside of one bar tack at the end of the buttonhole stitching to prevent the stitching from being cut.

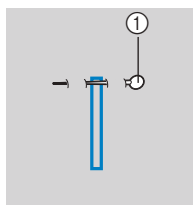

① Pin

- 11** Use the seam ripper to cut towards the pin and open the buttonhole.

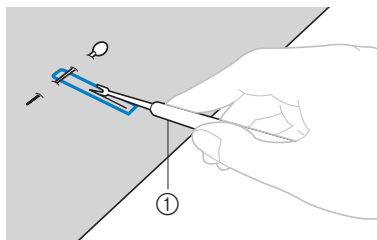

① Seam ripper

For keyhole buttonholes, use the eyelet punch to make a hole in the rounded end of the buttonhole, and then use the seam ripper to cut open the buttonhole.

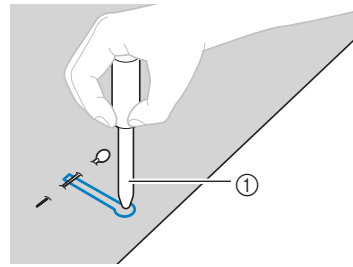

① Eyelet punch

- When using the eyelet punch, place thick paper or some other protective sheet under the fabric before punching the hole in the fabric.

CAUTION

- When opening the buttonhole with the seam ripper, do not place your hands in the cutting direction, otherwise injuries may result if the seam ripper slips.
- Do not use the seam ripper in any other way than how it is intended.

■ **Changing the density of the stitching**

Adjust the stitch length.

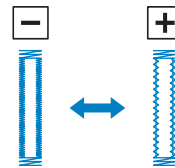

- For details, refer to “Setting the stitch length” in the “Basic operations” section.
- If the fabric does not feed (for example, if it is too thick), decrease the density of the stitching.

■ **Changing the stitch width**

Adjust the stitch width.

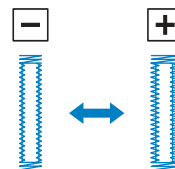

- For details, refer to “Setting the stitch width” in the “Basic operations” section.

 **Memo**

- Before sewing buttonholes, check the stitch length and width by sewing a trial buttonhole on a scrap piece of fabric.

■ **Sewing buttonholes on stretch fabrics**

When sewing buttonholes on stretch fabrics, use a gimp thread.

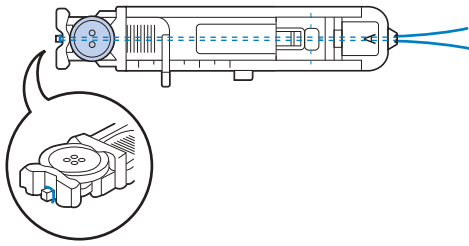

- Hook the gimp thread onto the part of buttonhole foot "A" shown in the illustration.

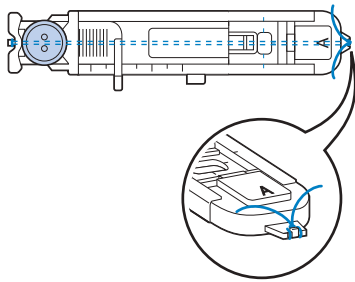

- It fits into the grooves, and then loosely tie it.



- Attach buttonhole foot "A".

- Select stitch  or .

- Adjust the stitch width to the thickness of the gimp thread.

- Lower the presser foot lever and the buttonhole lever, and then start sewing.

- When sewing is finished, gently pull the gimp thread to remove any slack.

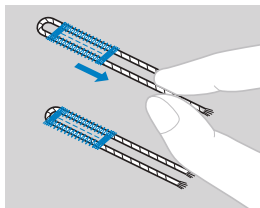



- Use a handsewing needle to pull the gimp thread to the wrong side of the fabric, and then tie it.

Button sewing

Buttons can be sewn on with the machine. Buttons with two or with four holes can be attached.

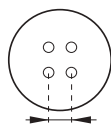
- Measure the distance between the holes in the button to be attached.



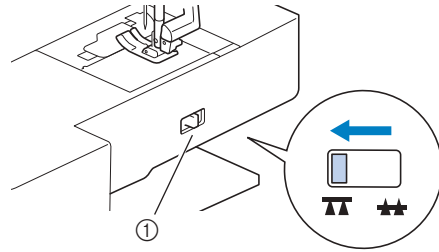

- Raise the presser foot lever, and then slide the feed dog position switch, located at the rear of the machine on the base, to  (to the left as seen from the rear of the machine).

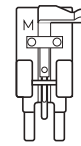

- ① Feed dog position switch (as seen from the rear of the machine)

- Attach button fitting foot "M".



- Select stitch .

- Since the end of the thread will be tied off later, do not set the machine for programmed-thread cutting.

- Adjust the stitch width so that it is the same as the distance between the holes in the button.

- Place the button in the position where it will be sewn, and lower the presser foot lever.

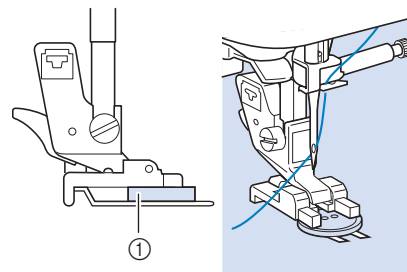

- ① Button

- When attaching four-hole buttons, first sew the two holes closest to you. Then, slide the button so that the needle goes into the two holes toward the rear of the machine, and then sew them in the same way.

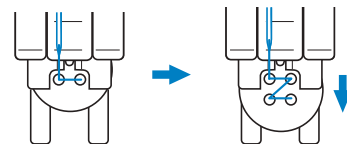

- 7 Turn the handwheel toward you (counterclockwise) to check that the needle correctly goes into the two holes of the button.**

If it seems as if the needle will hit the button, remeasure the distance between the holes in the button. Adjust the stitch width to the distance between the buttonholes.

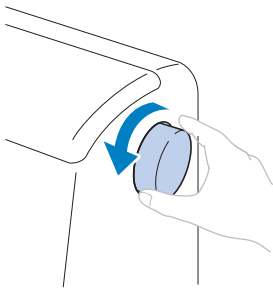

⚠ CAUTION

- When sewing, be sure that the needle does not touch the button, otherwise the needle may bend or break.

- 8 Start sewing.**

Set the sewing speed controller to the left (so that the speed will be slow).

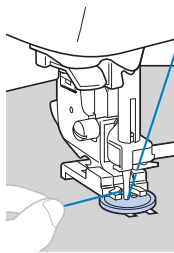



→ The machine automatically stops after sewing reinforcement stitches.

- Do not press  (Thread cutter button).

- 9 Use scissors to cut the upper thread and the bobbin thread at the beginning of the stitching.**

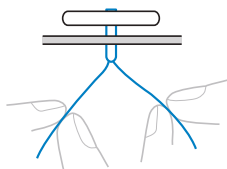
Pull the upper thread at the end of the stitching to the wrong side of the fabric, and then tie it with the bobbin thread.



- 10 When you are finished attaching the button, slide the feed dog position switch, to  (to the right as seen from the rear of the machine) and turn the handwheel to raise the feed dogs.**



Memo

- The feed dogs come up when you start sewing again.

■ Attaching a shank to a button

To sew the button with a shank, attach the button with space between it and the fabric, and then wind the thread by hand. This attaches the button securely.

- 1 Place the button into button fitting foot “M”, and then pull the shank lever toward you.**

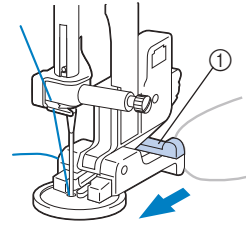

① Shank lever

- 2 After sewing is finished, cut the upper thread with plenty of excess, wind it around the thread between the button and the fabric, and then tie it to the upper thread at the beginning of the stitching.**

Tie together the ends of the bobbin thread at the end and at the beginning of the stitching at the wrong side of the fabric.



- 3 Cut off any excess thread.**

Zipper Insertion

- Using the table below, refer to "Using the utility stitch tables in the "Sewing" section" in the "Basic operations" section.

| Stitch name | Stitch | Model 4 | Model 3, 2 | | Presser foot |
|---------------------------------|---|---------------|------------|-----|--------------|
| | | Stitch number | | | |
| Straight stitch (Middle) |  | 1-03 | 03* | 03* | J, I |

* Stitch patterns can be selected directly by pressing the numeric keys on the machine during preset utility stitch mode. Refer to "Basic operations" section.

Inserting a centered zipper

Stitching is sewn on both pieces of fabric butted against each other.

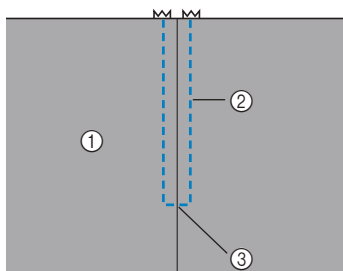

- ① Right side of fabric
- ② Stitching
- ③ End of zipper opening

- 1** Attach zigzag foot "J".
- 2** Sew straight stitches up to the zipper opening. With the right sides of the fabric facing each other, sew reverse stitches after reaching the zipper opening.
- 3** Using a basting stitch, continue sewing to the edge of the fabric.

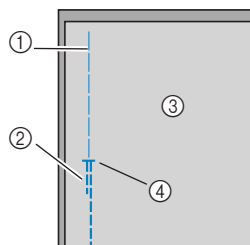

- ① Basting stitching
- ② Reverse stitches
- ③ Wrong side of fabric
- ④ End of zipper opening

- 4** Press open the seam allowance from the wrong side of the fabric.

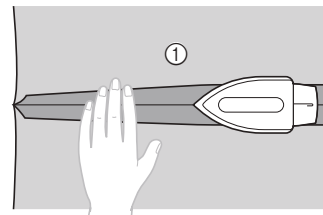

- 5** Align the seam with the center of the zipper, and then baste the zipper in place.

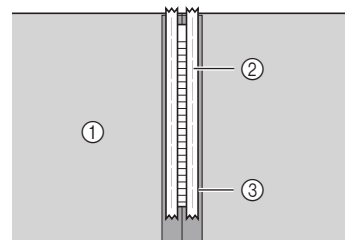

- 6** Remove about 5 cm (2 inches) from the end of the basting on the outside.

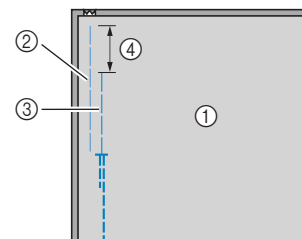

- 7** Attach the presser foot holder to the right pin of zipper foot "I".

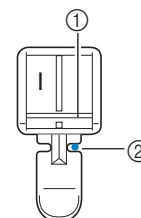

- ① Pin on the right side
- ② Needle drop point

UTILITY STITCHES

8 Select stitch 

CAUTION

- When using zipper foot "1", be sure to select the straight stitch (center needle position), and slowly turn the handwheel toward you (counterclockwise) to check that the needle does not touch the presser foot. If a different stitch is selected or the needle hits the presser foot, the needle may bend or break.

9 Topstitch around the zipper.

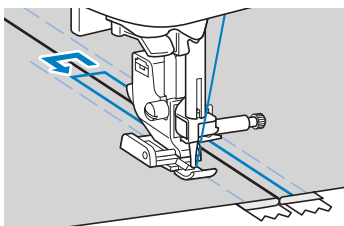
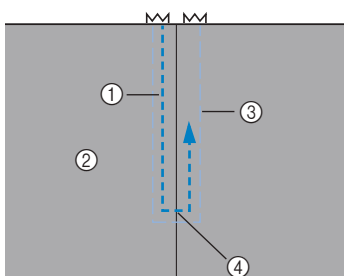

- 1 Stitching
- 2 Right side of fabric
- 3 Basting stitching
- 4 End of zipper opening

CAUTION

- When sewing, be sure that the needle does not touch the zipper, otherwise the needle may bend or break.

10 Remove the basting stitching.

Inserting a side zipper

Stitching is visible on only one piece of fabric. Use this type of zipper application for side openings and back openings.

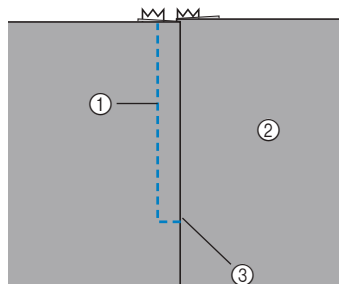

- 1 Stitching
- 2 Right side of fabric
- 3 End of zipper opening

The following procedure will describe how to stitch on the left side, as shown in the illustration.

1 Attach zigzag foot "J".

2 Sew straight stitches up to the zipper opening.

With the right sides of the fabric facing each other, sew reverse stitches after reaching the zipper opening.

3 Using a basting stitch, continue sewing to the edge of the fabric.

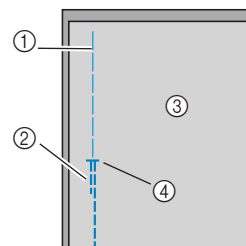

- 1 Basting stitching
- 2 Reverse stitches
- 3 Wrong side of fabric
- 4 End of zipper opening

4 Press open the seam allowance from the wrong side of the fabric.

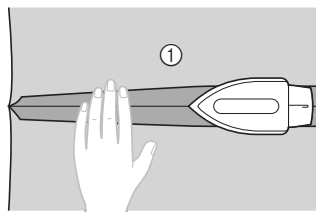

- 1 Wrong side of fabric

- 5 Press the seam allowance so that the right side (the side that will not be stitched) has an extra 3 mm (1/8 inch).

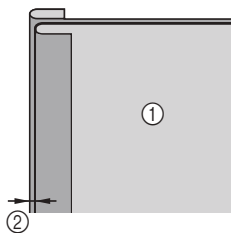

- ① Wrong side of fabric
② 3 mm (1/8 inch)

- 6 Align the zipper teeth with the pressed edge of the fabric having the extra 3 mm (1/8 inch), and then baste or pin the zipper in place.

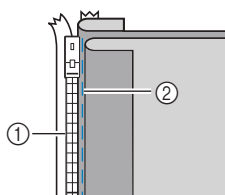

- ① Zipper teeth
② Basting stitching

- 7 Attach the presser foot holder to the right pin of zipper foot "I".

If the stitching will be sewn on the right side, attach the presser foot holder to the left pin of the zipper foot.

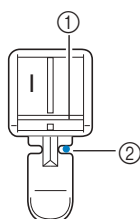

- ① Pin on the right side
② Needle drop point

- 8 Select stitch .

CAUTION

- When using zipper foot "I", be sure to select the straight stitch (center needle position), and slowly turn the handwheel toward you (counterclockwise) to check that the needle does not touch the presser foot. If a different stitch is selected or the needle hits the presser foot, the needle may bend or break.

- 9 Sew the zipper to the piece of fabric with the extra 3 mm (1/8 inch), starting from the base of the zipper.

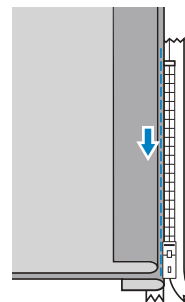

CAUTION

- When sewing, be sure that the needle does not touch the zipper, otherwise the needle may bend or break.

- 10 When you are about 5 cm (2 inches) from the end of the zipper, stop the machine with the needle lowered (in the fabric), raise the presser foot lever.

- 11 Open the zipper and continue sewing.

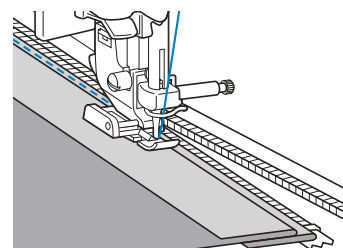

- 12 Close the zipper, turn over the fabric, and then baste the other side of the zipper to the fabric.

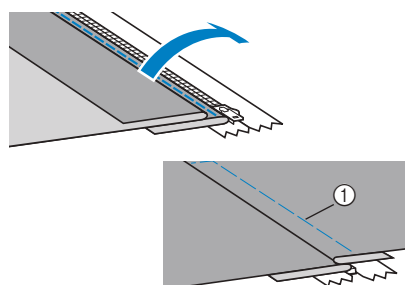

- ① Basting stitching

- 13 Attach the presser foot holder to the other pin of zipper foot "I".

If the presser foot holder was attached to the right pin in step 7, change it to the left pin.

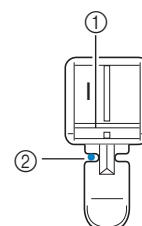

- ① Pin on the left side
② Needle drop point

14 Topstitch around the zipper.

Sew reverse stitches at the end of the zipper opening and align the zipper teeth with the side of the presser foot.

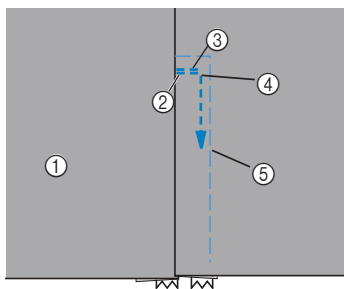

- ① Right side of fabric
- ② End of zipper opening
- ③ Reverse stitches
- ④ Beginning of stitching
- ⑤ Basting stitching

! CAUTION

- When sewing, be sure that the needle does not touch the zipper, otherwise the needle may bend or break.

15 When you are about 5 cm (2 inches) from the end of the zipper, stop the machine with the needle lowered (in the fabric), and then raise the presser foot lever.

16 Remove the basting stitching, open the zipper, and then continue sewing.

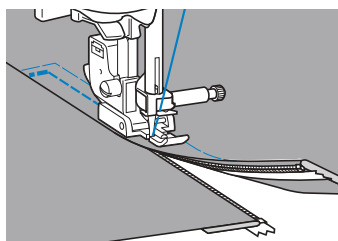

Zipper/piping Insertion

A zipper and piping can be sewn in place.

- Using the table below, refer to "Using the utility stitch tables in the "Sewing" section" in the "Basic operations" section.

| Stitch name | Stitch | Model 4 | Model 3, 2 | | Presser foot |
|------------------------|---|---------------|------------|---------|--------------|
| | | Stitch number | | Model 1 | |
| Straight stitch (Left) |  | 1-01 | 01* | 01* | ** |

* Stitch patterns can be selected directly by pressing the numeric keys on the machine during preset utility stitch mode. Refer to "Basic operations" section.

**Adjustable zipper/piping foot (sold separately with some models)

Inserting a centered zipper

- Refer to step 1–6 of "Inserting a centered zipper" on page S-19.
- Remove the presser foot and presser foot holder to attach the screw-on adjustable zipper/piping foot (sold separately with some models).
 - For details on removing the presser foot holder, refer to "Removing and attaching the presser foot holder" in the "Basic operations" section.

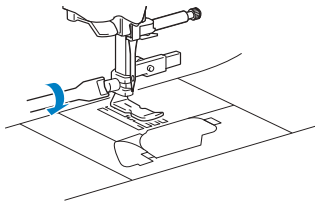

Note

- Make sure that the thread between the spool and the bobbin is pulled tight.

- Select stitch .
- Loosen the positioning screw on the back of the presser foot.

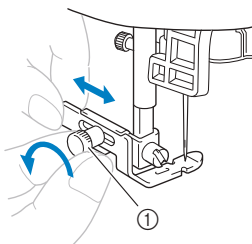

① Positioning screw

- Slide the presser foot over either the left or right feed dog.

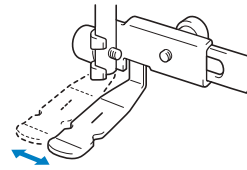

Left sewing position

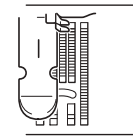

Right sewing position

- Change the needle position so that the needle does not touch the presser foot.

For details, refer to "Setting the stitch width" in the "Basic operations" section.



① Needle drop point

CAUTION

- After adjusting the needle position, slowly turn the handwheel toward you (counterclockwise) and check the needle does not touch the presser foot. If the needle hits the presser foot, the needle may bend or break.

- Securely tighten the positioning screw.

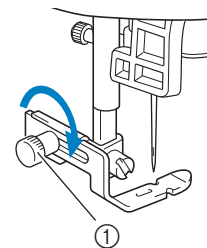

① Positioning screw

8 Topstitch around the zipper.

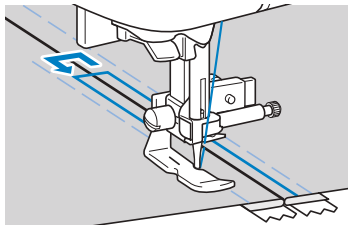
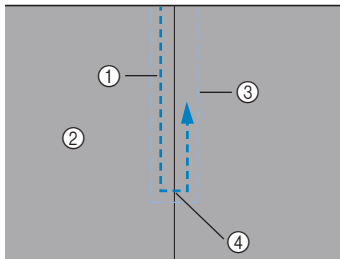

- ① Stitching
- ② Right side of fabric
- ③ Basting stitching
- ④ End of zipper opening

4 After sewing, turn them over.

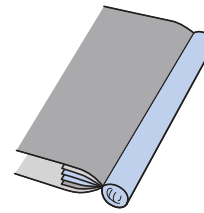

⚠ CAUTION

- When sewing, be sure that the needle does not touch the zipper, otherwise the needle may bend or break.

9 Remove the basting stitching.

Inserting a piping

1 Place the piping between two fabrics inside out, as shown below.

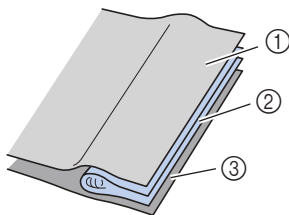

- ① Fabric
- ② Piping
- ③ Fabric



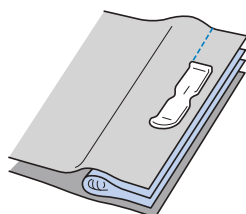

2 Refer to the steps of attaching the adjustable zipper/piping foot on the previous page.

3 Sew along the piping.



Sewing Stretch Fabrics and Elastic Tape

- Using the table below, refer to "Using the utility stitch tables in the "Sewing" section" in the "Basic operations" section.

| Stitch name | Stitch | Model 4 | Model 3, 2 | | Presser foot |
|-------------------------------|---|---------|------------|---------|--------------|
| | | | Model 3, 2 | Model 1 | |
| Stitch number | | | | | |
| Stem stitch |  | 1-06 | 06* | 06* | J |
| 2 steps elastic zigzag stitch |  | 1-13 | 13 | 11 | |
| 3 steps elastic zigzag stitch |  | 1-14 | 14* | 12* | |
| Tape attaching stitch |  | 2-13 | 48 | 42 | |

* Stitch patterns can be selected directly by pressing the numeric keys on the machine during preset utility stitch mode. Refer to "Basic operations" section.

Stretch stitching

- Attach zigzag foot "J".

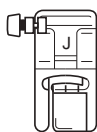

- Select stitch .

- Sew the fabric without stretching it.

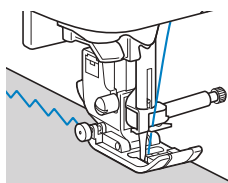

Elastic attaching

When elastic tape is attached to the cuff or waist of a piece of clothing, the finished dimensions will be that of the stretched elastic tape. Therefore, it is necessary that a suitable length of the elastic tape be used.

- Pin the elastic tape to the wrong side of the fabric.

Pin the elastic tape to the fabric at a few points to make sure that the tape is uniformly positioned on the fabric.

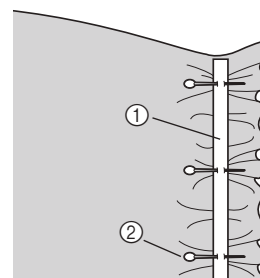

- ① Elastic tape
- ② Pin

- Attach zigzag foot "J".

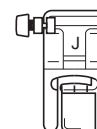

- Select a stitch.

- Sew the elastic tape to the fabric while stretching the tape so that it is the same length as the fabric.

While pulling the fabric behind the presser foot with your left hand, pull the fabric at the pin nearest the front of the presser foot with your right hand.

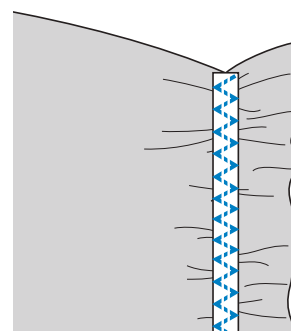
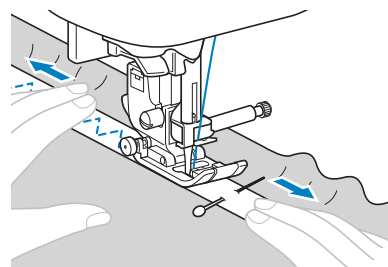













⚠ CAUTION

- When sewing, be sure that the needle does not touch any pins, otherwise the needle may bend or break.

Appliqué, Patchwork and Quilt Stitching

- Using the table below, refer to "Using the utility stitch tables in the "Sewing" section" in the "Basic operations" section.

| Stitch name | Stitch | Model 4 |  | | Presser foot |
|----------------------------------|---|---------------|---|---------|--------------|
| | | | Model 3, 2 | Model 1 | |
| | | Stitch number | | | |
| Zigzag stitch |  | 1-09 | 09* | 08* | J |
| Quilting appliqué zigzag stitch |  | 1-33 | 33 | 28 | |
| Blanket stitch |  | 2-03 | 38 | 33 | |
| Quilting appliqué stitch |  | 1-34 | 34 | 29 | |
| Piecing stitch (Right) |  | 1-29 | 29 | 25 | |
| Piecing stitch (Middle) |  | 1-30 | 30 | 26 | |
| Piecing stitch (Left) |  | 1-31 | 31 | - | |
| Patchwork join stitch |  | 2-07 | 42 | 36 | |
| Patchwork double overlock stitch |  | 2-08 | 43 | 37 | |
| Couching stitch |  | 2-09 | 44 | 38 | |
| Hand-look quilting stitch |  | 1-32 | 32 | 27 | |
| Quilting stippling stitch |  | 1-35 | 35 | 30 | |

* Stitch patterns can be selected directly by pressing the numeric keys on the machine during preset utility stitch mode. Refer to "Basic operations" section.



Memo

- Patterns showing a "Q" in the table above are for quilting and those showing a "P" are for piecing.

Appliqué stitching

- Cut out the appliqué, leaving a seam allowance of between 3 and 5 mm (1/8 and 3/16 inch).

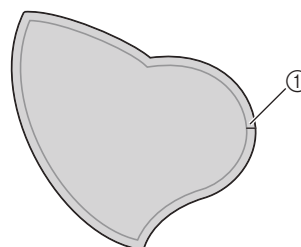

① Seam allowance

- Place a pattern made of thick paper or stabilizer on the back of the appliqué, and then fold over the seam allowance using an iron.

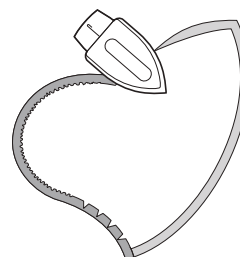

- Turn the fabric over, and then baste or fuse it onto the fabric that it will be attached to.

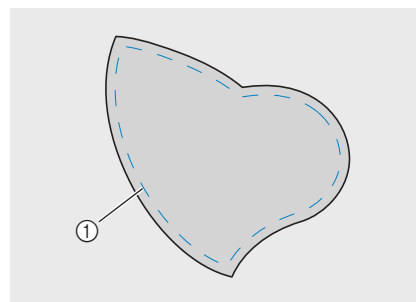

① Basting stitching

- Attach the zigzag foot "J" or the open toe foot (sold separately with some models) shown below.

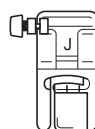

Zigzag foot "J"

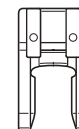

Open toe foot

- Select a stitch.

- Turn the handwheel toward you (counterclockwise), and then begin sewing around the edge of the appliqué, making sure that the needle drops just outside of the appliqué.

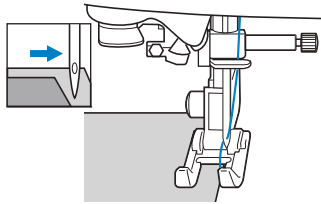

When sewing around corners, stop the machine with the needle in the fabric just outside of the appliqué, raise the presser foot lever, and then turn the fabric as needed to change the sewing direction.

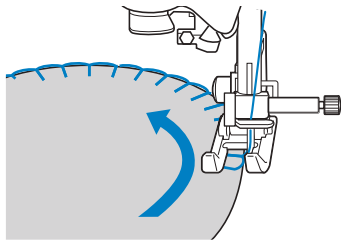

Patchwork (crazy quilt) stitching

- Fold the edge of the top piece of fabric and place it over the lower piece.
- Sew the two pieces of fabric together so the pattern spans over both pieces.

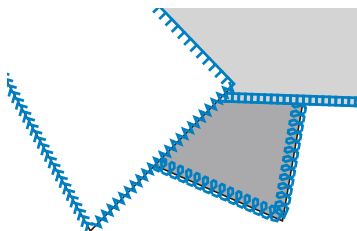
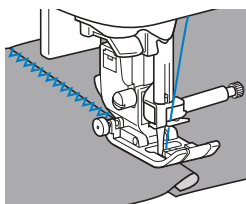



Piecing

Sewing together two pieces of fabric is called “piecing”. The fabric pieces should be cut with a 6.5 mm (1/4 inch) seam allowance.

Sew a piecing straight stitch 6.5 mm (1/4 inch) from either the right side or the left side of the presser foot.

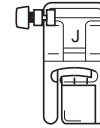
- Baste or pin along the seam allowance of the fabric that you wish to piece together.
- Attach zigzag foot “J”.



- Select stitch  or .
- Sew with the side of the presser foot aligned with the edge of the fabric.

■ For a seam allowance on the right side

Align the right side of the presser foot with the edge of the fabric, and sew using stitch .

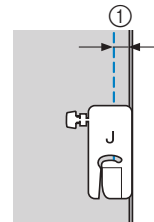

① 6.5 mm (1/4 inch)

■ For a seam allowance on the left side

Align the left side of the presser foot with the edge of the fabric, and sew using stitch .

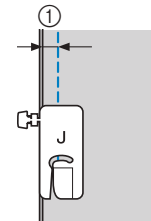

① 6.5 mm (1/4 inch)

Memo

- To change the width of the seam allowance (needle position), adjust the stitch width. For details, refer to “Setting the stitch width” in the “Basic operations” section.

■ Piecing using the 1/4" quilting foot with guide (sold separately with some models)

This quilting foot can sew an accurate 1/4 inch or 1/8 inch seam allowance.

It can be used for piecing together a quilt or for topstitching.

- 1 Press , and then attach the 1/4" quilting foot with guide.

- 2 Use the guide and marks on the presser foot to sew accurate seam allowances.

Piecing a 1/4 inch seam allowance

Sew keeping the edge of the fabrics against the guide.

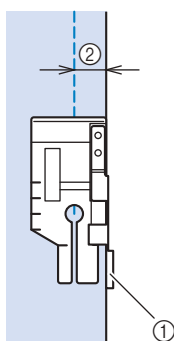

- ① Guide
- ② 1/4 inch

Creating an accurate seam allowance

Use the mark on the foot to begin, end, or pivot 1/4 inch from edge of fabric.

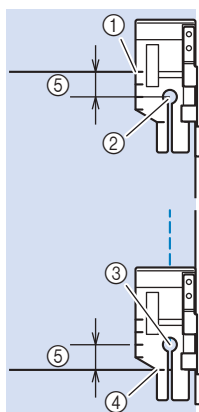

- ① Align this mark with edge of fabric to begin.
- ② Beginning of stitching
- ③ End of stitching
- ④ Opposite edge of fabric to end or pivot
- ⑤ 1/4 inch



Memo

- For details, refer to "Pivoting" in the "Basic operations" section.

■ Topstitching quilting, 1/8 inch

Sew with the edge of the fabric aligned with the left side of the presser foot end.

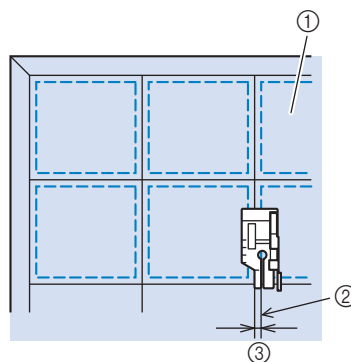



- ① Surface of fabric
- ② Seam
- ③ 1/8 inch

■ Using the 1/4" quilting foot (sold separately with some models)

If the 1/4" quilting foot is used, seams can be sewn with a seam allowance of 6.4 mm (1/4 inch).

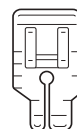
- 1 Baste or pin along the seam allowance of the fabric that you wish to piece together.
- 2 Attach the 1/4" quilting foot.



- 3 Select stitch .

- 4 Align the mark at the upper edge of the 1/4" quilting foot with the upper edge of the fabric.

Align the right edge of the fabric with the right edge of the narrow part of the 1/4" quilting foot.

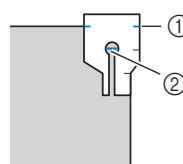

- ① Mark on 1/4" quilting foot
- ② Beginning of stitching

When sewing with a seam allowance, align the left edge of the narrow part of the 1/4" quilting foot with the fabric edge.

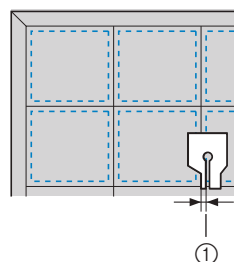

- ① Seam (3.2 mm (1/8 inch))

5 Start sewing.

6 When the end of the stitching is reached, stop the machine.

Sew until the mark at the lower edge of the 1/4" quilting foot aligns with the lower edge of the fabric.

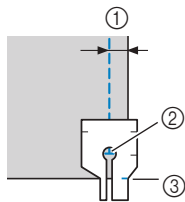

- ① 6.4mm (1/4 inch)
- ② End of stitching
- ③ Mark on 1/4" quilting foot

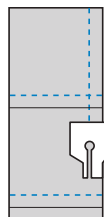

Quilting

Sandwiching batting between the top and bottom layers of fabric is called "quilting". Quilts can easily be sewn using the walking foot* and the quilting guide*.

* Sold separately with some models.

Note

- Thread the needle manually when using the walking foot, or only attach the walking foot after threading the needle using the needle threader.
- When sewing with the walking foot, sew at a speed between slow and medium.
- When quilting, use a 90/14 home machine needle.
- The walking foot can only be used with straight or zigzag stitch patterns. Reverse stitches cannot be sewn with the walking foot. Only select straight or zigzag stitch patterns with reinforcement stitches. For details, refer to "Stitch Setting Chart" in the "Basic operations" section.
- (For models equipped with Automatic Fabric Sensor System)
When "Automatic Fabric Sensor System" in the settings screen is set to "ON", the thickness of the fabric is automatically detected by the internal sensor so the fabric can be fed smoothly for best sewing results. For details on the automatic fabric sensor system, refer to "Automatic Fabric Sensor System (Automatic presser foot pressure)" in the "Basic operations" section.

1 Baste the fabric to be quilted.

2 Remove the presser foot and the presser foot holder.

- For details, refer to "Removing and attaching the presser foot holder" in the "Basic operations" section.

3 Hook the connecting fork of the walking foot onto the needle clamp screw.

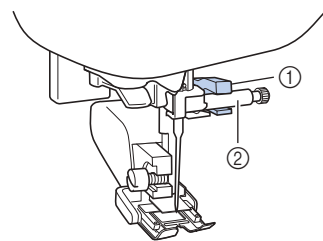

- ① Connecting fork
- ② Needle clamp screw

4 Lower the presser foot lever, insert the presser foot holder screw, and then tighten the screw with the screwdriver.

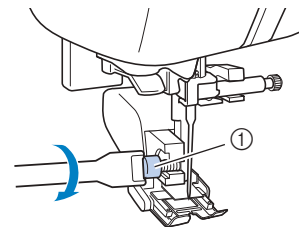

- ① Presser foot holder screw

CAUTION

- Be sure to securely tighten the screws with the screwdriver, otherwise the needle may touch the presser foot, causing it to bend or break.
- Before starting to sew, slowly turn the handwheel toward you (counterclockwise) and check that the needle does not touch the presser foot. If the needle hits the presser foot, the needle may bend or break.

5 Select a stitch.

6 Place one hand on each side of the presser foot, and then evenly guide the fabric while sewing.

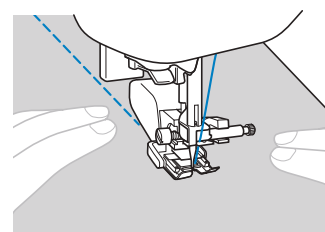

■ **Using the quilting guide (sold separately with some models)**

Use the quilting guide to sew parallel stitches that are equally spaced.

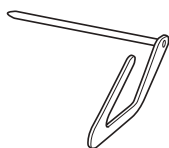

1 Insert the stem of the quilting guide into the hole at the rear of the walking foot or presser foot holder.

□ Walking foot

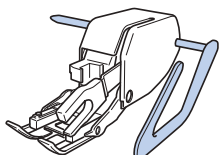

□ Presser foot holder

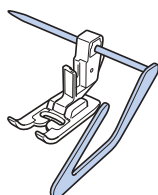

2 Adjust the stem of the quilting guide so that the guide aligns with the seam that has already been sewn.

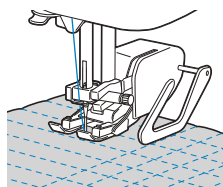

Free motion quilting

We recommend attaching the foot controller and sewing at a consistent speed. You can adjust the sewing speed with the speed control slide on the machine.

CAUTION

- With free motion quilting, control the feeding speed of the fabric to match the sewing speed. If the fabric is moved faster than the sewing speed, the needle may break or other damage may result.

Memo

- On models equipped with the free motion sewing mode, the presser foot can be adjusted to the best height for free motion sewing. For details, refer to “Sewing with free motion mode” in the “Basic operations” section.

■ **Using free motion open toe quilting foot “O”* or quilting foot***

* Sold separately with some models.

The free motion open toe quilting foot “O” or quilting foot is used for free motion quilting with zigzag or decorative stitches or for free motion quilting of straight lines on fabric with an uneven thickness. Various stitches can be sewn using free motion open toe quilting foot “O”. For details on the stitches that can be used, refer to “Stitch Setting Chart” in the “Basic operations” section.

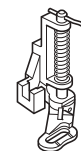
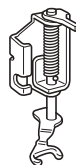

□ Free motion open toe quilting foot “O”

□ Quilting foot

1 Slide the feed dog position switch, located at the rear of the machine on the base, to (to the left as seen from the rear of the machine).

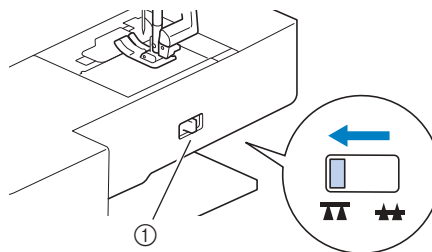

① Feed dog position switch (as seen from the rear of the machine)
→ The feed dogs are lowered.

2 Select a stitch.

3 Remove the presser foot holder.

- For details, refer to “Removing and attaching the presser foot holder” in the “Basic operations” section.

4 Attach free motion open toe quilting foot “O” by positioning the pin of the quilting foot above the needle clamp screw and aligning the lower-left of the quilting foot and the presser bar.

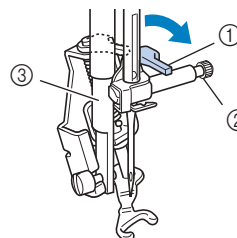

- ① Pin
- ② Needle clamp screw
- ③ Presser bar

Note

- Make sure that the quilting foot is not slanted.

- 5 Hold the quilting foot in place with your right hand, and tighten the presser foot holder screw using the screwdriver with your left hand.

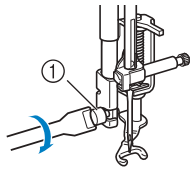

① Presser foot holder screw

⚠ CAUTION

- Be sure to securely tighten the screws with the included screwdriver. Otherwise, the needle may touch the quilting foot, causing it to bend or break.

- 6 Use both hands to stretch the fabric taut, and then move the fabric at a consistent pace in order to sew uniform stitches roughly 2.0 mm - 2.5 mm (approx. 1/16 inch - 3/32 inch) in length.

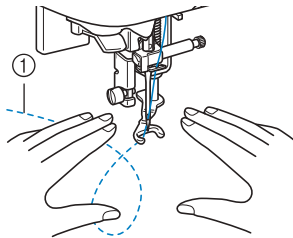

① Stitch

- 7 After sewing is finished, slide the feed dog position switch lever to **▲▲** (to the right as seen from the rear of the machine) and turn the handwheel to raise the feed dogs.

📖 Memo

- Do not be discouraged with your initial results. The technique requires practice.

■ Using free motion quilting foot “C” (sold separately with some models)

Use the free motion quilting foot “C” with straight stitch needle plate for free motion sewing.

- Free motion quilting foot “C”



⚠ CAUTION

- When using free motion quilting foot “C”, be sure to use the straight stitch needle plate and sew with the needle in middle (center) needle position. If the needle is moved to any position other than the middle (center) needle position, the needle may break, which may result in injuries.

📖 Memo

- On models equipped with the free motion sewing mode, the presser foot can be adjusted to the best height for free motion sewing. For details, refer to “Sewing with free motion mode” in the “Basic operations” section.

- 1 Attach the straight stitch needle plate (sold separately with some models).

- For details on attaching the straight stitch needle plate, refer to operation manual supplied with the product.

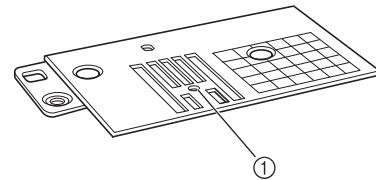

① Round hole

📖 Memo

- Notice this needle plate has a round hole for the needle.

- 2 Slide the feed dog position switch, located at the rear of the machine on the base, to **▲▲** (to the left as seen from the rear of the machine).

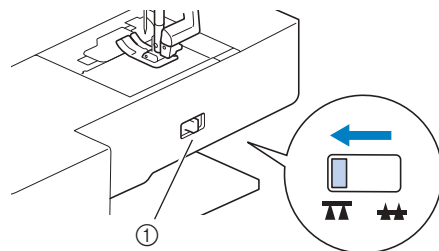

① Feed dog position switch (as seen from the rear of the machine)

→ The feed dogs are lowered.

- 3 Select **i.p.**

- 4 Remove the presser foot holder.

- For details, refer to “Removing and attaching the presser foot holder” in the “Basic operations” section.

- 5** Attach free motion quilting foot “C” at the front with the presser foot holder screw aligned with the notch in the quilting foot.

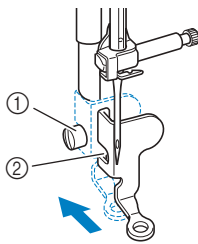

- ① Presser foot holder screw
- ② Notch



Note

- Make sure that the quilting foot is attached properly and not slanted.

- 6** Hold the quilting foot in place with your right hand, and tighten the presser foot holder screw using the screwdriver with your left hand.

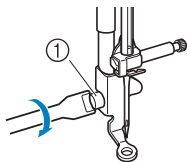

- ① Presser foot holder screw

⚠ CAUTION

- Be sure to securely tighten the screws with the included screwdriver. Otherwise, the needle may touch the quilting foot, causing it to bend or break.

- 7** Use both hands to stretch the fabric taut, and then move the fabric at a consistent pace in order to sew uniform stitches roughly 2.0 mm - 2.5 mm (approx. 1/16 inch - 3/32 inch) in length.

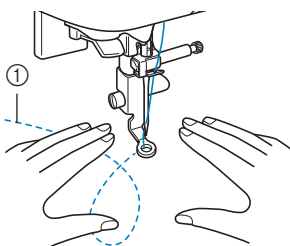

- ① Stitch

- 8** After sewing is finished, slide the feed dog position switch lever to **▲▲** (to the right as seen from the rear of the machine) and turn the handwheel to raise the feed dogs.



Note

- Free motion open toe quilting foot “O” can also be used with the straight stitch needle plate. We recommend using free motion open toe quilting foot “O” with free motion sewing of fabrics of uneven thicknesses.
- When using the straight stitch needle plate, all straight stitches become middle needle position stitches. You cannot change the needle position using the width display.



Memo

- Do not be discouraged with your initial results. The technique requires practice.

■ Echo quilting using the free motion echo quilting foot “E” (sold separately with some models)

Sewing quilting lines at equal distances around a motif is called echo quilting. The quilting lines, which appear as ripples echoing away from the motif, are the distinguishing characteristic of this quilting style. Use the optional free motion echo quilting foot “E” for echo quilting. Using the measurement on the presser foot as a guide, sew around the motif at a fixed interval. We recommend attaching the foot controller and sewing at a consistent speed.

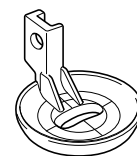

Free motion echo quilting foot “E” measurement

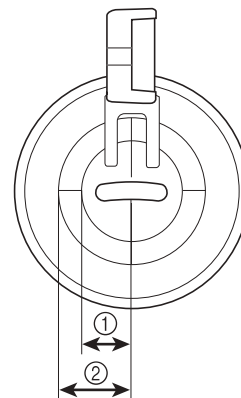

- ① 6.4 mm (approx. 1/4 inch)
- ② 9.5 mm (approx. 3/8 inch)

⚠ CAUTION

- With free motion quilting, control the feeding speed of the fabric to match the sewing speed. If the fabric is moved faster than the sewing speed, the needle may break or other damage may result.

📖 Memo

- On models equipped with the free motion sewing mode, the presser foot can be adjusted to the best height for free motion sewing. For details, refer to “Sewing with free motion mode” in the “Basic operations” section.

- 1 Slide the feed dog position switch, located at the rear of the machine on the base, to  (to the left as seen from the rear of the machine).

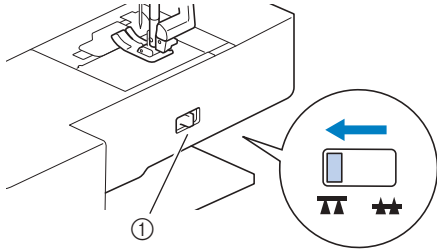

① Feed dog position switch (as seen from the rear of the machine)

→ The feed dogs are lowered.

- 2 Select .

- 3 Remove the presser foot holder (see the “Basic operations” section) and the screw.

- 4 Position the free motion echo quilting foot “E” on the left side of the presser bar with the holes in the quilting foot and presser bar aligned.

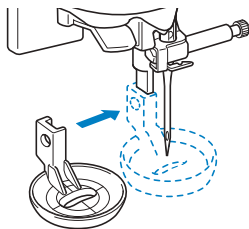

- 5 Tighten the screw with the included screwdriver.

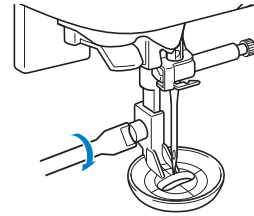
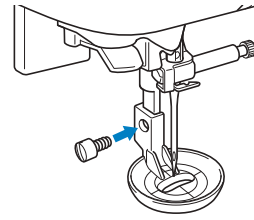

⚠ CAUTION

- Be sure to securely tighten the screws with the included screwdriver. Otherwise, the needle may touch the quilting foot, causing it to bend or break.

- 6 Using the measurement on the quilting foot as a guide, sew around the motif.

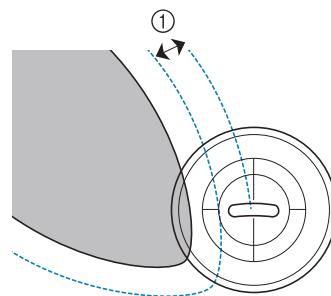
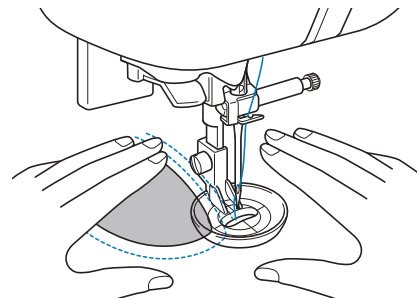

① 6.4 mm (approx. 1/4 inch)

Finished project

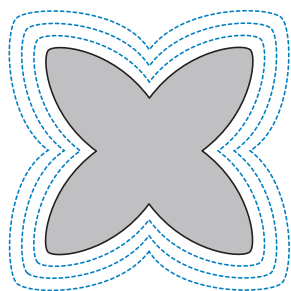

- After sewing is finished, slide the feed dog position switch lever to (to the right as seen from the rear of the machine) and turn the handwheel to raise the feed dogs.

Satin stitching using the sewing speed controller

A decorative stitch can be sewn by changing the stitch width of a satin stitch. If the machine is set so that the stitch width can be adjusted using the sewing speed controller, the stitch width can quickly and easily be adjusted. In this case, the sewing speed is adjusted with the foot controller.

- Connect the foot controller.
- Attach zigzag foot "J".

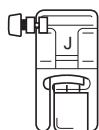

- Press to display the settings screen, and set "Width Control" to "ON".

The settings screens differ depending on the models.

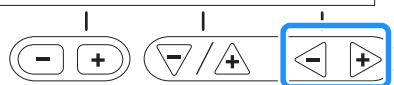
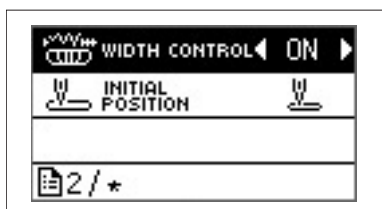

→ The machine is now set so that the stitch width can be controlled with the sewing speed controller.

- Press .

- Select stitch .

- While sewing, slide the sewing speed controller to adjust the stitch width.

Slide the controller to the left to make the width narrower. Slide the controller to the right to make the width wider.

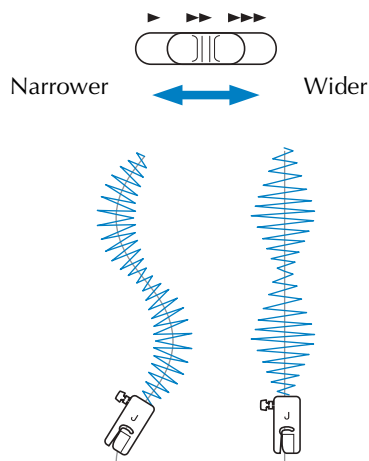

- Adjust the sewing speed with the foot controller.

- When you are finished sewing, set the stitch width control setting back to "OFF".





Memo

- Although the stitching result differs depending on the type of fabric being sewn and the thickness of the thread being used, for best results, adjust the stitch length to between 0.3 and 0.5 mm (1/64 and 1/32 inch).

Reinforcement Stitching

Reinforce points that will be subject to strain, such as sleeve holes, inseams and pocket corners.

- Using the table below, refer to "Using the utility stitch tables in the "Sewing" section" in the "Basic operations" section.

| Stitch name | Stitch | Model 4 | Model 3, 2 | | Presser foot |
|-----------------------|---|---------|------------|---------|--------------|
| | | | Model 3, 2 | Model 1 | |
| Stitch number | | | | | |
| Triple stretch stitch |  | 1-05 | 05* | 05* | J |
| Bar tack stitch |  | 4-13 | 89 | 69 | A |
| Darning stitch |  | 4-11 | 87 | 67 | |
| |  | 4-12 | 88 | 68 | |

* Stitch patterns can be selected directly by pressing the numeric keys on the machine during preset utility stitch mode. Refer to "Basic operations" section.

Triple stretch stitching

Use triple stretch stitching to reinforce sleeve holes and inseams.

- 1 Attach zigzag foot "J".

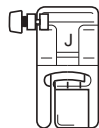

- 2 Select stitch .

- 3 Start sewing.

Bar tack stitching

Bar tacks are used to reinforce points subject to strain, such as pocket corners and openings.

As an example, the procedure for sewing bar tacks at pocket corners is described below.

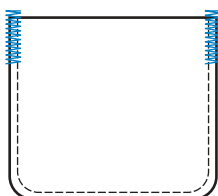

- 1 Determine the desired length of the bar tack.

Set the button guide plate on buttonhole foot "A" to the desired length. (The distance between the markings on the presser foot scale is 5 mm (3/16 inch).)

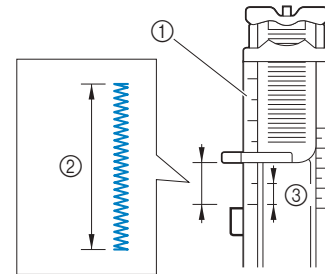

- 1 Presser foot scale
- 2 Length of bar tack
- 3 5 mm (3/16 inch)

- A bar tack with a maximum length of about 28 mm (1-1/8 inches) can be sewn.

- 2 Attach buttonhole foot "A".

- 3 Select stitch .

- 4 Position the fabric so that the opening of the pocket faces toward you, and then lower the presser foot lever so that the needle drops 2 mm (1/16 inch) in front of the pocket opening.

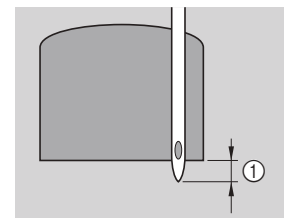

- 1 2 mm (1/16 inch)

Pass the upper thread down through the hole in the presser foot.

- When lowering the presser foot, do not push in the front of the presser foot, otherwise the bar tack will not be sewn with the correct size.

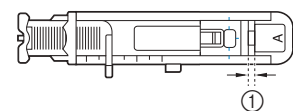
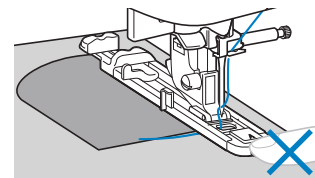

- 1 Do not reduce the gap.

- 5 Pull down the buttonhole lever as far as possible.**

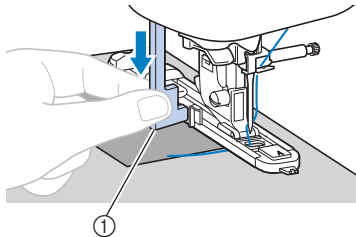

- ① Buttonhole lever
The buttonhole lever is positioned behind the bracket on the buttonhole foot.

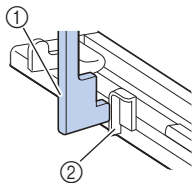

- ① Buttonhole lever
② Bracket

- 6 Gently hold the end of the upper thread in your left hand, and then start sewing.**

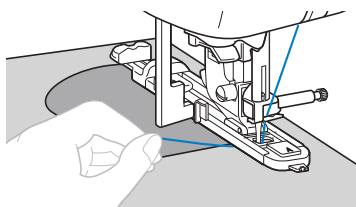

- 7 Raise the presser foot lever, remove the fabric, and then cut the threads.**

- 8 Raise the buttonhole lever to its original position.**

Memo

- If the fabric does not feed, for example, because it is too thick, increase the stitch length. For details, refer to “Setting the stitch length” in the “Basic operations” section.

Darning

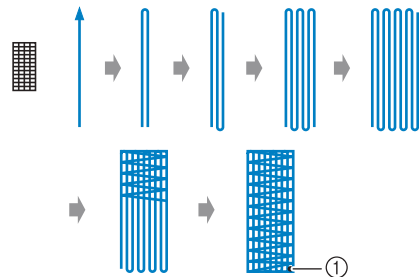
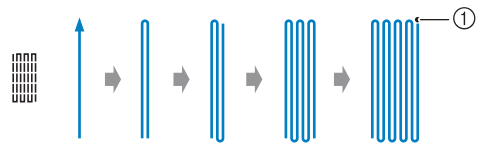

- ① Reinforcement stitching

- 1 Determine the desired length of the darning.**

Set the button guide plate on buttonhole foot “A” to the desired length. (The distance between the markings on the presser foot scale is 5 mm (3/16 inch).)

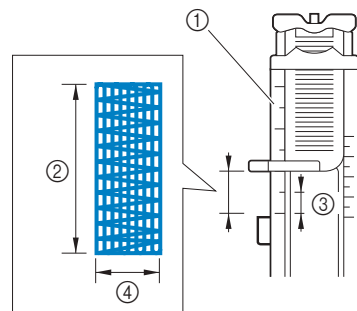

- ① Presser foot scale
② Length of darning
③ 5 mm (3/16 inch)
④ 7 mm (1/4 inch)

- A bar tack with a maximum length of about 28 mm (1-1/8 inches) can be sewn.

→ Once sewing is completed, the machine automatically sews reinforcement stitches, then stops.

- 2 Attach buttonhole foot “A”.**

- 3 Select stitch**  **or** .

- 4** Position the fabric so that the needle is 2 mm (1/16 inch) in front of the area to be darned.

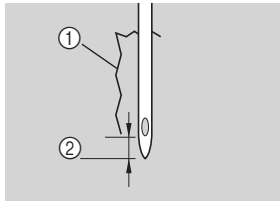

- ① Tear
② 2 mm (1/16 inch)

Pass the upper thread down through the hole in the presser foot, and then lower the presser foot.

- When lowering the presser foot, do not push in the front of the presser foot, otherwise the darning will not be sewn with the correct size.

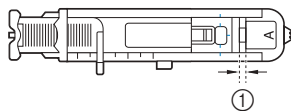
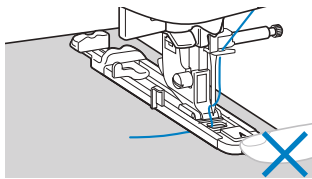

- ① Do not reduce the gap.

- 5** Pull down the buttonhole lever as far as possible.

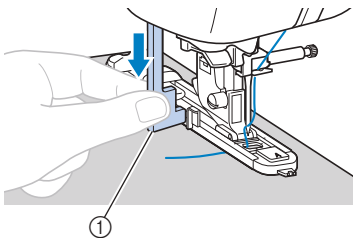

- ① Buttonhole lever
The buttonhole lever is positioned behind the bracket on the buttonhole foot.

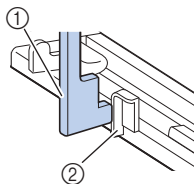

- ① Buttonhole lever
② Bracket

- 6** Gently hold the end of the upper thread in your left hand, and then start sewing.

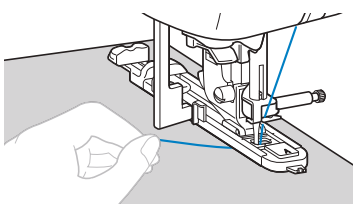

- 7** Raise the presser foot lever, remove the fabric, and then cut the threads.

- 8** Raise the buttonhole lever to its original position.



Memo

- If the fabric does not feed, for example, because it is too thick, increase the stitch length. For details, refer to "Setting the stitch length" in the "Basic operations" section.

Eyelet Stitching

Eyelets, such as those on belts, can be sewn.

- Using the table below, refer to "Using the utility stitch tables in the "Sewing" section" in the "Basic operations" section.

| Stitch name | Stitch | Model 4 | Model 3, 2 | | Model 1 | Presser foot |
|---------------|---|---------|---------------|----|---------|--------------|
| | | | Stitch number | | | |
| Eyelet stitch |  | 4-15 | 91 | 71 | N | |

- Attach monogramming foot "N".

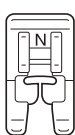

- Select stitch .

- Adjust either the stitch width or the stitch length to select the desired eyelet size.

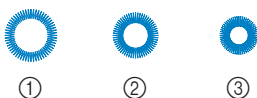

- ① 7mm
- ② 6mm
- ③ 5mm

- For details, refer to "Setting the stitch width" and "Setting the stitch length" in the "Basic operations" section.

- Lower the needle into the fabric at the beginning of the stitching, and then lower the presser foot lever.

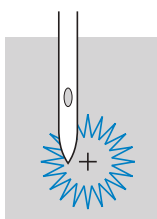

- Start sewing.

→ Once sewing is completed, the machine automatically sews reinforcement stitches, then stops.

- Use the eyelet punch to cut a hole in the center of the eyelet.

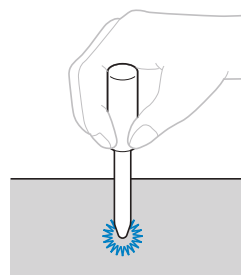

- When using the eyelet punch, place thick paper or some other protective sheet under the fabric before punching the hole in the fabric.

Memo

- If thin thread is used, the stitching may be too open. If this occurs, sew the eyelet twice before removing the fabric, one on top of the other.

Attaching Patches or Emblems to Shirt Sleeves

Use these stitch patterns to attach patches or emblems to pant legs, shirt sleeves, etc.

- Using the table below, refer to "Using the utility stitch tables in the "Sewing" section" in the "Basic operations" section.

| Stitch name | Stitch | Model 4 | Model 3, 2 | | Presser foot |
|-------------------------------------|--------|---------|------------|---------|--------------|
| | | | Model 3, 2 | Model 1 | |
| Stitch number | | | | | |
| Reverse (Straight stitch) | ↑ | 5-01 | 92 | — | N |
| Sideways to left (Straight stitch) | ← | 5-02 | 93 | — | |
| Sideways to right (Straight stitch) | → | 5-03 | 94 | — | |
| Forward (Straight stitch) | ↓ | 5-04 | 95 | — | |
| Sideways to left (Zigzag stitch) | ↔ | 5-05 | 96 | — | |
| Sideways to right (Zigzag stitch) | ↔ | 5-06 | 97 | — | |
| Forward (Zigzag stitch) | ↕ | 5-07 | 98 | — | |
| Reverse (Zigzag stitch) | ↕ | 5-08 | 99 | — | |

Insert the tubular piece of fabric onto the free-arm, and then sew in the order shown in the illustration.

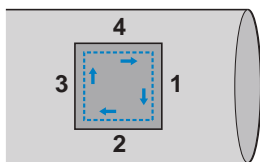

- Remove the flat bed attachment.
- Attach monogramming foot "N".

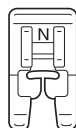

- Select stitch ↓.

- Lower the needle into the fabric at the beginning of the stitching, and then start sewing.

Lower the needle at the upper-right corner.

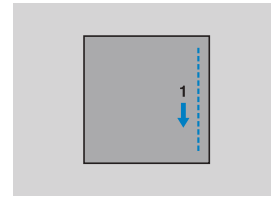

→ The fabric is fed toward the back of the machine, as usual.

- After you have sewn to the corner, stop the machine, and then select stitch ←.

- Start sewing.

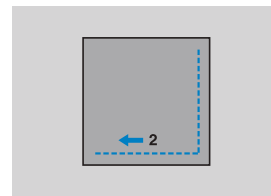

→ The fabric is fed to the right.

- After you have sewn to the corner, stop the machine, and then select stitch ↑.

- Start sewing.

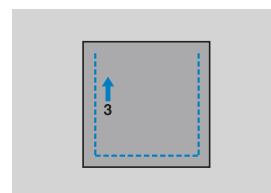

→ The fabric is fed forward.

- After you have sewn to the corner, stop the machine, and then select stitch →.

- Start sewing.

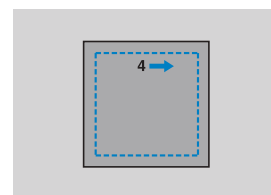

→ The fabric is fed to the left.

S
UTILITY STITCHES

11 After you have sewn to the corner, stop the machine, and then select stitch  again.

12 After sewing 3 to 5 stitches at the beginning of the stitching, stop the machine.























Memo

- The feeding direction of the fabric differs depending on the stitch that is selected. Be sure to guide the fabric while machine is sewing.
-

Decorative Stitching

The utility stitches contain the following decorative stitches.

- Using the table below, refer to “Using the utility stitch tables in the “Sewing” section” in the “Basic operations” section.

| Stitch name | Stitch | Model 4 | Stitch number | | Presser foot |
|----------------------------------|---|---------|---------------|---------|--------------|
| | | | Model 3, 2 | Model 1 | |
| Patchwork join stitch |  | 2-07 | 42 | 36 | J |
| Patchwork double overlock stitch |  | 2-08 | 43 | 37 | |
| Couching stitch |  | 2-09 | 44 | 38 | |
| Shell tuck edge stitch |  | 2-04 | 39 | 34 | |
| Smocking stitch |  | 2-10 | 45 | 39 | |
| Feather stitch |  | 2-11 | 46 | 40 | |
| Fagoting cross stitch |  | 2-12 | 47 | 41 | |
| Satin scallop stitch |  | 2-05 | 40 | 35 | N |
| Hemstitching |  | 3-04 | 58 | 48 | |
| |  | 3-06 | 60 | 50 | |
| |  | 3-09 | 63 | – | |
| |  | 3-10 | 64 | 52 | |
| Honeycomb stitch |  | 3-12 | 66 | – | |
| Hemstitching |  | 3-18 | 72 | 56 | |
| |  | 3-20 | 74 | – | |
| |  | 3-21 | 75 | – | |
| |  | 3-22 | 76 | – | |
| Ladder stitch |  | 2-14 | 49 | 43 | J |
| Rick-rack stitch |  | 2-15 | 50 | 44 | |
| Decorative stitch |  | 2-16 | 51 | 45 | |
| Serpentine stitch |  | 2-17 | 52 | 46 | |

Fagoting

Stitching across an open seam is called “fagoting”. It is used on blouses and children's clothing. This stitch is more decorative when thicker thread is used.

- Use an iron to fold the two pieces of fabric along their seams.
- Baste the two pieces of fabric, separated by about 4 mm (3/16 inch), onto thin paper or a sheet of water-soluble stabilizer.

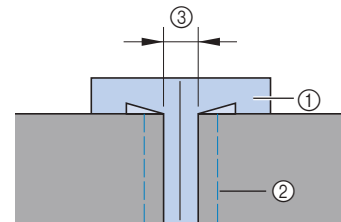

If you draw a line down the middle of the thin paper or water-soluble stabilizer, sewing is easier.

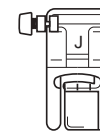

- Thin paper or water soluble stabilizer
- Basting stitching
- 4 mm (3/16 inch)

- Attach zigzag foot “J”.



- Select stitch  or .
- Set the stitch width to 7.0 mm (1/4 inch).
- Sew with the center of the presser foot aligned along the center of the two pieces of fabric.

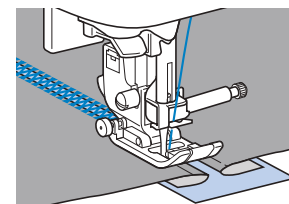
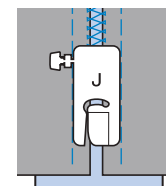



- After sewing is finished, remove the paper.

Scallop stitching

The wave-shaped repeated pattern that looks like shells is called “scalloping”. It is used on the collars of blouses and to decorate the edges of projects.

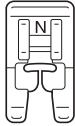
- 1 Attach monogramming foot “N”.



- 2 Select stitch .

- 3 Stitch along the edge of the fabric, making sure not to sew directly on the edge of the fabric.

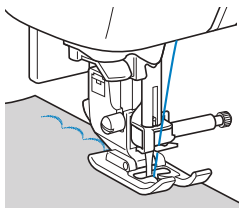

- For better results, apply spray starch onto the fabric and press with a hot iron before it is sewn.

- 4 Trim along the stitches.

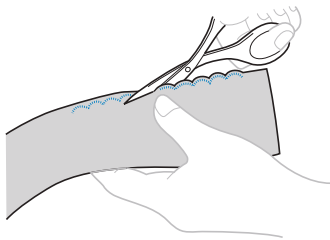

- Be careful not to cut the stitches.

Smocking

The decorative stitch created by stitching or embroidering over gathers is called “smocking”. It is used to decorate the front of blouses or cuffs.

The smocking stitch adds texture and elasticity to fabric.

- 1 Attach zigzag foot “J”.

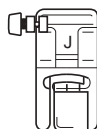

- 2 Select the straight stitch, and then adjust the stitch length to 4.0 mm (3/16 inch) and loosen the thread tension.

- For details, refer to “Setting the stitch length” and “Setting the thread tension” in the “Basic operations” section.
- For details, refer to “Pulling up the bobbin thread” in the “Basic operations” section.

- 3 Sew parallel stitching at intervals of 1 cm (3/8 inch).

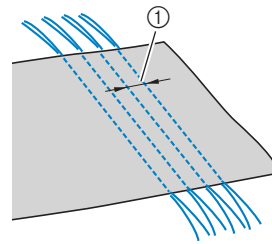

- ① 1 cm (3/8 inch)

- Do not use reverse/reinforcement stitching or thread cutting.
- At the end of the stitching, the thread is pulled out about 5 cm (2 inches).

- 4 Pull the bobbin threads to create gathers. Smooth the gathers by ironing them.

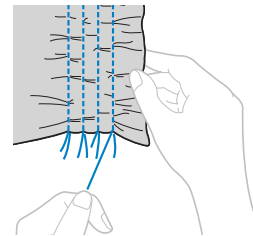

- 5 Select stitch , , or .

- 6 Stitch between the straight stitches.

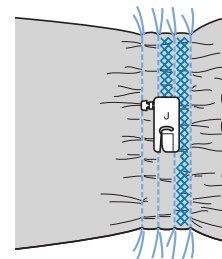

- 7 Pull out the threads for the straight stitches.

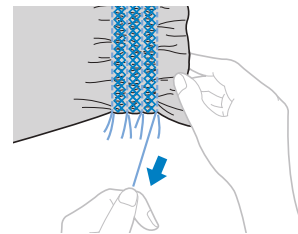

Shell tuck stitching

The gathers that look like shells are called “shell tucks”. They are used to decorate trims, the front of blouses or cuffs made of thin fabrics.

- 1 Fold the fabric along the bias.

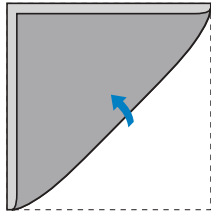

- 2 Attach zigzag foot “J”.

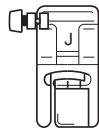

- 3 Select stitch , and then increase the thread tension.

- 4 Sew while making sure that the needle drops slightly off the edge of the fabric.

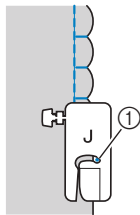

- 1 Needle drop point

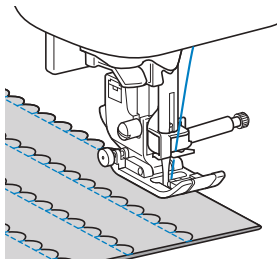

- 5 Unfold the fabric, and then iron the tucks down to one side.

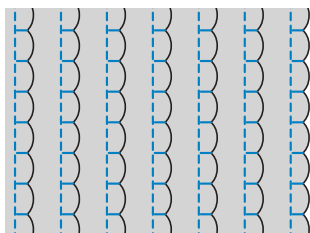

Joining

Decorative bridging stitches can be sewn over the seam allowance of joined fabrics. This is used when making a crazy quilt.

- 1 Attach zigzag foot “J”.

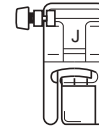

- 2 Sew together the right sides of the two pieces of fabric, and then open up the seam allowances.

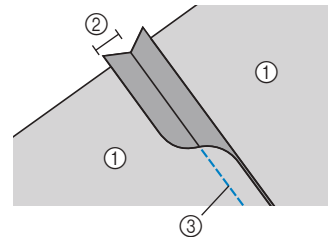

- 1 Wrong side of fabric
- 2 7 mm (1/4 inch) seam allowance
- 3 Straight stitch

- 3 Select stitch ,  or .

- 4 Turn the fabric over so that the right side faces up, and then sew over the seam with the center of the presser foot aligned with the seam.

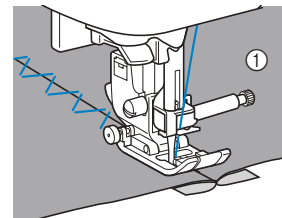

- 1 Right side of fabric

Heirloom stitching

When sewing with the wing needle, the needle holes are enlarged, creating a lace-like decorative stitch. This is used to decorate hems and tablecloths on thin or mediumweight fabrics in addition to plain weave fabrics.

1 Install the wing needle.



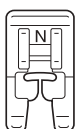

- Use a 130/705H 100/16 wing needle.
- For details on installing a needle, refer to “Replacing the Needle” in the “Basic operations” section.
- The needle threader cannot be used with the wing needle, otherwise the machine may be damaged. Manually pass the thread through the eye of the needle from the front to the back. For details, refer to “Threading the needle manually (without using the needle threader)” in the “Basic operations” section.

2 Attach monogramming foot “N”.



3 Select a stitch.

The stitches that can be used are 
 or .

- When sewing with the wing needle, select a stitch width of 6.0 mm (15/64 inch) or less.

4 Start sewing.

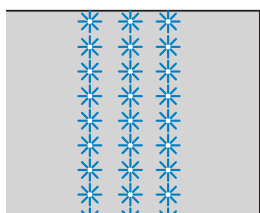

⚠ CAUTION

- When sewing with the wing needle, select a stitch width of 6.0 mm (15/64 inch) or less, otherwise the needle may bend or break.
- After adjusting the stitch width, slowly turn the handwheel toward you (counterclockwise) and check that the needle does not touch the presser foot. If the needle hits the presser foot, the needle may bend or break.

Partially removing threads is called “drawnwork”. This gives beautiful results with fabrics that have a loose weave.

Two ways to create drawnwork are described below.

■ Drawnwork (Example 1)

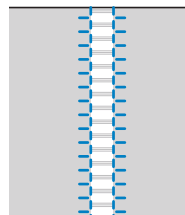

1 Pull out several threads from the fabric.

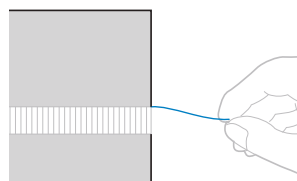

2 Attach monogramming foot “N”.

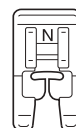

3 Select stitch .

4 With the right side of the fabric facing up, sew along the right edge of the frayed section.

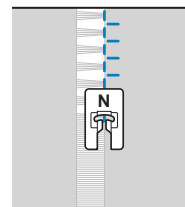

5 Press the mirror image key.

- For details, refer to “Mirroring stitches” in the “Basic operations” section.
 → The pattern displayed on the screen is mirrored.

6 Sew along the other edge of the frayed section so that it looks like the previous stitching.

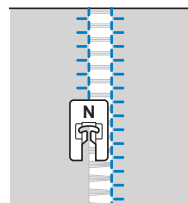

7 Press the mirror image key again to return to normal mode.

■ Drawnwork (Example 2)

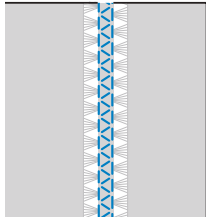

- 1 Pull out several threads from two sections of the fabric, separated by an unfrayed section of about 4 mm (3/16 inch).

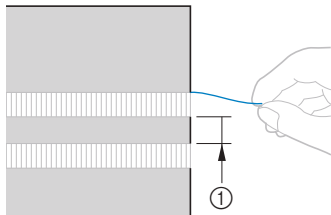

① 4 mm (3/16 inch)

- 2 Attach monogramming foot "N".

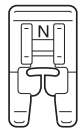

- 3 Select stitch .

- 4 Sew along the center of the unfrayed section.

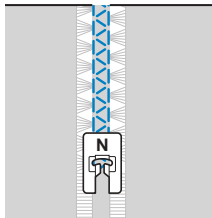

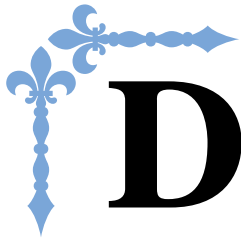

Decorative sewing

This section provides instructions on sewing character stitches and decorative stitches as well as on adjusting and editing them. In addition, it describes how to use MY CUSTOM STITCH, which allows you to create original stitch patterns.
Page number starts with “D” in this section.

Chapter1 CHARACTER / DECORATIVE STITCHESD-2

Chapter2 MY CUSTOM STITCHD-19

CAUTION

- Before replacing the presser foot, be sure to press  (Presser foot/Needle exchange key) on the operation panel to lock all keys and buttons, otherwise injuries may occur if the “Start/Stop” button or any other button is pressed and the machine starts. For details on changing the presser foot, refer to “Replacing the Presser Foot” in the “Basic operations” section.

Chapter 1 CHARACTER / DECORATIVE STITCHES

Selecting Stitch Patterns

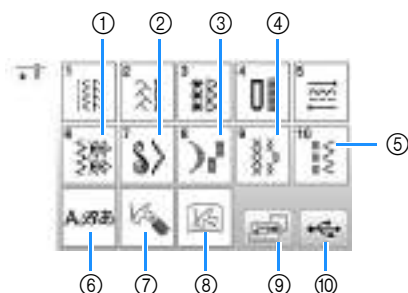

- ① Decorative stitches
- ② Satin stitches
- ③ 7 mm satin stitches
- ④ Cross stitch stitches
- ⑤ Utility decorative stitch patterns
- ⑥ Characters (Gothic font, Handwriting font, Outline, Cyrillic font, Japanese font)
- ⑦ Press this key to create your own stitches with the MY CUSTOM STITCH function (page D-19)
- ⑧ Patterns stored in MY CUSTOM STITCH (page D-24)
- ⑨ Patterns saved in the machine's memory (page D-17)
- ⑩ Patterns saved in USB flash drive (page D-17)

Selecting decorative stitch patterns/satin stitch patterns/7 mm satin stitch patterns/cross stitch/utility decorative stitch patterns

- 1 Select the category of the pattern you want to sew.



- 2 Press the key of the stitch pattern you want to sew.

Use ◀ or ▶ to display the previous/next page.

- To select a different stitch pattern, press . When the current stitch pattern is erased, select the new stitch pattern.

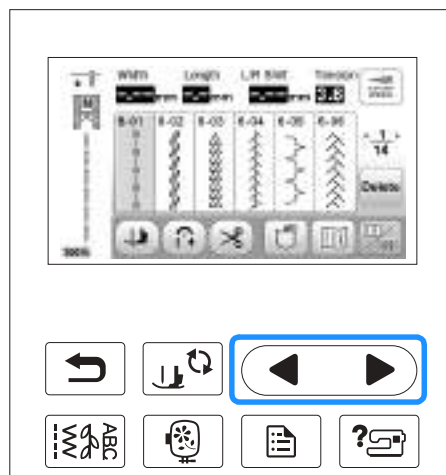

Characters

- **Example:** Entering "Blue Sky".

- 1 Press .



- 2 Press , , , or to select a font.



- Press a tab to change the selection screens.

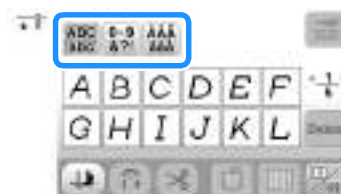

3 Press and then enter "B".



4 Press / to display "l", "u" and "e", and enter them.

5 Press two times and press to enter a space.



6 Press two times and enter "S".



- ① —
- ① Space is a jump stitch

- Remove the jump stitches after sewing.

7 Press to display "k" and "y", and enter them.

- If you want to continue entering characters in a different font, press , and then repeat from step 1.

■ Deleting characters

1 Press to delete the last character entered.



Memo

- Characters are deleted individually starting with the last character entered.

2 Select the correct character.

- Continually press and all characters will be deleted.



■ Adjusting the character spacing

The space between the characters can be adjusted.

1 Press , and then press .



→ The character spacing window appears.

2 Press or to adjust character spacing.

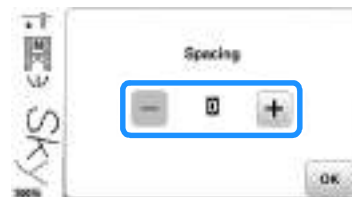

- **Example:** Each setting equals a specific distance between characters.

Value: 0

Blue Sky

Value: 10

Blue Sky

| Value | mm |
|-------|------|
| 0 | 0 |
| 1 | 0.18 |
| 2 | 0.36 |
| 3 | 0.54 |
| 4 | 0.72 |
| 5 | 0.9 |
| 6 | 1.08 |
| 7 | 1.26 |
| 8 | 1.44 |
| 9 | 1.62 |
| 10 | 1.8 |

Memo

- The default setting is "0". No number less than "0" can be set.
- Changing character spacing by this method, pertains to all characters. Spacing changes are valid not only while entering characters but also before and after the entering of characters.

Sewing Stitch Patterns

Sewing attractive finishes

To achieve attractive results when sewing character/decorative stitches, check the table below for the proper fabric/thread/needle combinations.

 **Note**

- Other factors, such as fabric thickness, stabilizer material, etc., also have an effect on the stitch, so you should always sew a few trial stitches before beginning your project.
- It may be necessary to adjust the pattern, depending on the type of fabric being sewn or the sewing speed. Adjust the pattern while sewing trial stitches on a scrap piece of fabric that is the same as what is used in your project. Refer to “Making adjustments” on page D-5.
- When sewing satin stitch patterns, there may be shrinking or bunching of stitches, so be sure to attach a stabilizer material.
- Guide the fabric with your hand to keep the fabric feeding straight and even during sewing.

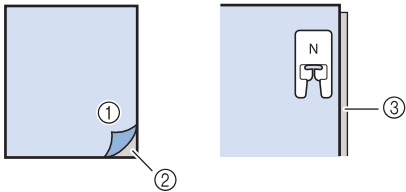
| | |
|--------------|--|
| Fabric | When sewing on stretch fabrics, lightweight fabrics, or fabrics with coarse weaves, attach stabilizer on the wrong side of the fabric. An alternative would be to, place the fabric on thin paper such as tracing paper. |
| |  <p>① Fabric ② Stabilizer ③ Thin paper</p> |
| Thread | #50 - #60 |
| Needle | With lightweight, regular, or stretch fabrics: the Ball point needle (golden colored) 90/14 With heavyweight fabrics: home machine needle 90/14 |
| Presser foot | Monogramming foot “N”. Using zigzag foot “J” or other presser feet may give inferior results. |
| Twin needle | You can sew with twin needle (2.0/11) when you select a 7 mm satin stitch pattern. In this case, use zigzag foot “J”. |

Basic sewing

- 1 Select a decorative/character stitch pattern.
- 2 Attach monogramming foot “N”.
- 3 Place the fabric under the presser foot, pull the upper thread out to the side, press  (Needle position button) to lower needle into fabric and then lower the presser foot.

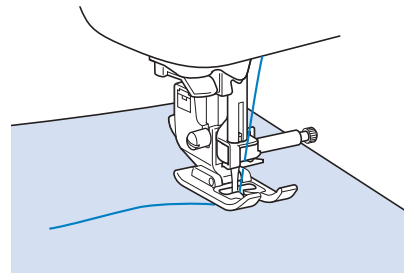

- 4 Press the “Start/Stop” button to begin sewing.

CAUTION

- When sewing 7 mm satin stitch patterns and the stitches are bunched, lengthen the stitch length. If you continue sewing when the stitches are bunched, the needle may bend or break. For details on adjusting the stitch length, refer to “Setting the stitch length” in the “Basic operations” section.

 **Memo**

- If the fabric is pulled or pushed during sewing, the pattern may not turn out correctly. Also, depending on the pattern, there may be movement to the left and right as well as front and back. Guide the fabric with your hand to keep the fabric feeding straight and even during sewing.

- 5 Press the “Start/Stop” button to stop sewing.

- 6 Press  (Reverse stitch button) or  (Reinforcement stitch button) to sew reinforcement stitches.

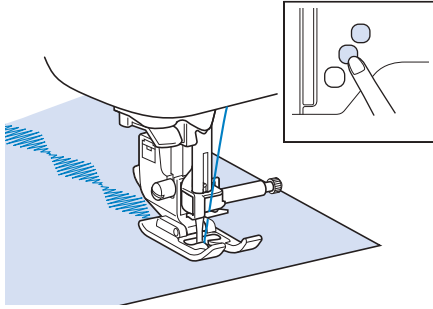

Memo

- When sewing character stitches, the machine automatically sews reinforcement stitches at the beginning and end of each character.

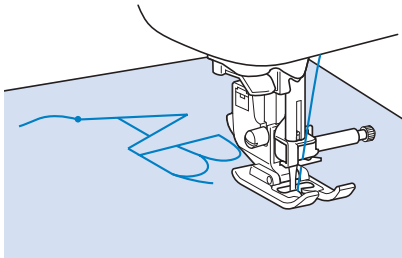

- When sewing is completed, trim any excess thread between letters.

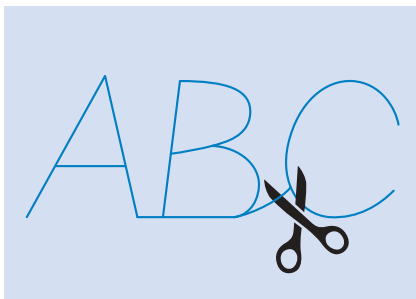

Note

- When sewing some patterns, the needle will temporarily pause in the raised position while the fabric is fed due to the operation of the needle bar separation mechanism which is used in this machine. At such times, a clicking sound different from the sound generated during sewing will be heard. This sound is normal and is not the sign of a malfunction.

Making adjustments

Your stitch pattern may sometimes turn out poorly, depending on the type or thickness of fabric, the stabilizer material used, sewing speed, etc. If your sewing does not turn out well, sew trial stitches using the same conditions as the real sewing, and adjust the stitch pattern as explained below. If the pattern does not turn out well even after making adjustments based on the pattern described below, make adjustments for each pattern individually.

- 1 Press  and select the following pattern on 14/14.

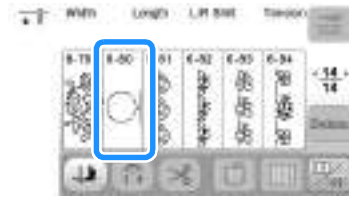

- 2 Attach monogramming foot "N" and sew the pattern.

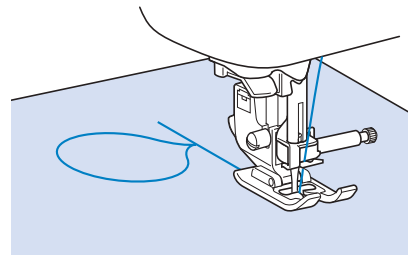

Note

- Be sure to use monogramming foot "N". Adjustments may not be made correctly with any other presser foot.

- 3 Compare the finished pattern to the illustration of the correct pattern below.

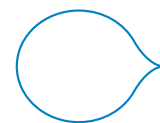

- 4 Press , and then adjust the pattern with the “Fine Adjust Verti.” or “Fine Adjust Horiz.” displays.



- If the pattern is bunched:
Press  in the “Fine Adjust Verti.” display.
→ The displayed value increases each time the button is pressed and the pattern will lengthen.

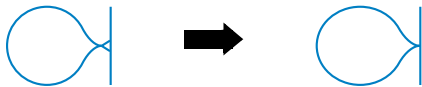

- If the pattern has gaps:
Press  in the “Fine Adjust Verti.” display.
→ The displayed value decreases each time the button is pressed and the pattern will shorten.

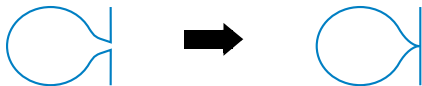

- If the pattern is skewed to the left:
Press  in the “Fine Adjust Horiz.” display.
→ The displayed value increases each time the button is pressed and the pattern will slide to the right.

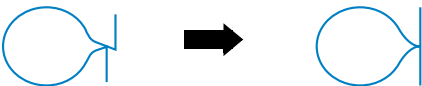

- If the pattern is skewed to the right:
Press  in the “Fine Adjust Horiz.” display.
→ The displayed value decreases each time the button is pressed and the pattern will slide to the left.



5 Sew the stitch pattern again.

- If the stitch pattern still comes out poorly, make adjustments again. Adjust until the stitch pattern comes out correctly.

 **Memo**

- You can sew with the setting screen on the display.

6 Press  to return to the original screen.

Editing Stitch Patterns

You can create just the finish you want using the editing functions. Make patterns larger or smaller, make mirror images, etc.



Note

- Some editing functions cannot be used with certain stitch patterns. Only the functions for the displayed keys are available when a pattern is selected.







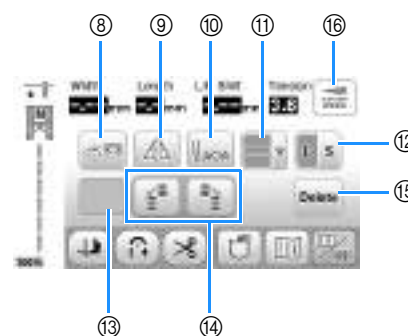
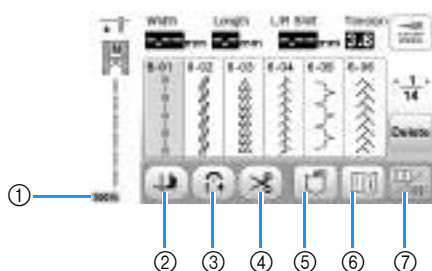

■ Character/decorative stitch screen

■ Character/decorative stitch editing screen





| No. | Display | Key Name | Explanation | Page |
|-----|---------|-------------------------------------|---|--------------|
| ① | 100% | Pattern display size | Show the approximate size of the pattern selected. 100%: Nearly the same size as the sewn pattern 50%: 1/2 the size of the sewn pattern 25%: 1/4 the size of the sewn pattern The actual size of the sewn pattern may differ depending on the type of fabric and thread that is used. | - |
| ② | | Pivot key | Press this key to select the pivot function. For details, refer to "Pivoting" in the "Basic operations" section. | - |
| ③ | | Automatic reverse/reinforcement key | Press this key to use the automatic reverse/reinforcement stitching function. For details, refer to "Automatic reinforcement stitching" in the "Basic operations" section. | - |
| ④ | | Automatic thread cutting key | Press this key to set the automatic thread cutting function. For details, refer to "Automatically cutting the thread" in the "Basic operations" section. | - |
| ⑤ | | Memory key | Use this key to save stitch pattern combinations. | D-15 to D-16 |
| ⑥ | | Image key | Press this key to display an enlarged image of the selected stitch pattern. | D-11 |
| ⑦ | | Edit/stitch switching key | Press this key to switch to the editing screen and character/decorative stitch screen. | - |
| ⑧ | | Free motion mode key | Press this key to enter free motion sewing mode. Presser foot is raised to a height appropriate for free motion quilting. For details, refer to "Sewing with free motion mode" in the "Basic operations" section. | - |
| ⑨ | | Horizontal mirror image key | After selecting the stitch pattern, use this key to create a horizontal mirror image of the stitch pattern. | D-9 |
| ⑩ | | Back to beginning key | When sewing is stopped, press this key to return to the beginning of the pattern. | D-10 |
| ⑪ | | Single/Repeat sewing key | Press this key to choose single stitches or continuous stitches. | D-9 |
| ⑫ | | Size selection key | Use this key to select the size of the stitch pattern (large, small). | D-9 |



| No. | Display | Key Name | Explanation | Page |
|-----|--|-----------------------|---|-------------|
| ⑬ | Some of the following keys will appear, depending on the selected stitch pattern. | | | |
| |  | Elongation key | When 7mm satin stitch patterns are selected, press this key to choose from 5 automatic length settings, without changing the stitch zigzag width or stitch length settings. | D-9 |
| |  | Thread density key | After selecting the stitch pattern, use this key to change the thread density of the pattern. | D-10 |
| |  | Character spacing key | Press this key to change the spacing of character patterns. | D-3 |
| ⑭ |   | Step stitch keys | Use these keys to make step stitch patterns. | D-3 |
| ⑮ |  | Delete key | When you make a mistake selecting a stitch pattern, use this key to delete the mistake. When you make a mistake in combining stitch patterns, use this key to delete stitch patterns. | D-2, D-3 |
| ⑯ |  | Manual adjustment key | Press this key to change the stitch length, stitch width, "L/R Shift" or thread tension. For details, refer to "Setting the Stitch" in the "Basic operations" section. | - |

Changing the size

After selecting desired stitch, press  and then press  to change the size of the stitch pattern. The stitch pattern will be sewn in the size highlighted on the key.



Memo

- If you continue entering stitch patterns after changing the size, those patterns will also be sewn in that size.
- You cannot change the size of combined stitch patterns once the stitch pattern is entered.

- Example:** Actual stitch pattern size
The size differs depending on the fabric and threads.
Large size



Small size



Changing the length (for 7 mm satin stitch patterns only)

When 7mm satin stitch patterns are selected, press  on the editing screen to choose from 5 automatic length settings, without changing the stitch zigzag width or stitch length settings.

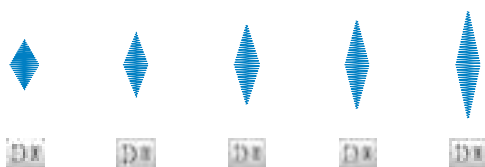

Creating a horizontal mirror image

To create a horizontal mirror image, select a stitch pattern then press  on the editing screen.



→ The stitch pattern is inverted.



Sewing a pattern continuously

Press  on the editing screen to select continuous sewing or single stitch sewing.



→ The stitch pattern turns continuous.



Memo

- To finish a complete motif while sewing the pattern continuously, you can press the  key while sewing. The machine will automatically stop when the motif is finished.

Changing thread density (for satin stitch patterns only)

After selecting a satin stitch pattern, press  on the editing screen to select your preferred thread density.





Low density ()

High density ()



CAUTION

- If the stitches bunch when thread density is changed to , return the thread density to . If you continue sewing when the stitches are bunched, the needle may bend or break.

Memo

- Even if you select a new pattern after changing the thread density, the thread density remains the same until you change it.
- You cannot change thread density for a combined pattern after additional patterns are added.

Returning to the beginning of the pattern

You can return to the beginning of the pattern after trial sewing or when the stitching is sewn incorrectly.

- 1 Press the “Start/Stop” button to stop the machine, and then press  on the editing screen.



→ Sewing returns to the beginning of the selected pattern (“W”) from the point where sewing was stopped.

Memo



- If this key is pressed when sewing is stopped, patterns can be added at the end of a combined stitch pattern. (In this example, “!” is added.)



- 2 Press the “Start/Stop” button to continue sewing.

Checking the image

You can display an approximate size image of the selected stitch pattern. You can also check and change the colors of the image on the screen.





- 1 Press .
 - An image of the selected pattern is displayed.
- 2 Press  to change the thread color in the image to red, blue, or black.



→ The color changes every time you press the button.

- 3 Press  to display the enlarged image.



- 4 Use  /  /  /  to view any part of the image that extends out of the viewable display area.

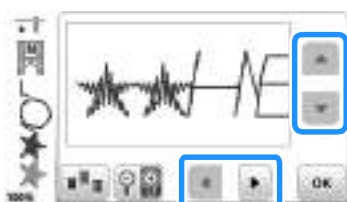

- 5 Press  to return to the original screen.



Memo

- You can also sew from this screen when the presser foot symbol is displayed.
- Image of some patterns will display in default size only.

Combining Stitch Patterns

You can combine many varieties of stitch patterns, such as character stitches, cross stitches, satin stitches, or stitches you design with MY CUSTOM STITCH function (page 19 for information about MY CUSTOM STITCH). You can also combine stitch patterns of different sizes, mirror image stitch patterns and others.

Before combining

Single stitch sewing is automatically selected for sewing combined patterns. If you want to sew the pattern continuously, press to change after selecting the stitch pattern combination.

When changing sizes, creating mirror images, or making other adjustments to a combined stitch pattern, be sure to edit the selected stitch pattern before selecting the next one. You cannot edit a stitch pattern once the next stitch pattern is selected.

Combining various stitch patterns

□ Example:



1 Press .



2 Select the following pattern on 7/14.

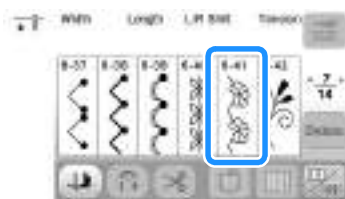

3 Press .

→ The display returns to the stitch selection screen.

4 Press .

5 Select the following pattern on 1/3.

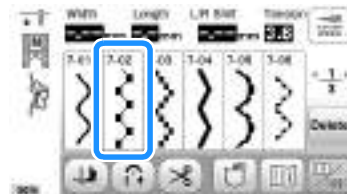

6 Press to display editing screen, and then press .

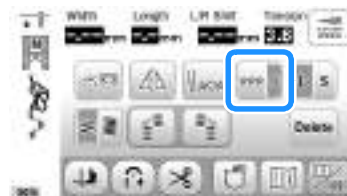

→ The entered pattern is repeated.



Memo

- Patterns are deleted individually starting with the last pattern entered by pressing .

Combining large and small stitch patterns

1 Press a desired pattern.

→ The large size stitch will be selected.

2 Press to display editing screen, and then press .

→ The stitch turns to a single pattern.

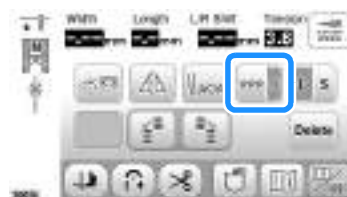

3 Press to display the previous screen, and select the same pattern again.

4 Press to display editing screen again, and then press .

→ The pattern is displayed in a smaller size.



5 Press .

→ The entered pattern is repeated.



Combining horizontal mirror image stitch patterns

1 Press a desired pattern.

2 Press to display editing screen, and then press .



→ The stitch turns to a single pattern.

3 Press to display the previous screen, and select the same pattern again.

4 Press to display editing screen again, and then press .



→ The pattern is flipped along a vertical axis.

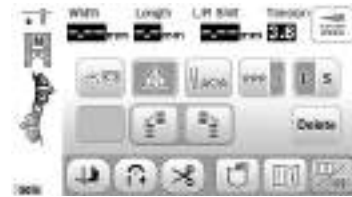

Note

• Some stitch patterns cannot be flipped. If a stitch pattern that cannot be flipped is selected, in the editing screen appears in light gray and is not available.

5 Press .

→ The entered pattern is repeated.

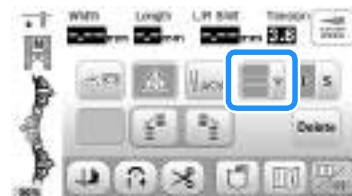

Combining stitch patterns of different length

□ Example:



1 Press .

2 Press the following pattern on 2/3.

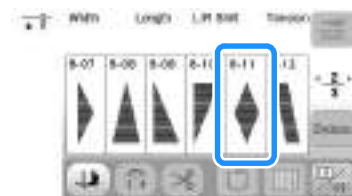

3 Press to display editing screen, and then press .

→ The stitch turns to a single pattern.

4 Press once.

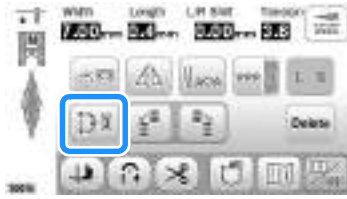

→ The length of the image is set to .

5 Press to display the previous screen, and select the same pattern again.

6 Press to display editing screen again, and then three times.

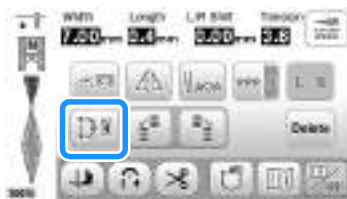

→ The length of the image is set to .

7 Press .

→ The entered pattern is repeated.

Making step stitch patterns

You can use the keys to create a step effect.

Stitch patterns sewn so that they create a step effect are called step stitch patterns.

Press these keys to shift the stitch pattern to the left or right by half width of the pattern.

□ Example:



1 Press .

2 Press the following pattern on 2/3.

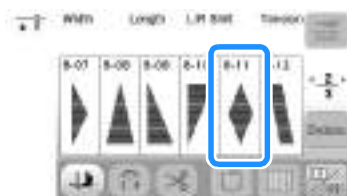

3 Press to display editing screen, and then press .

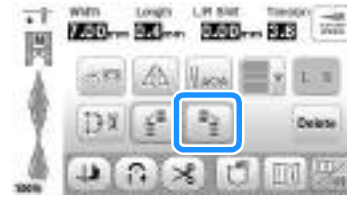

→ The next stitch pattern will move to the right.



4 Press to display the previous screen, and select the same pattern again.

5 Press to display editing screen again, and then press .

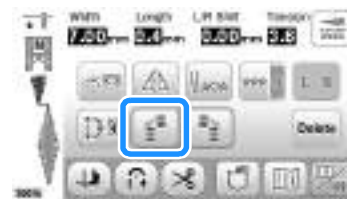

→ The next stitch pattern will move to the left.



6 Press .

→ The entered pattern is repeated.

More Examples

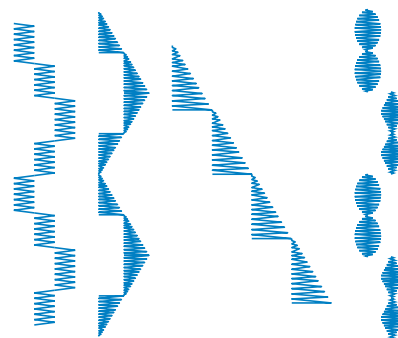

Using The Memory Function

Stitch data precautions

Observe the following precautions when using stitch data other than what was created and saved in this machine.

■ Types of stitch data that can be used

In the Character/Decorative Stitch memory, “.pmv”, “.pmx” and “.pmu” stitch data files can be used with this machine. “.pmu” or “.pmx” stitch data files can be retrieved; however, when the machine is used to save the file, it is saved as a “.pmv” stitch data file. Using data other than what was created using this machine or the machine which create “.pmv”, “.pmx” or “.pmu” data file, may cause the machine to malfunction.

■ Types of USB media that can be used

Stitch data can be saved to or recalled from a USB flash drive of any size.

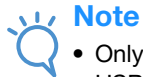

Note

- Only a USB flash drive can be connected to the USB port on this machine.
- Some USB flash drives may not be usable with this machine. Please visit our website for more details.
- The access lamp will begin blinking after inserting USB flash drive, and it will take about 5 to 6 seconds to recognize the Media. (Time will differ depending on the USB flash drive).
- For additional information, refer to the instruction manual included with the USB flash drive that you have purchased.

■ Precautions on using the computer to create and save data

- If the name of the stitch data file/folder cannot be identified, for example, because the name contains special characters, the file/folder is not displayed. If this occurs, change the name of the file/folder. We recommend using the 26 letters of the alphabet (uppercase and lowercase), the numbers 0 through 9, “-”, and “_”.
- Stitch data in a folder created in USB flash drive can be retrieved. To create file folders, use a computer.

Saving stitch patterns in the machine's memory

You can save often used stitch patterns in the machine's memory. Up to 15 stitch patterns (a total of about 128 KB) can be saved in the machine's memory.



Note

- Do not turn the main power to OFF while the “Saving...” screen is displayed. You will lose the stitch pattern you are saving.



Memo

- It takes a few seconds to save a stitch pattern.
- See page D-17 for information on retrieving a saved stitch pattern.

1 Press .

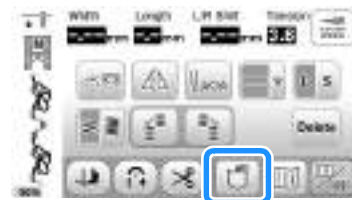

2 Press .



- Press  to return to the original screen without saving.
- The “Saving...” screen is displayed. When the pattern is saved, the display returns to the original screen automatically.

■ If the memory is full



If the following screen appears while you are trying to save a pattern on the machine's memory, the memory is too full to hold the currently selected stitch pattern. To save the stitch pattern in the machine's memory, you have to delete a previously saved stitch pattern.

1 Press .

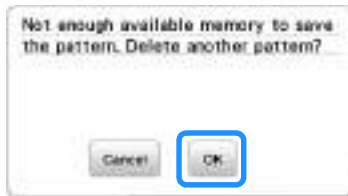
- Press  to return to the original screen without saving.



2 Choose a stitch pattern to delete.

- Press   to move to the previous/next page.
- Press  if you decide not to delete the stitch pattern.



3 Press .



→ A confirmation message appears.

4 Press .

- If you decide not to delete the stitch pattern, press .



→ The machine deletes the stitch pattern, then automatically saves the new stitch pattern.

Saving stitch patterns to USB flash drive

When sending stitch patterns from the machine to USB flash drive, plug the USB flash drive into the machine's USB port.

 **Memo**

- USB flash drive is commercially available, but some USB flash drives may not be usable with this machine. Please visit our website "<http://support.brother.com/>" for more details.
- The USB flash drive can be inserted or removed at any time except when saving or deleting.

1 Press .



2 Insert the USB flash drive into the USB port on the machine.

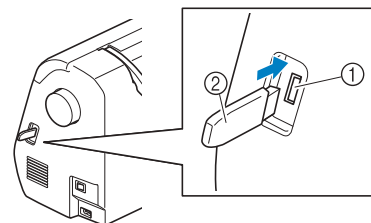

- ① USB port
- ② USB flash drive

 **Note**

- The processing speed may vary by quantity of data.

3 Press .



- Press  to return to the original screen without saving.

→ The "Saving..." screen is displayed. When the pattern is saved, the display returns to the original screen automatically.

→ The pattern is saved in a folder labeled "bPocket".

 **Note**

- Do not insert or remove USB flash drive while "Saving..." screen is displayed. You will lose some or all of the pattern you are saving.

Retrieving stitch patterns from the machine's memory

- 1 Press .



→ The pocket selection screen will then appear.

- 2 Choose a stitch pattern to retrieve.

- If the entire saved stitch pattern is not displayed, press the thumbnail.



- Press  to return to the original screen without selecting a pattern.

- 3 Press .

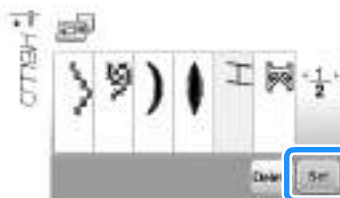

→ The selected stitch pattern is retrieved and the sewing screen will be displayed.

- Press  to delete the stitch pattern.



Note

- When you press , the selected pattern will be deleted permanently from the machine's memory.

Recalling from USB flash drive

You can recall a specific stitch pattern from USB flash drive. If the stitch pattern is in a folder, check each folder to find the stitch pattern.

- 1 Insert the USB flash drive into the USB port on the machine.

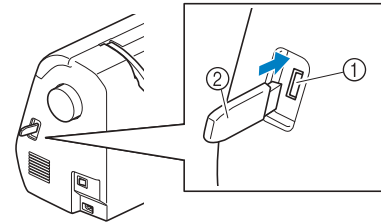

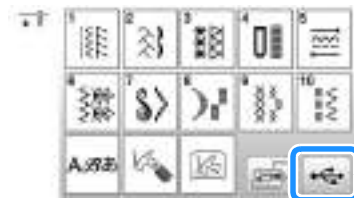

- ① USB port
② USB flash drive

- 2 Press .



- 3 Select the pattern. If the stitch pattern to be retrieved is in a folder, press the key for that folder.

- Press   to move to the previous/next page.
- Press  to return to the original screen without recalling.

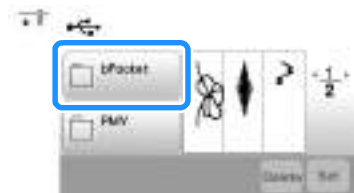

→ Stitch patterns within a folder are displayed.



- ① Folder name
② Stitch patterns in a folder show only the first pattern of any combined patterns.

- Press  to return to the previous screen.
- Use the computer to create folders. Folders cannot be created with the machine.

- 4 Press the key of the stitch pattern you want to recall.

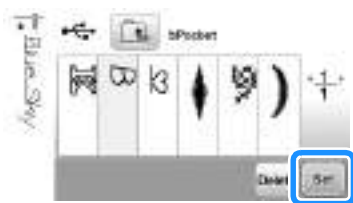

5 Press .

- Press  to delete the stitch pattern. The pattern will be deleted from the USB flash drive.



→ The selected stitch pattern is recalled and the sewing screen will be displayed.

 **Note**

- You can recall and sew the MY CUSTOM STITCH pattern saved in the USB flash drive by pressing , but it cannot be edited here. If you want to edit the MY CUSTOM STITCH pattern, press  first, and then press  to recall it.

Chapter 2 MY CUSTOM STITCH

D
MY CUSTOM STITCH

Designing a Stitch

By using the MY CUSTOM STITCH function, you can register stitches you have created yourself. You can also sew designs combining MY CUSTOM STITCH creations with built-in characters (page D-2).

Memo

- Stitches that you create with MY CUSTOM STITCH can be a maximum of 7 mm (approx. 9/32 inch) wide and 37 mm (approx. 1-1/3 inches) long.
- Stitches can be designed more easily with MY CUSTOM STITCH if you first draw the stitch on the included grid sheet.

1 Draw the stitch design on the grid sheet.

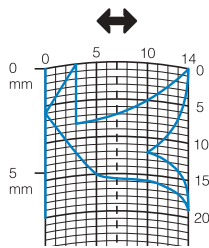

Memo

- Simplify the design so that it can be sewn as a continuous line. For a more attractive stitch, close the design by intersecting lines.

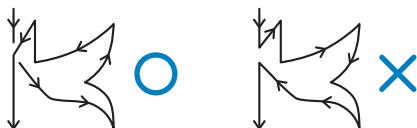

If the design is to be repeated and linked, the start point and end point of the design should be at the same height.



2 Decide the spacing of the stitch.

- By adjusting the spacing of a stitch, you can create various patterns with one stitch.

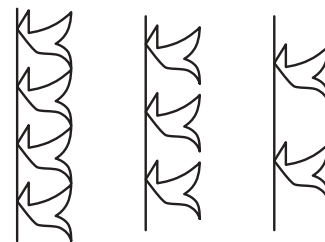
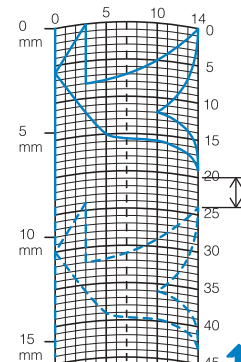

3 Place points where the pattern intersects with the grid, and connect all the points with a line.

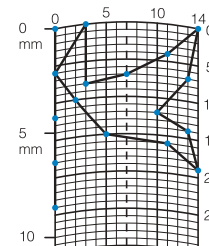

4 Determine the x and y coordinates of each of the marked points.

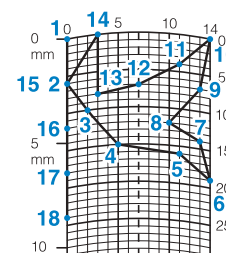



Memo

- This will determine the stitch design that will be sewn.

□ Examples of Custom Stitches

| | | | | | | | | | | | | | | | | |
|---|---------------|-----------|-----------|-----------|-----------|-----------|-----------|-----------|-----------|-----------|-----------|-----------|-----------|-----------|-----------|-----------|
|  | Stitch | 1 | 2 | 3 | 4 | 5 | 6 | 7 | 8 | 9 | 10 | 11 | 12 | 13 | 14 | 15 |
| | ↕ | 0 | 12 | 18 | 22 | 23 | 21 | 17 | 14 | 12 | 9 | 6 | 3 | 1 | 3 | 6 |
| | ↔ | 0 | 0 | 3 | 6 | 10 | 13 | 14 | 13 | 11 | 13 | 14 | 13 | 10 | 6 | 3 |
| | Stitch | 16 | 17 | 18 | 19 | 20 | 21 | 22 | 23 | 24 | 25 | 26 | 27 | 28 | 29 | 30 |
| | ↕ | 12 | 41 | 43 | 40 | 41 | 38 | 35 | 32 | 30 | 32 | 35 | 41 | 45 | 47 | 44 |
| | ↔ | 0 | 0 | 4 | 7 | 11 | 13 | 14 | 13 | 10 | 6 | 3 | 0 | 0 | 4 | 7 |
| | Stitch | 31 | 32 | 33 | 34 | 35 | 36 | 37 | 38 | 39 | 40 | 41 | 42 | 43 | 44 | 45 |
| | ↕ | 45 | 47 | 50 | 54 | 56 | 55 | 51 | 45 | 70 | | | | | | |
| ↔ | 11 | 13 | 14 | 13 | 10 | 6 | 3 | 0 | 0 | | | | | | | |

| | | | | | | | | | | | | | | | | |
|---|---------------|-----------|-----------|-----------|-----------|-----------|-----------|-----------|-----------|-----------|-----------|-----------|-----------|-----------|-----------|-----------|
|  | Stitch | 1 | 2 | 3 | 4 | 5 | 6 | 7 | 8 | 9 | 10 | 11 | 12 | 13 | 14 | 15 |
| | ↕ | 0 | 30 | 32 | 32 | 32 | 33 | 35 | 35 | 37 | 35 | 32 | 30 | 30 | 29 | 26 |
| | ↔ | 0 | 0 | 1 | 7 | 10 | 12 | 11 | 8 | 12 | 14 | 14 | 11 | 5 | 3 | 8 |
| | Stitch | 16 | 17 | 18 | 19 | 20 | 21 | 22 | 23 | 24 | 25 | 26 | 27 | 28 | 29 | 30 |
| | ↕ | 24 | 18 | 13 | 12 | 13 | 10 | 12 | 8 | 12 | 7 | 12 | 6 | 10 | 5 | 10 |
| | ↔ | 10 | 13 | 14 | 14 | 12 | 11 | 10 | 9 | 8 | 6 | 6 | 3 | 2 | 0 | 2 |
| | Stitch | 31 | 32 | 33 | 34 | 35 | 36 | 37 | 38 | 39 | 40 | 41 | 42 | 43 | 44 | 45 |
| | ↕ | 16 | 19 | 23 | 22 | 17 | 22 | 23 | 19 | 42 | | | | | | |
| ↔ | 1 | 0 | 0 | 6 | 10 | 6 | 0 | 0 | 0 | | | | | | | |



| | | | | | | | | | | | | | | | | |
|---|---------------|-----------|-----------|-----------|-----------|-----------|-----------|-----------|-----------|-----------|-----------|-----------|-----------|-----------|-----------|-----------|
|  | Stitch | 1 | 2 | 3 | 4 | 5 | 6 | 7 | 8 | 9 | 10 | 11 | 12 | 13 | 14 | 15 |
| | ↕ | 0 | 3 | 5 | 8 | 12 | 17 | 20 | 24 | 27 | 29 | 31 | 32 | 30 | 27 | 24 |
| | ↔ | 0 | 5 | 8 | 11 | 13 | 14 | 14 | 13 | 12 | 11 | 9 | 6 | 3 | 1 | 0 |
| | Stitch | 16 | 17 | 18 | 19 | 20 | 21 | 22 | 23 | 24 | 25 | 26 | 27 | 28 | 29 | 30 |
| | ↕ | 21 | 18 | 16 | 15 | 15 | 16 | 18 | 21 | 25 | 28 | 33 | 37 | 41 | 43 | 44 |
| | ↔ | 0 | 1 | 3 | 5 | 8 | 10 | 12 | 13 | 14 | 14 | 13 | 11 | 8 | 5 | 0 |
| | Stitch | 31 | 32 | 33 | 34 | 35 | 36 | 37 | 38 | 39 | 40 | 41 | 42 | 43 | 44 | 45 |
| | ↕ | | | | | | | | | | | | | | | |
| ↔ | | | | | | | | | | | | | | | | |





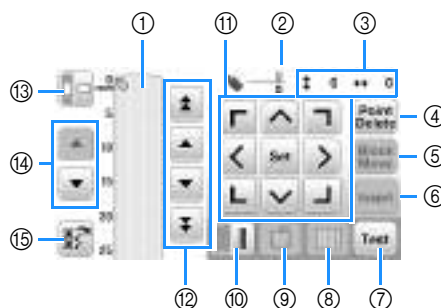









| | | | | | | | | | | | | | | | | |
|---|---------------|-----------|-----------|-----------|-----------|-----------|-----------|-----------|-----------|-----------|-----------|-----------|-----------|-----------|-----------|-----------|
|  | Stitch | 1 | 2 | 3 | 4 | 5 | 6 | 7 | 8 | 9 | 10 | 11 | 12 | 13 | 14 | 15 |
| | ↕ | 0 | 5 | 4 | 5 | 8 | 7 | 8 | 11 | 11 | 11 | 16 | 11 | 7 | 4 | 0 |
| | ↔ | 7 | 7 | 3 | 7 | 7 | 0 | 7 | 7 | 3 | 7 | 7 | 3 | 0 | 3 | 7 |
| | Stitch | 16 | 17 | 18 | 19 | 20 | 21 | 22 | 23 | 24 | 25 | 26 | 27 | 28 | 29 | 30 |
| | ↕ | 4 | 7 | 11 | 16 | 21 | 20 | 21 | 24 | 23 | 24 | 27 | 27 | 27 | 32 | 27 |
| | ↔ | 11 | 14 | 11 | 7 | 7 | 11 | 7 | 7 | 14 | 7 | 7 | 11 | 7 | 7 | 11 |
| | Stitch | 31 | 32 | 33 | 34 | 35 | 36 | 37 | 38 | 39 | 40 | 41 | 42 | 43 | 44 | 45 |
| | ↕ | 23 | 20 | 16 | 20 | 23 | 27 | 32 | | | | | | | | |
| ↔ | 14 | 11 | 7 | 3 | 0 | 3 | 7 | | | | | | | | | |

Entering Stitch Data

MY CUSTOM STITCH screen





- ① This area displays the stitch being created.
- ② Displays the number of the present set point over the total number of points in the stitch.
- ③ Displays the y-coordinate of  over the x-coordinate of .

| No. | Display | Key Name | Explanation | Page |
|-----|---|-----------------------------|--|-----------------|
| ④ |  | Point delete key | Press this key to delete a selected point. | D-22 |
| ⑤ |  | Block move key | Press this key to group points together and move them together. | D-23 |
| ⑥ |  | Insert key | Press this key to insert new points on the stitch design. | D-23 |
| ⑦ |  | Test key | Press this key to sew a test of the stitch. | D-22, D-24 |
| ⑧ |  | Image key | Press this key to view an image of the stitch. | D-22 |
| ⑨ |  | MY CUSTOM STITCH memory key | Press this key to store the stitch being created. | D-24 |
| ⑩ |  | Single/triple stitching key | Press this key to select whether one or three stitches will be sewn between two points. | D-22 |
| ⑪ |  | Arrow keys and set key | Use these keys to move  over the display area, and press the set key in the center to set a point on the stitch design. | D-22 to D-23 |
| ⑫ |  | Point-to-point key | Use these keys to move  from point to point on the stitch, or to the first or last point entered on the stitch. | D-22 to D-23 |
| ⑬ |  | Grid direction key | Press this key to change the direction of the grid sheet. | D-22 |
| ⑭ |  | Page scroll key | Press this key to scroll the grid sheet. | - |
| ⑮ |  | Sample pattern retrieve key | Press this key to display built-in sample patterns that can be edited. | D-23 |



1 Press .





2 Use  to move  to the coordinates of the first point on the grid sheet.

- Press  to change the direction of the grid sheet.







- ① Currently selected point/Total number of points
- ② Coordinates of 

3 Press  to add the point indicated by .





4 Select whether one stitch or three stitches will be sewn between the first two points.

- To sew three stitches, press the key so that it appears as .

5 Use  to move  to the second point and press .



6 Repeat the steps above for each point that you have drawn on the grid sheet until the stitch design is drawn on the screen as a continuous line.

- Pressing each key to perform the following operation.
 - : Delete a selected point entered.
 - : Sew a test-run of the stitch.
 - : View an image of the stitch.

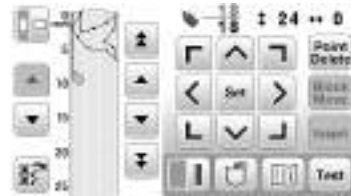

- Press  to return to the original screen.



Memo

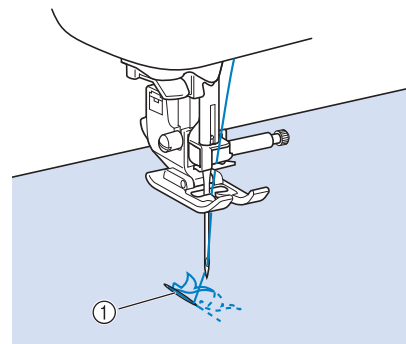



- If you have entered points that are too close together, the fabric may not feed properly. Edit the stitch data to leave a larger space between points.
- If the stitch design is to be repeated and linked, make sure that linking stitches are added so that the stitch designs will not overlap.



① Linking stitches

Moving a point

1 Press  or  to move  to the point that you want to move.

- To move  to the first point, press .
- To move  to the last point, press .

2 Use  to move the point.



■ Moving part or all of the design

1 Press or to move to the first point of the section that you want to move.

- To move to the first point, press .
- To move to the last point, press .

2 Press .

→ The selected point and all points that were entered after it are selected.

3 Press or to move the section.



4 Press .

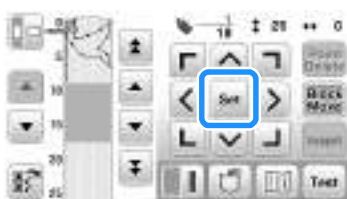

→ The section will be moved.



■ Inserting new points

1 Press or to move to a place on the design where you want to add a new point.

- To move to the first point, press .
- To move to the last point, press .

2 Press .



→ A new point is entered and moves to it.

3 Use to move the point.



Editing a built-in sample pattern

Sample patterns can be retrieved and edited in MY CUSTOM STITCH.

1 Press .

→ The built-in sample patterns that can be edited are displayed.

- Sample patterns are divided into categories. Press a tab at the top of the screen to display the desired pattern.



① Tab

2 Select a pattern, and then press .

→ The selected pattern appears in the page.

3 Edit the pattern.

- For details on editing the stitch pattern, refer to “Entering Stitch Data” on page D-21.



Note

- For details on saving the edited pattern, refer to “Storing custom stitches in your list” on page D-24.



Memo

- Sample patterns can be combined and edited.

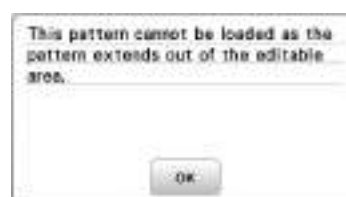

■ If the error message is displayed

This following message appears when the sample pattern that you try to add with the MY CUSTOM STITCH function extends out of the stitching area. Select a different pattern, or delete the existing pattern (point).



Using Stored Custom Stitches

Storing custom stitches in your list

Stitch patterns created using the MY CUSTOM STITCH function can be stored for later use. Once you finish entering the stitch data, press  and then press either  or . When you save the pattern to USB flash drive, it is saved in a folder labeled “bPocket”. The “Saving...” message appears and the stitch will be stored.

Before storing a stitch, press  to sew a test-run of the stitch.



Memo

- Storing a stitch pattern takes a few seconds.
- For details on retrieving a stored stitch pattern, see page D-24.

Note



- Do not turn off the machine while the “Saving...” message is displayed, otherwise the stitch pattern data being saved may be lost.

■ If the memory is full

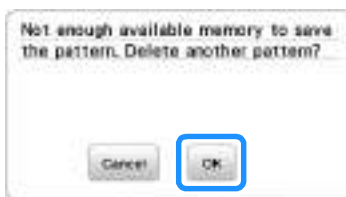

If the following message appears after  is pressed, the stitch pattern cannot be stored because either the machine’s memory is full or the stitch pattern being stored is larger than the amount of space available in the memory. To be able to store the stitch pattern in the machine’s memory, a previously stored stitch pattern must be deleted.



Retrieving stored stitches



- 1 Press .
- 2 Press  or  to select the location of the pattern to be retrieved.

- 3 Select the stitch pattern.

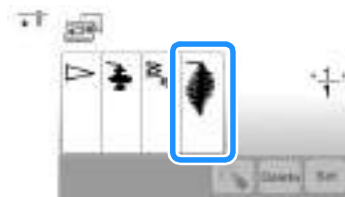
- Press  or  to move to the previous/next page.
- Press  to return to the previous screen without retrieving.



- 4 Press .

- To delete the stored stitch pattern, press .
- To edit the stored stitch pattern, press .

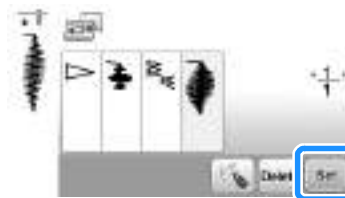

Note

- When a retrieved pattern is saved after it has been edited, the edited pattern is saved as a different file.



Embroidering

This section provides instruction to embroider designs with this machine.
Page number starts with “E” in this section.

The screen display and machine illustration may vary slightly, depending on the countries or regions.

Chapter1 EMBROIDERY E-2

Chapter 1 EMBROIDERY

Selecting Patterns

Prepare the machine for embroidery according to the instructions on “STARTING TO EMBROIDER” of “Basic operations”.

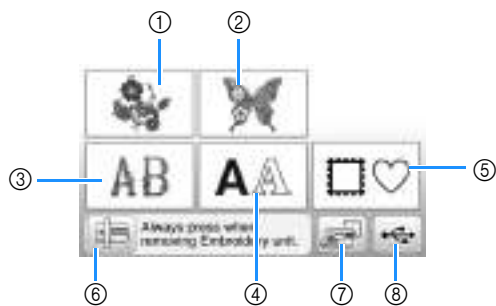

- ① Embroidery patterns
- ② Brother “Exclusives”
- ③ Floral alphabet patterns
- ④ Character patterns
- ⑤ Frame patterns
- ⑥ Press this key to position the embroidery unit for storage.
- ⑦ Patterns saved in the machine’s memory (page E-32)
- ⑧ Patterns saved in USB flash drive (page E-33)

Memo

- See included “Embroidery Design Guide” for more information on each category’s selection screen.

Selecting embroidery patterns/Brother “Exclusives”/floral alphabet patterns

- 1 Select the category of the pattern.



- 2 Press the key of the desired pattern.



→ The pattern is displayed in the left part of the screen.

- 3 Press .

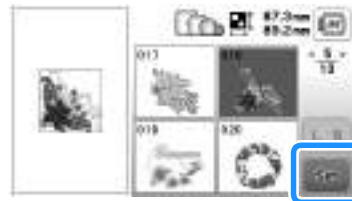

→ The pattern selected is outlined in red.

- 4 Proceed to “Editing Patterns” on page E-5 to edit the pattern.

Selecting character patterns

- **Example:** Entering “We Fly”.

- 1 Press .

- 2 Press the key of the font you want to embroider.

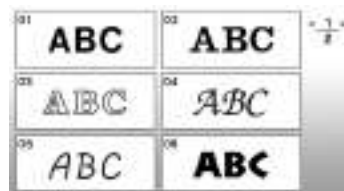

- 3 Press  to display “W” on the screen, and then enter “W”.

- The number located on the left side of the text input box at the top of the screen indicates the current line number.

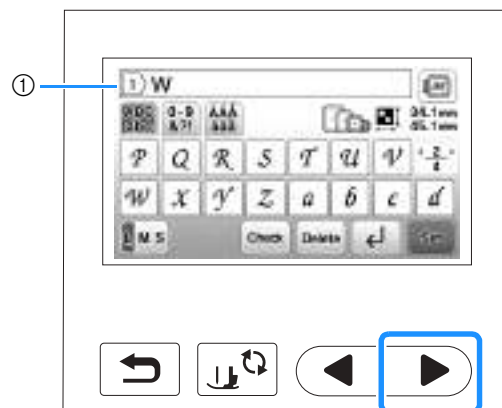

- ① Current line number

- 4 Press **▶** to display “e” on the screen, and then enter “e”.



- After selecting a character if you would like to change the character size press **↕**. The size changes each time you press the key, from large to medium to small.
- If you make a mistake, press **⌫** to erase the mistake.
- If the pattern is too small to see clearly, you can use the **Check** key to check it.
- If you want to add multiple lines, refer to “Entering a line feed” on page E-4.

Memo

- If you continue adding characters after changing the size, the new characters will be entered in the new size.

- 5 Press **▶**, and then press **␣** to enter a space.

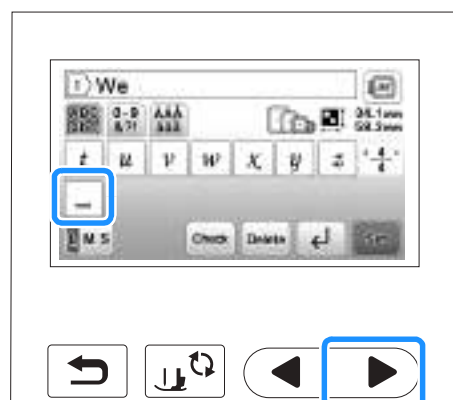

- 6 Press **▶**, and then enter “F”.



- 7 Press **▶** to display “l” and “y”, and enter them.

- 8 Press **↕**.



→ The editing screen is displayed.

- 9 Proceed to “Editing Patterns” on page E-5 to edit the pattern.

- For details on editing characters, refer to “Editing Character Patterns” on page E-9.
- To return to the previous screen to select another pattern, press **↶**.

■ Entering a line feed

Using the line feed key, multiple lines of text can be entered. Each line becomes a group, each of which can be edited one at a time.

- **Example:** Entering “High” in the second line of the following screen



- 1 Press .

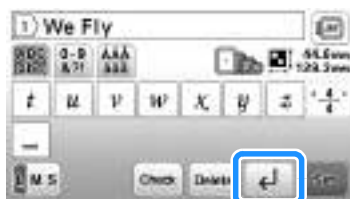

- 2 Enter “High”.







- 3 Press .

→ The editing screen is displayed.



Memo

- To change the text before the line feed in the text input screen, press , also to delete any text after the line feed.
- When  is pressed to change the character size, the size of characters in the displayed line of text is changed. To change the size of characters in a different line of text, press  to erase text until the line to be changed appears, or resize the pattern in the pattern editing screen.
- We recommend pressing  before entering a line feed in order to preview the pattern.



Selecting frame patterns

- 1 Press .

- 2 Press the key of the frame shape you want to embroidery.

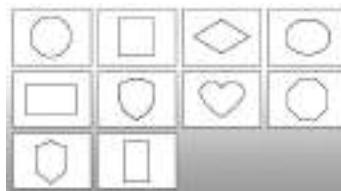

- 3 Press the key of the frame pattern you want to embroidery.

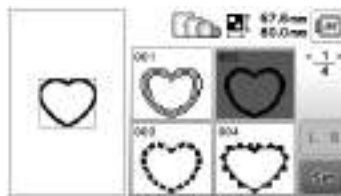

- If you make a mistake selecting the pattern, press the key of the pattern you want to embroider.

→ The selected pattern is displayed on the screen.



- 4 Press .

→ The editing screen is displayed.

- 5 Proceed to “Editing Patterns” on page E-5 to edit the pattern.

- To return to the previous screen to select another pattern, press .

Editing Patterns

When a pattern is selected in the pattern selection screen and  is pressed, the pattern editing screen appears. To finish editing, press  to continue to the embroidery settings screen.

■ Pattern editing screen

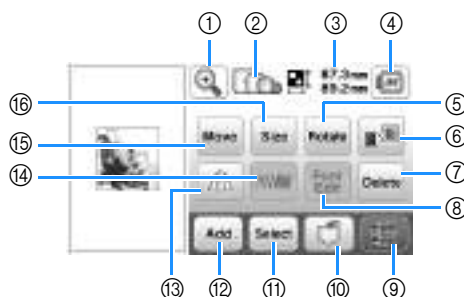

















Memo



- If a key display is light gray, you cannot use that function with the selected pattern.

CAUTION

- When you have revised the pattern, check the display of available embroidery frames and use an appropriate frame. If you use an embroidery frame not displayed as available for use, the presser foot may strike the frame and possibly cause injury.

| No. | Display | Key Name | Explanation | Page |
|-----|---|-----------------------------|---|------|
| ① |  | Magnify key | Press this key to magnify the pattern in the screen. | E-8 |
| ② |  | Embroidery frame | Shows the embroidery frames that can be used. | - |
| ③ |  | Pattern size | Shows the size of the entire combined pattern. | - |
| ④ |  | Preview key | Press this key to show sewn image. For details, refer to “Previewing the selected pattern” in the “Basic operations” section. | - |
| ⑤ |  | Rotate key | Press this key to rotate the pattern. You can rotate a pattern one degree, ten degrees or ninety degrees at a time. | E-6 |
| ⑥ |  | Thread palette key | Press this key to change the colors of the displayed pattern. | E-7 |
| ⑦ |  | Delete key | Press this key to delete the selected pattern (the pattern outlined by the red box). | E-7 |
| ⑧ |  | Font edit key | Press this key to display the font editing screen. For details, refer to “Editing All Patterns”. | E-9 |
| ⑨ |  | Edit End key | Press this key to call up the frame layout screen. For details, refer to “Editing Character Patterns”. | E-15 |
| ⑩ |  | Memory key | Press this key to save patterns to the machine's memory or USB flash drive. | E-31 |
| ⑪ |  | Pattern select key | When a combined pattern is selected, use these keys to select a part of the pattern to edit. | E-14 |
| ⑫ |  | Add key | Press this key to add another embroidery pattern to currently displayed pattern. | E-13 |
| ⑬ |  | Horizontal mirror image key | Press this key to make a horizontal mirror image of the selected pattern. | E-7 |
| ⑭ |  | Thread density key | Press this key to change thread density for some alphabet character and frame patterns. | E-7 |
| ⑮ |  | Move key | Press these keys to move the pattern. | E-6 |
| ⑯ |  | Size key | Press this key to change the size of the pattern. Patterns can be enlarged or reduced. | E-6 |

Moving the pattern

- 1 Press .
- 2 Use  to move the pattern in the direction shown by the arrow.
 - Press  to center the pattern.











① Distance from the center

Memo

- The pattern can also be moved by dragging it.
- Patterns cannot be moved in screens where  does not appear.

- 3 Press  to return to the original screen.

Changing the size of the pattern

- 1 Press .
- 2 Select the direction in which to change the size.
 - Pressing each key to change shape of the pattern as follows.
 - : Enlarge the pattern proportionately.
 - : Shrink the pattern proportionately.
 - : Stretch the pattern horizontally.
 - : Compact the pattern horizontally.
 - : Stretch the pattern vertically.
 - : Compact the pattern vertically.
 - : Return the pattern to its original size.



① Size of the pattern

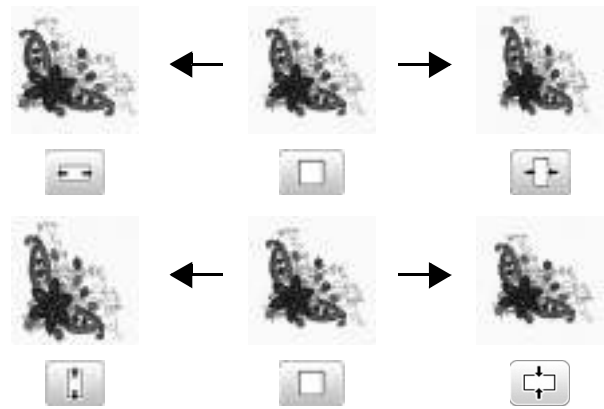









Memo

- Some patterns or characters can be enlarged more than others.
- Some patterns or characters can be enlarged to a greater degree if they are rotated 90 degrees.

- 3 Press  to return to the original screen.

Rotating the pattern

- 1 Press .
- 2 Select the angle of rotation for the pattern.
 - Pressing each key to rotate the pattern as follows.
 - : Rotate the pattern 90 degrees to the left.
 - : Rotate the pattern 90 degrees to the right.
 - : Rotate the pattern 10 degrees to the left.
 - : Rotate the pattern 10 degrees to the right.
 - : Rotate the pattern 1 degree to the left.
 - : Rotate the pattern 1 degree to the right.
 - Press  to return the pattern to its original position.



① Degree of rotation





- 3 Press  to return to the original screen.

Changing the thread color





You can change the thread color by choosing a new color from the thread colors in the machine.



1 In the pattern editing screen, press .

→ The thread color palette screen displays.

2 Press  or  to select the color you want to change.



3 Press , , , or  or touch the color on the color palette to choose a new color.

- To return to the original color, press , then press  after message appears. If multiple colors have been changed, this command will return all colors to their original colors.





① Color palette

→ The display shows the changed colors.

4 Press .

Creating a horizontal mirror image

Press  so it appears as  to create a horizontal mirror image of the selected pattern. Press  again to return the pattern to normal.





Changing the density (alphabet character and frame patterns only)

The thread density for some alphabet character and frame patterns can be changed.

A setting between 80% and 120% in 5% increments can be specified.

1 Press .

2 Change the density.

- Press  to make the pattern less dense.
- Press  to make the pattern more dense.

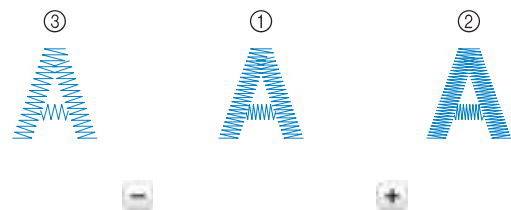
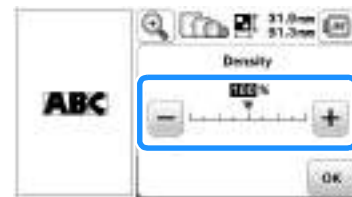

① Normal

② Fine (stitches closer together)

③ Coarse (stitches farther apart)

→ The pattern density changes each time you press a button.

3 Press .

Deleting the pattern

Press  to delete the pattern from the screen.



Displaying patterns in the screen magnification

1 Press .



→ Magnification select screen is displayed.

2 Press desired magnification to enlarge the pattern.



- Press  to return to the normal size.

3 Press  to return to the original screen.



After editing

1 Press .



- To combine the pattern with other patterns, select  (page E-13).
- For more information about sewing patterns, refer to “Embroidering a pattern” in the “Basic operations” section.

Memo







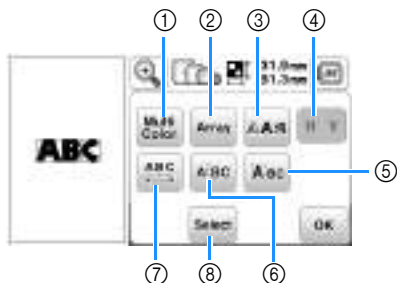

- If you want to return to the editing screen after pressing , press .

Editing Character Patterns

Font editing screen appears by pressing  on the pattern editing screen.



Font editing screen



| No. | Display | Key Name | Explanation | Page |
|-----|---|------------------------------|--|------|
| ① |  | Multi color key | Press this key to change the color of individual characters in a pattern. | E-9 |
| ② |  | Array key | Press this key to change the configuration of a character pattern. | E-12 |
| ③ |  | Font key | Press this key to change the font of the selected characters. | E-10 |
| ④ |  | Vertical/horizontal text key | Press this key to switch between text written vertically and horizontally. | E-9 |
| ⑤ |  | Edit character key | Press this key to edit each character separately. | E-11 |
| ⑥ |  | Split text key | Press this key to split text between characters so that they can be edited separately. | E-10 |
| ⑦ |  | Character spacing key | Press this key to change the spacing of character patterns. | E-10 |
| ⑧ |  | Select key | Press this key to select a character. If the line feed key was used while entering text, single lines can be selected. | - |

Changing the colors of alphabet character patterns

Combined alphabet character patterns can be sewn with each letter in a different color. If “MULTI COLOR” is set, the machine stops after each character is sewn so that the thread can be changed to a different color.

- 1 Press  so that it appears as .
 - Press the key again to return to the original setting.



- 2 Press  to return to the pattern editing screen.

- Press  to change the colors in the sewing order (see page E-7).

- 3 After a character is sewn, change the thread color, and then sew the next character.

Switching between text written vertically and horizontally

When the Japanese font is selected, the text can be switched between being written vertically and horizontally.

- 1 Press  to switch between text written vertically and horizontally.



- 2 Press  to return to the pattern editing screen.



Note

- Western characters cannot be written vertically.

Changing the font of entered characters

After text has been entered, the font can be changed.

- 1 Press **ABC**.
- 2 Select the font that you wish to use.

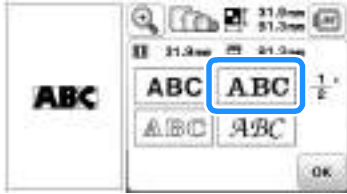

→ The text appears in the screen with the new font applied.

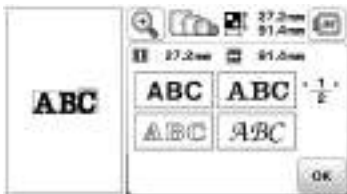

Note

- Depending on the font that was selected, it may not be possible to change the font.

Changing character spacing

- 1 Press **ABC**.
- 2 Press **+ABC-**/**-ABC+** to increase or decrease the character spacing.
 - Press **ABC** to return the pattern to its original appearance.



- 3 Press **OK** to return to the font editing screen.

Reducing character spacing

The spacing between characters can be reduced to 50% of the narrowest character in the group.



Note

- It is not recommended to edit data and transfer to other or older version machines. Same features do not apply in other machines, so problems may occur.
- Character spacing can be reduced only when characters are arranged normally on a straight line.



Separating combined character patterns

Combined character patterns can be separated to adjust the character spacing or to separately edit the patterns after all characters have been entered.

- 1 Press **ABC**.
- 2 Use **←**/**→** to select where the pattern is to be separated, and then press **✂** to separate it. For this example, the pattern will be separated between "A" and "B".



Note

- A separated character pattern cannot be combined again.

3 Press **OK** to return to the font editing screen.



Editing single characters

Press **Am** so that a single character can be selected for editing. The character size and font can be changed.

Changing the size

1 Press **Am**.

2 Select the character to be resized.

- To select the character, press **←** or **→**.
- The selected character is surrounded with a red box.



3 Select the direction in which to change the size.

- For details on the various keys, refer to the procedure in "Changing the size of the pattern" on page E-6.



4 Press **OK** to return to the font editing screen.



Changing the font

1 Press **Am**.

2 Press **Am**, and then select the character whose font is to be changed.

- To select the character, press **←** or **→**.
- The selected character is surrounded with a red box.

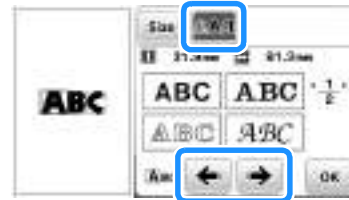

3 Select the font that you wish to use.

- The character changes to the selected font.

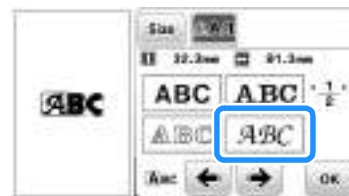

4 Press **OK** to return to the font editing screen.







Changing the configuration of character patterns





1 Press .

2 Press the key of the layout you want to embroider.



- When selecting an arc, use  and  to change the degree of the arc.
: Make the arc flatter.
: Make the arc rounder.

Memo

- When selecting ,  and  change to  and . You can increase or decrease the incline.

→ The display will show the selected layout.

□ Example:

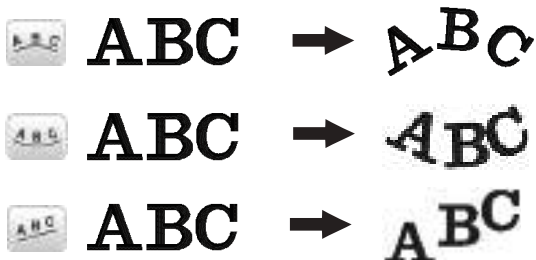

3 Press  to return to the font editing screen.



Combining Patterns

Editing combined patterns

- **Example:** Combining alphabet characters with an embroidery pattern and editing



1 Press to select an embroidery pattern.

2 Select the following pattern and then press .

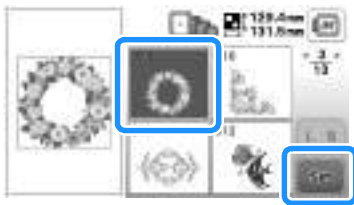

3 Press .



4 Press to enter the alphabet characters.

- Press to return to the previous screen.

5 Select and enter "Spring".

→ The characters you enter will be displayed in the upper part of the screen.

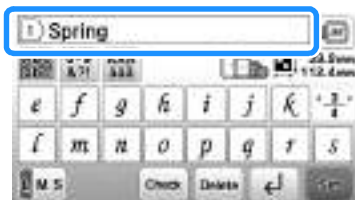

6 Press .

7 Press .



8 Press to move the characters.

- With your finger, drag the characters to move them.



9 Press to return to the pattern editing screen.

10 Press and to change the layout of the characters. Press two times to return to the pattern editing screen.

- See page E-12 for more information about changing the layout.

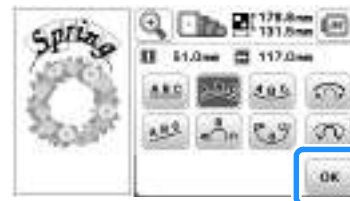

11 Press to change the color of the characters.

→ The thread color palette screen displays.

- See page E-7 for more information about changing the color.

12 Press to return to the pattern editing screen.

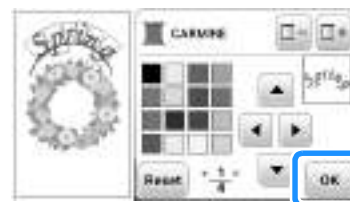

13 When all editing is finished, press **END** and then **START**.

→ Embroidering screen appears.



2 Embroider characters.



■ Selecting combined embroidery patterns

If multiple patterns have been combined, use **Touch** to select the pattern to be edited. In addition, patterns can be selected by directly touching the screen with your finger.



Memo

- Use **Touch** to select patterns that are overlapping and cannot be selected by touching the screen.

Embroidering combined patterns

Combined patterns will be embroidered in the order they were entered. In this example, the embroidery order will be as follows:

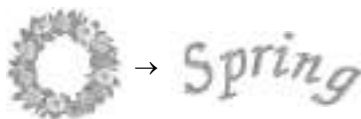



- For more information about sewing patterns, refer to “Embroidering a pattern” in the “Basic operations” section.

1 Embroider the flower pattern by following the color order on the display.







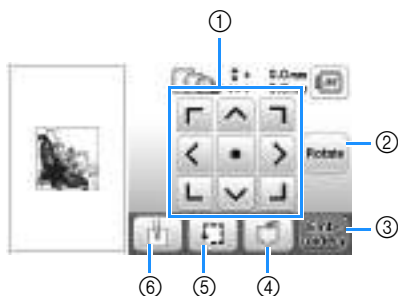

→ After the flowers are embroidered, the [+] cursor will move to the character part of the pattern.

Editing All Patterns

When  is pressed in the editing screen, the embroidery settings screen appears. After editing the pattern, press  to continue to the embroidering screen.

Embroidery settings screen



| No. | Display | Key Name | Explanation | Page |
|-----|---|--------------------|--|------|
| ① |  | Move key | Press these keys to move the pattern in the direction shown by the arrow. (Press the center key to return the pattern to the center of the embroidery area.) | E-15 |
| ② |  | Rotate key | Press this key to rotate the entire pattern. | E-15 |
| ③ |  | Embroidery key | Press this key to enter the embroidery screen. | - |
| ④ |  | Memory key | Press this key to save patterns to the machine's memory or USB flash drive. | E-31 |
| ⑤ |  | Trial key | Press this key to check the position of the pattern. The embroidery frame moves so you can check that there is enough space to sew pattern. For details, refer to "Checking the pattern position" in the "Basic operations" section. | - |
| ⑥ |  | Starting point key | Press this key to move the needle start position to align the needle with the pattern position. | E-15 |

Moving the pattern

Press  to move the entire pattern.

For details, refer to "Checking the pattern position" in the "Basic operations" section.

Rotating the pattern

Press  to rotate the entire pattern.

For details, refer to "Rotating the pattern" on page E-6.

Aligning the pattern and the needle

- **Example:** Aligning the lower left side of a pattern and the needle

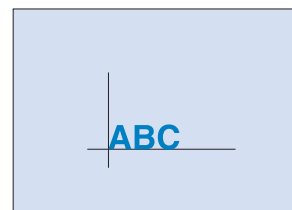

- 1 Mark the embroidery start position on the fabric, as shown.

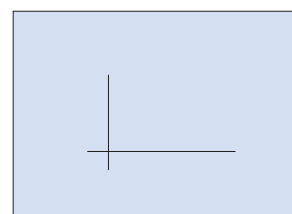

- 2 Press .

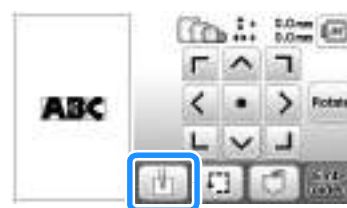

- 3 Press .



- ① Start position
- ② This key is used for aligning linked characters. (page E-16)

→ The needle position moves to the bottom left corner of the pattern (the embroidery frame moves so that the needle is positioned correctly).

- 4 Press .

- 5 Use  to align the needle and the mark on the fabric, and begin embroidering the pattern.

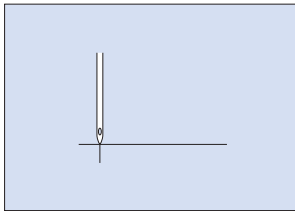

Embroidering linked characters

Follow the procedure described below to embroider linked characters in a single row when the entire pattern extends beyond the embroidery frame.

- Example: Linking "DEF" to the characters "ABC" using embroidery frame 10 cm x 10 cm (4 inches x 4 inches) (sold separately with some models)

A B C D E F

- 1 Select the character patterns for "ABC", and then press  and .





Note

- For details on selecting character patterns, refer to "Selecting character patterns" on page E-2.

- 2 Press .



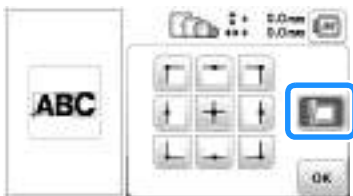

- 3 Press , and then press .



→ The needle is positioned in the lower-left corner of the pattern. The embroidery frame moves so that the needle is positioned correctly.



Note

- To cancel the starting point setting and return the starting point to the center of the pattern, press .
- Use  to select a different starting point for embroidering.

- 4 Press .

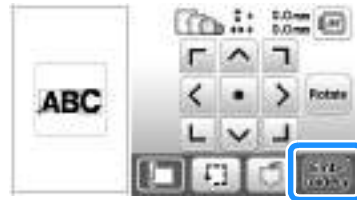

- 5 Lower the embroidery foot and then press the "Start/Stop" button to begin embroidering.

- 6 After the characters are embroidered, cut the threads, remove the embroidery frame, and then press  for "Finished embroidering".

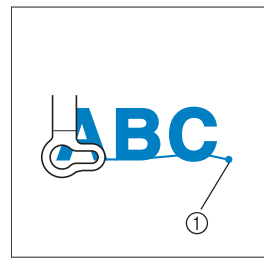

① End of the embroidering

- 7 Reposition the fabric in embroidery frame so that the right side of the letter "C" will be partially inside the embroidery frame; being careful so letters remain straight and level. Then reattach frame again so that the remaining characters ("DEF") can be embroidered.

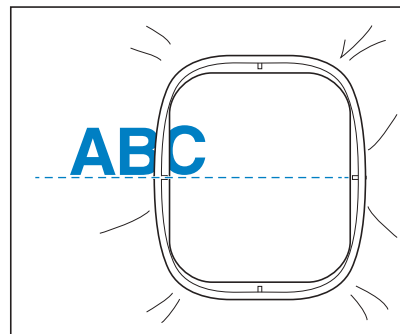

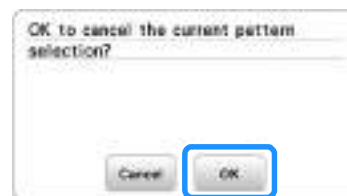

- 8 Press  and then press .



9 As in step 1, select the character patterns for “DEF”.

10 Press .

11 Press , and then press .

→ The needle is positioned in the lower-left corner of the pattern. The embroidery frame moves so that the needle is positioned correctly.

12 Use  to align the needle with the end of the embroidering for the previous pattern.

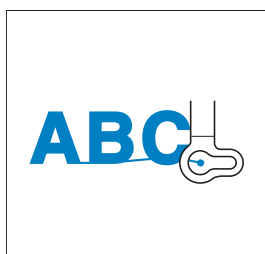

13 Press .



14 Lower the embroidery foot and press the “Start/Stop” button to begin embroidering the remaining character patterns.



Embroidery Applications

Sewing embroidery patterns which use appliqué

When the color sewing order display shows

 (APPLIQUE MATERIAL),
 (APPLIQUE POSITION) or
 (APPLIQUE), follow the procedure below.



1. Creating an appliqué piece
- ↓
2. Sewing the appliqué position on the base fabric
- ↓
3. Affixing the appliqué piece to the base fabric
- ↓
4. Embroidering the remainder of the pattern

Required materials

- Fabric for the appliqué piece
- Fabric for the appliqué base
- Stabilizer material
- Craft glue
- Embroidering thread



Note

- If  (APPLIQUE MATERIAL),  (APPLIQUE POSITION) or  (APPLIQUE) appear in the thread color list, the correct names and numbers of the thread colors to be used will not appear. Select the thread colors depending on those in the appliqué pattern.

1. Creating an appliqué piece

- 1 Select the appliqué pattern, and then continue to the embroidering screen.



- 2 Attach stabilizer material to the wrong side of the appliqué fabric.

Hoop the fabric in the embroidery frame, and then attach the embroidery frame to the embroidery unit.

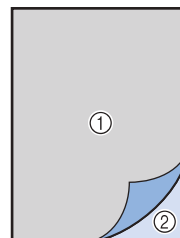

- ① Applique material (cotton, felt, etc.)
- ② Iron-on stabilizer

- 3 Thread the machine with the embroidery thread, lower the presser foot lever, and then press the "Start/Stop" button to sew the cutting line of the appliqué piece.

→ The outline of the appliqué piece is sewn, and then the machine stops.

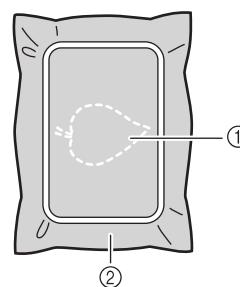

- ① Outline of applique
- ② Applique material

- 4 Remove the fabric for the appliqué piece from the embroidery frame, and then carefully cut along the sewn cutting line

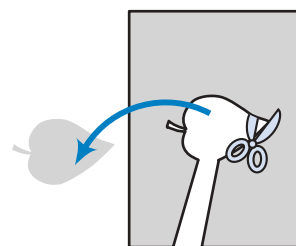

Note

- If the appliqué piece is cut out along the inside of the cutting line, it may not be correctly attached to the fabric. Therefore, carefully cut out the appliqué piece along the cutting line.
- After cutting out the appliqué piece, carefully remove the thread.

2. Sewing the appliqué position on the base fabric

- 1 Attach stabilizer material to the wrong side of the fabric for the appliqué base.
Hoop the fabric in the embroidery frame, and then attach the embroidery frame to the embroidery unit.
- 2 Thread the machine with the embroidery thread, lower the presser foot lever, and then press the "Start/Stop" button to sew the appliqué position.

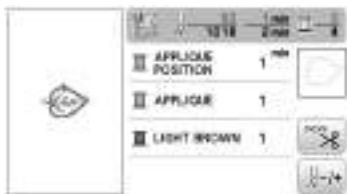

→ The position of the appliqué is sewn, and then the machine stops.

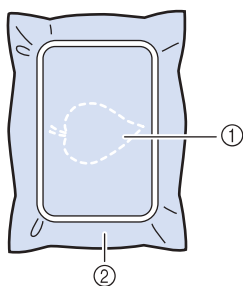

- 1 Position of applique
- 2 Base material

- 3 Remove the embroidery frame from the embroidery unit.



Note

- Do not remove the base fabric from the embroidery frame until all sewing is finished.

3. Affixing the appliqué piece to the base fabric

- 1 Lightly apply craft glue to the back of the appliqué piece, and then attach it to the base fabric within the outline of the position sewn in step 2 of "2. Sewing the appliqué position on the base fabric".

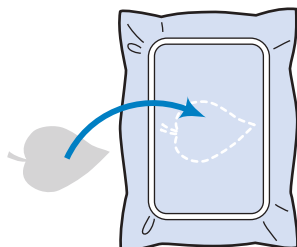

Note

- If the appliqué piece is not securely attached to the base fabric, the appliqué piece may lift off the base fabric during sewing, causing misalignment.
- If the appliqué piece cannot be attached to the base fabric with craft glue, securely baste it in place with basting stitches.
- If thin fabric is used for the appliqué piece, reinforce and secure it in place with an iron-on adhesive sheet. An iron can be used to attach the appliqué piece to the appliqué location.
- Before attaching the appliqué piece to the base fabric, do not remove the fabric from the embroidery frame.





- 2 After the appliqué piece is attached, attach the embroidery frame to the machine.
Thread the machine with the embroidery thread, lower the presser foot lever, and then press the "Start/Stop" button to sew the appliqué.

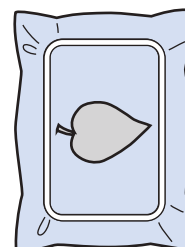

→ The appliqué piece is sewn to the base fabric, and then the machine stops.



Memo

- Depending on the pattern that is selected,  (APPLIQUE MATERIAL),  (APPLIQUE POSITION) and  (APPLIQUE) for all three steps may not appear. If  (APPLIQUE) appears as a color, embroider using thread of that color.

4. Embroidering the remainder of the pattern

- 1 Change the embroidery thread according to the thread color sewing order, and then finish embroidering the remainder of the pattern.



Memo

- Since glue may become attached to the presser foot, needle or needle plate, clean the glue off of the parts after finishing embroidering the appliqué pattern.
- For best results, trim all excess threads each time the thread color is changed.

Using a frame pattern to make an appliqué (1)

You can use framed patterns of the same size and shape to create an appliqué. Embroider one pattern with a straight stitch and one pattern with a satin stitch.

- 1 Select a straight stitch frame pattern. Embroider the pattern onto the appliqué material, then cut neatly around the outside of the shape.

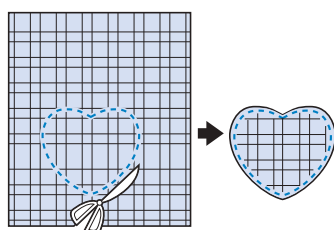
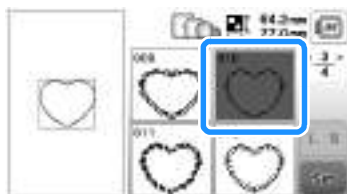

- 2 Embroider the same pattern from step 1 onto the base fabric.

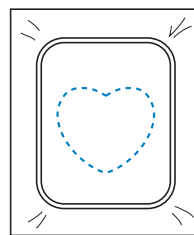

- 3 Apply a thin layer of fabric glue or a temporary spray adhesive to the rear of the appliqué created in step 1. Attach the appliqué to the base fabric matching the shapes.

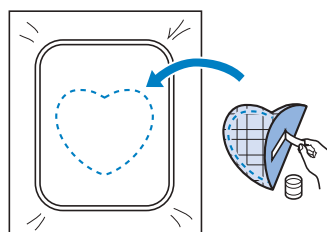

- 4 Select the satin stitch frame pattern of the same shape as the appliqué. Embroider over the appliqué and base fabric from step 3 to create the appliqué.

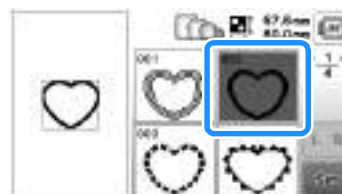

Note

- If you change the size or position of the patterns when selecting them, make a note of the size and location.

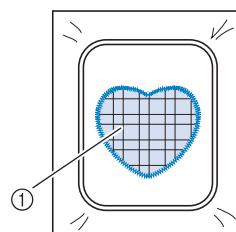

① Appliqué material

Using a frame pattern to make an appliqué (2)

This is a second method to make appliqué using embroidery patterns. You do not have to change the fabric in the embroidery frame using this method. Embroider one pattern with a straight stitch and one pattern with a satin stitch.

- 1 Select a straight stitch frame pattern, and embroider the pattern onto the base fabric.

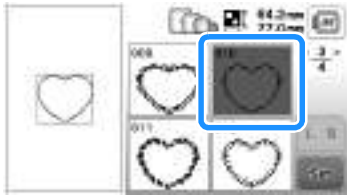

- 2 Place the appliqué fabric over the pattern embroidered in step 1.

- Be sure that the appliqué fabric completely covers the stitched line.

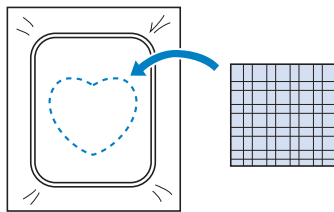

- 3 Embroider the same pattern on the appliqué fabric.

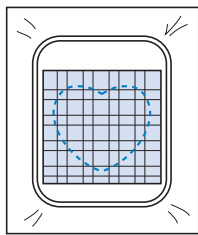

- 4 Remove the embroidery frame from the embroidery unit, and cut around the outside of the stitches.

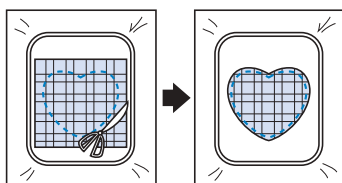

Note

- Do not remove the fabric from the embroidery frame to cut it. Also, do not pull or push on the fabric. Otherwise, the fabric may loosen in the frame.

- 5 Select the satin stitch frame pattern of the same shape as the appliqué.



Note

- Do not change the size or position of the pattern.
- If you change the size or position of the patterns when selecting them, make a note of the size and location.

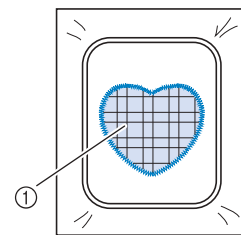

① Appliqué material

- 6 Reattach the embroidery frame to the embroidery unit, and embroider the satin stitch pattern to create an appliqué.

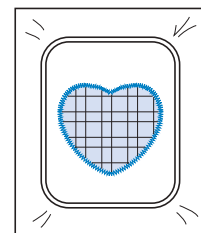

Sewing split embroidery patterns

Split embroidery patterns created with PE-DESIGN Ver.7 or later, or PE-DESIGN NEXT can be sewn. With split embroidery patterns, embroidery designs larger than the embroidery hoop are divided into multiple sections, which combine to create a single pattern after each section is sewn.

For details on creating split embroidery patterns and for more detailed sewing instructions, refer to the Instruction manual included with PE-DESIGN Ver.7 or later, or PE-DESIGN NEXT.

The following procedure describes how to read the split embroidery pattern shown below from USB flash drive and embroider it.

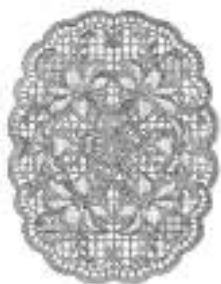



- 1 Insert the USB flash drive containing the created split embroidery pattern, and then select the split embroidery pattern to be embroidered.



- For details on recalling patterns, refer to “Recalling from USB flash drive” on page E-34.



→ A screen appears so that a section of the split embroidery pattern can be selected.

- 2 Select section  to be embroidered and press .



- Select the sections in alphabetical order.
- A maximum of 5 sections can be displayed in one page. If there are 6 or more sections in the pattern, press  or  to display the previous or next page.

- 3 If necessary, edit the pattern, and press .



- 4 Press .

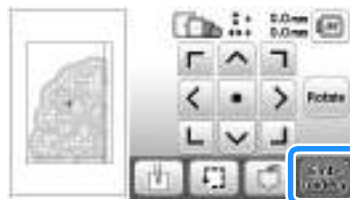

- For details on editing patterns, refer to “Editing All Patterns” on page E-15.

Memo

- Press  to rotate the pattern.

- 5 Press the “Start/Stop” button to embroider the pattern section.

- 6 When embroidering is finished, the following screen appears. Press .



→ A screen appears so that a section of the split embroidery pattern can be selected.

- 7 Repeat steps [2](#) through [6](#) to embroider the remaining sections of the pattern.



Adjustments During the Embroidery Process



Note

- Be careful not to bump the embroidery unit carriage or the presser foot when removing or attaching the embroidery frame. Otherwise, the pattern will not embroider correctly.

If the bobbin runs out of thread

When the bobbin begins to run out of thread during embroidering, the machine will stop and the message below will appear. Press  and follow the directions below to rethread the lower threading. If very little sewing remains, you can embroider approximately 10 final stitches without rethreading the machine by pressing . The machine will stop after sewing approximately 10 stitches.

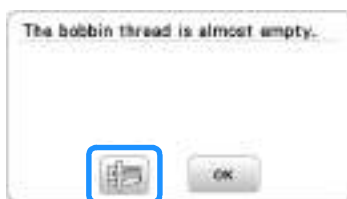

- 1 Press .

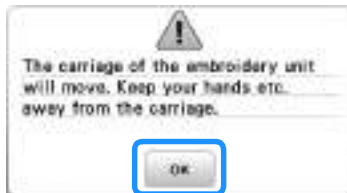

→ After the thread is automatically cut, the carriage will move.

- 2 **Unlock the frame-securing lever and remove the embroidery frame.**

- Be careful not to apply strong force to the fabric at this time. Otherwise, the fabric may loosen in the frame.

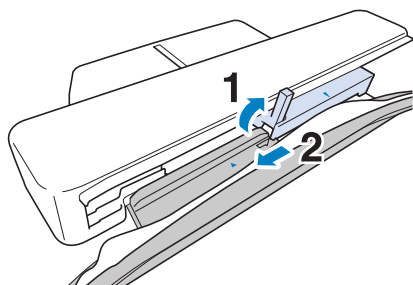

- 3 **Insert a wound bobbin into the machine.** (see “Setting the Bobbin” of “Basic operations”.)

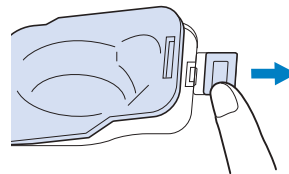

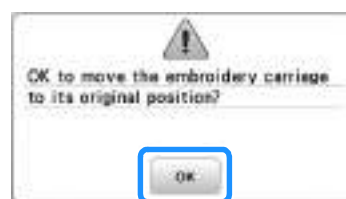

- 4 Press .





- 5 **Attach the embroidery frame.**

- 6 **To return to the area in the pattern where you stopped sewing, follow steps 3 through 6 in the next section.**

If the thread breaks during sewing



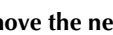

- 1 Press the “Start/Stop” button to stop the machine.
- 2 If the upper thread is broken, redo the upper threading. If the bobbin thread is broken, press  and follow the directions in steps 1 through 5 from the previous section to reset the bobbin.
- 3 Press .





- 4 Press , , or  to move the needle back the correct number of stitches before the area where the thread broke.



Memo

- If you cannot move back to the area where the thread broke, press  to select the color and move to the beginning position of that color, then use ,  or  to move ahead to slightly before where the thread broke.

- 5 Press  to return to the original screen.
- 6 Press  (Presser foot lifter button) to lower the presser foot, and press the “Start/Stop” button to continue sewing.

Restarting from the beginning

- 1 Press .



- 2 Press .



→ The embroidery frame moves, returning the needle to the pattern's beginning position.

- 3 Press  (Presser foot lifter button) to lower the presser foot and start sewing.

Resuming embroidery after turning off the power

The current color and stitch number are saved when embroidery is stopped. The next time the machine is turned on, you have the option to continue or delete the pattern.

Memo

- Even if the power goes out in the middle of embroidery, the machine returns to the point where embroidery was stopped when the machine is turned on again.



① Current stitch number when embroidery was stopped

Note

- Do not remove the embroidery unit or the memory will no longer remember your design.

- 1 Turn the main power to ON.
- 2 Follow the instructions shown on the screen and remove the embroidery frame.

→ The following message will appear.

3 Attach the embroidery frame and press .

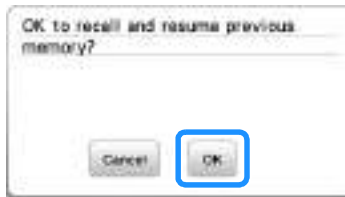

→ The previous embroidery screen displayed before the machine was turned off appears.



Memo

- If you want to start a new embroidery pattern, press  so the pattern selection screen appears.

4 Continue embroidering.

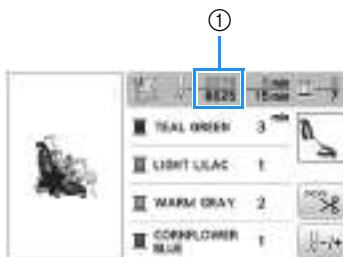

① Stitch number when embroidery is resumed

Making Embroidery Adjustments

Adjusting thread tension

When embroidering, the thread tension should be set so that the upper thread can slightly be seen on the wrong side of the fabric.

■ Correct thread tension

The pattern can be seen from the wrong side of the fabric. If the thread tension is not set correctly, the pattern will not finish well. The fabric may pucker or the thread may break.



- ① Right side
- ② Wrong side

Follow the operations described below to adjust thread tension according to the situation.



Note

- If the thread tension setting is made extremely weak, the machine may stop during sewing. This is not the sign of a malfunction. Increase the thread tension slightly, and begin sewing again.



Memo

- If you turn the main power to OFF or select a different pattern, the thread tension will reset to the automatic setting.
- When you retrieve a saved pattern, the thread tension setting will be the same as when the pattern was saved.

■ Upper thread is too tight

The tension of the upper thread is too tight, resulting in the bobbin thread being visible from the right side of the fabric.



Note

- If the bobbin thread was incorrectly threaded, the upper thread may be too tight. In this case, refer to “Setting the Bobbin” of “Basic operations” and rethread the bobbin thread.



- ① Right side
- ② Wrong side

1 Press .



2 Press  to weaken the upper thread tension. (The tension number will decrease.)

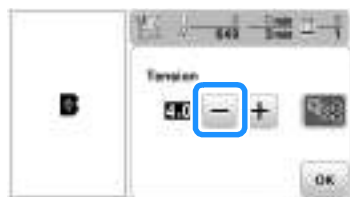

3 Press .

■ Upper thread is too loose

The tension of the upper thread is too loose, resulting in a loose upper thread, loose thread locks, or loops appearing on the right side of the fabric.



Note

- If the upper thread was incorrectly threaded, the upper thread may be too loose. In this case, refer to “Upper Threading” of “Basic operations” and rethread the upper thread.

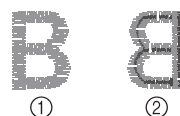

- ① Right side
- ② Wrong side

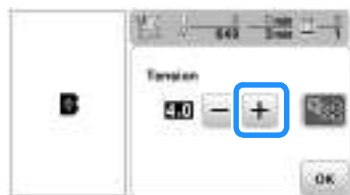

1 Press .

2 Press  to tighten the upper thread tension. (The tension number will increase.)



3 Press .

 **Note**

- With “Embroidery Tension” on the setting screen, the tension of the upper thread can be adjusted for embroidering. The selected setting will be applied to all patterns. When embroidering, if the overall tension of the upper thread is too tight or too loose, adjust it from the setting screen. Press  to tighten the upper thread tension and press  to loosen the upper tension. If an individual embroidery pattern needs additional fine tuning, refer to “Adjusting thread tension” on page E-26.

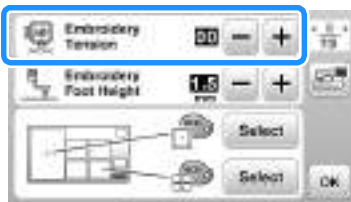

Adjusting the bobbin case (with no color on the screw)

The bobbin case (with no color on the screw) can be adjusted when bobbin tension changes are required to accommodate different bobbin threads. See “Embroidery Attractive Finishes” in the “Basic operations”.

To adjust the bobbin tension for embroidery function, using the bobbin case (with no color on the screw), turn the slotted-head screw (-) with a screwdriver (small).

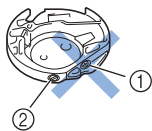

- ① Do not turn the phillips screw (+).
- ② Adjust with a screwdriver (small).

■ Correct tension

Upper thread slightly appears on the wrong side of fabric.

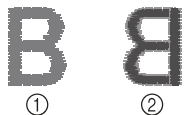

- ① Right side
- ② Wrong side

■ Bobbin thread is too loose

Bobbin thread appears slightly on the right side of fabric.



- ① Right side
- ② Wrong side

If this occurs, turn the slotted-head screw (-) clockwise, being careful not to over-tighten the screw, approximately 30-45 degrees to increase bobbin tension.

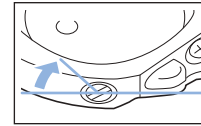

■ Bobbin thread is too tight

Upper thread on the right side of fabric seems to be lifting/looping and bobbin thread is not seen on the wrong side of fabric.



- ① Right side
- ② Wrong side

If this occurs, turn the slotted-head screw (-) counterclockwise, being careful not to over-loosen the screw, approximately 30-45 degrees to decrease bobbin tension.

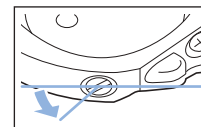

⚠ CAUTION

- When adjusting the bobbin case, be sure to remove the bobbin from the bobbin case.
- DO NOT adjust the position of the phillips (+) screw on the bobbin case as this may result in damage to the bobbin case, rendering it unusable.
- If the slotted-head screw (-) is difficult to turn, do not use force. Turning the screw too much or providing force in either (rotational) direction may cause damage to the bobbin case. Should damage occur, the bobbin case may not maintain proper tension.

Using the automatic thread cutting function (END COLOR TRIM)

The automatic thread cutting function will cut the thread at the end of sewing each color. This function is initially turned on. To turn this function off, press key and then . This function can be turned on or off during embroidering.

1 Press .



2 Press to turn off the automatic thread cutting function.

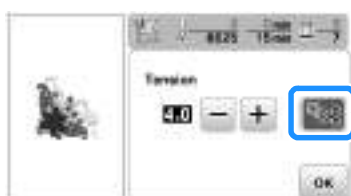

→ The key will display as .

- When one color thread is sewn, the machine will stop without cutting the thread.

3 Press to return to the original screen.

Adjusting the embroidery speed

1 Press to display the following screen.

2 Change the "Max Embroidery Speed" by pressing / .



3 Press to return to the original screen.

Memo

- "spm" is the number of stitches sewn in one minute.
- Decrease the embroidery speed when embroidering on thin, thick, or heavy fabrics.
- The sewing speed can be changed after an embroidery pattern has been started.
- The maximum embroidery speed setting does not change until a new setting is selected. The setting specified before the main power is set to OFF remains selected the next time that the machine is turned on.
- Decrease to a slower spm when using a special thread like a metallic thread.

Changing the "Embroidery Frame Display"

1 Press to display the following screen.

2 In the "Embroidery Frame Display", use / to change the embroidery frame display mode.

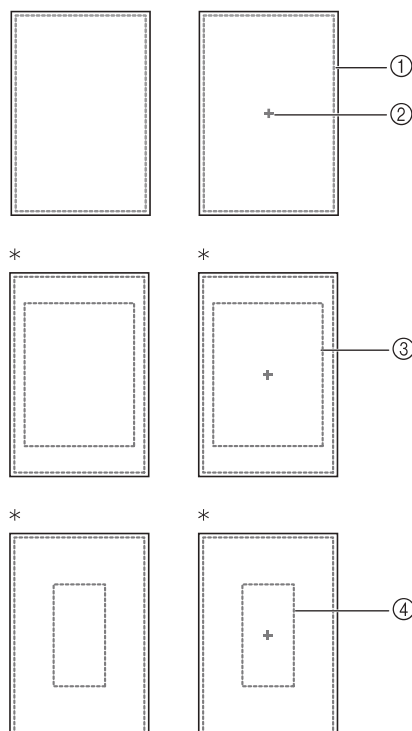
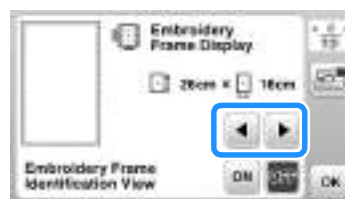

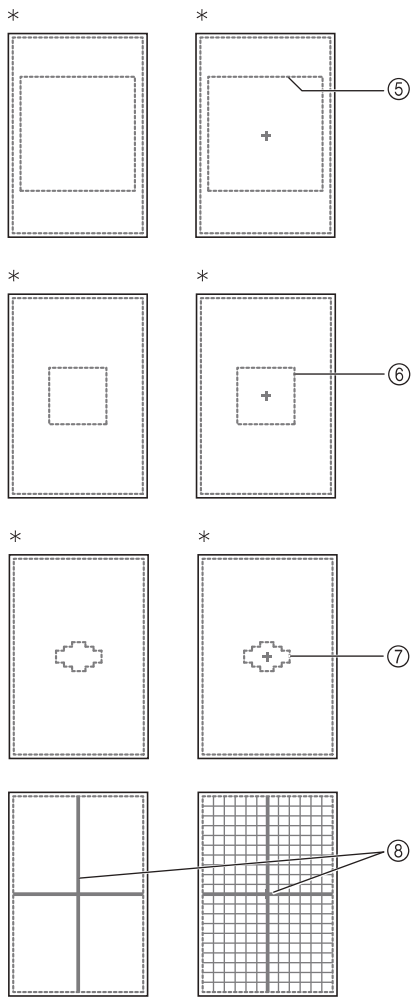

- * Sold separately with some models.
- ① Extra large frame embroidering area
26 cm×16 cm (10-1/4 inches × 6-1/4 inches)
 - ② Center mark
 - ③ Large frame embroidering area*
18 cm × 13 cm (7 inches × 5 inches)
 - ④ Embroidering area for border embroidery frame*
18 cm × 10 cm (7 inches × 4 inches)
 - ⑤ Embroidery area for quilt embroidery frame*
15 cm × 15 cm (6 inches × 6 inches)
 - ⑥ Medium frame embroidering area*
10 cm × 10 cm (4 inches × 4 inches)
 - ⑦ Embroidery area for small embroidery frame*
2 cm × 6 cm (1 inch × 2-1/2 inches)
 - ⑧ Grid lines

3 Press to return to the original screen.

Selecting/displaying patterns according to the embroidery frame size

If “Embroidery Frame Identification View” in the settings screen is set to “ON”, the pattern can be edited in the screen as if that embroidery frame is attached.

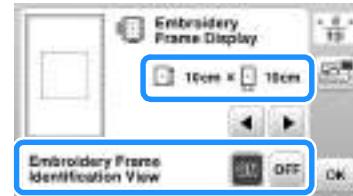

When “Embroidery Frame Identification View” is set to “OFF”.



- ① The embroidering area for the extra large frame is displayed.

When “Embroidery Frame Identification View” is set to “ON”.



- ① The embroidering area for the selected frame is displayed.
- ② Patterns that will not fit in the selected frame appear shaded and cannot be selected.

Memo

- Patterns that cannot be sewn in the selected embroidery frame will not be available in the pattern selection screen.
- The pattern will be enlarged or reduced within the embroidering area for the selected embroidery frame.
- When enlarging the pattern by pressing on the editing screen, it is enlarged to 100% of the size for the selected embroidery frame.

Changing the background colors of the embroidery patterns

In the settings screen, the background colors can be changed for the embroidery pattern and pattern thumbnails. Depending on the pattern color, select the desired background color from the 66 settings available. Different background colors can be selected for the embroidery pattern and pattern thumbnails.

1 Press  to display the following screen.

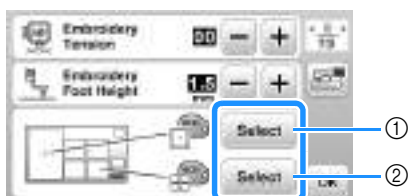

- ① Embroidery pattern background
- ② Pattern thumbnails background

2 Press .

3 Select the background color from the 66 available settings.

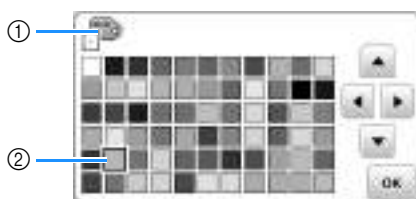

- ① Embroidery pattern background
- ② Selected color

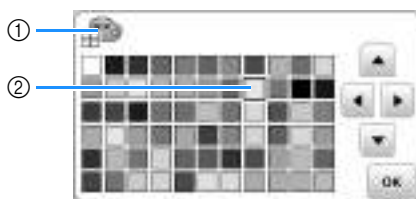

- ① Pattern thumbnails background
- ② Selected color

4 Press  twice to return to the original screen.

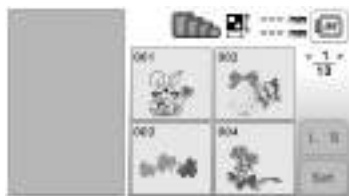

Memo



- The setting remains selected even if the machine is turned off.

Specifying the size of pattern thumbnails

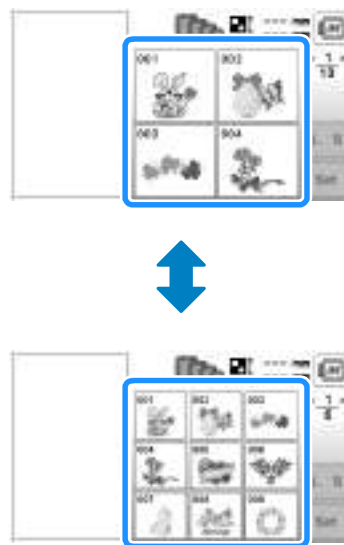
The thumbnails for selecting an embroidery pattern can be set to be displayed at the smaller size or a larger size. The larger size is 1.5 times the smaller size.



1 Press  to display the following screen.

2 Press  or  to select the desired thumbnail size.



3 Press  to return to the original screen.

Using the Memory Function

Embroidery data precautions

Observe the following precautions when using embroidery data other than that created and saved in this machine.

CAUTION

- When using embroidery data other than our original patterns, the thread or needle may break when sewing with a stitch density that is too fine or when sewing three or more overlapping stitches. In that case, use one of our original data design systems to edit the embroidery data.

■ Types of embroidery data that can be used

- Only .pes, .phc, and .dst embroidery data files can be used with this machine. Using data other than that saved using our data design systems or machines may cause the embroidery machine to malfunction.

■ Types of USB media that can be used

Stitch data can be saved to or recalled from a USB flash drive of any size.



Note

- The processing speed may vary by quantity of data stored.
- Only a USB flash drive can be connected to the USB port on this machine.
- The access lamp will begin blinking after inserting USB flash drive, and it will take about 5 to 6 seconds to recognize the drive. (Time will differ depending on the USB flash drive).
- For additional information, refer to the instruction manual included with the USB flash drive that you have purchased.



Memo

- To create file folders, use a computer.

■ Precautions on using the computer to create and save data

- If the name of the embroidery data file/folder cannot be identified, for example, because the name contains special characters, the file/folder is not displayed. If this occurs, change the name of the file/folder. We recommend using the 26 letters of the alphabet (uppercase and lowercase), the numbers 0 through 9, "-", and "_".
- If embroidery data larger than 26 cm × 16 cm (approx. 10-1/4 inches × 6-1/4 inches) is selected, the pattern will be displayed rotated by 90 degrees when it is read out. Even after being rotated 90 degrees, embroidery data larger than 26 cm × 16 cm (approx. 10-1/4 inches × 6-1/4 inches) cannot be used. (All designs must be within the 26 cm × 16 cm (approx. 10-1/4 inches × 6-1/4 inches) design field size.)
- .pes files saved with the number of stitches or the number of colors exceeding the specified limits cannot be displayed. The combined design can not exceed a maximum number of 400,000 stitches or a maximum number of 125 color changes (Above numbers are approximate, depending on the overall size of the design). Use one of our design software programs to edit the embroidery pattern so that it meets these specifications.
- Embroidery data stored in a folder created in USB flash drive can be retrieved.
- Even if the embroidery unit is not attached, the machine will recognize embroidery data.

■ Tajima (.dst) embroidery data

- .dst data is displayed in the pattern list screen by file name (the actual image cannot be displayed). Only the first eight characters of the file name can be displayed.
- Since Tajima (.dst) data does not contain specific thread color information, it is displayed with our default thread color sequence. Check the preview and change the thread colors as desired.

Saving embroidery patterns in the machine's memory

You can save embroidery patterns that you have customized and will use often; for example, your name, patterns that have been rotated or had the size changed, patterns that have had the sewing position changed, etc. A total of about 1 MB of patterns can be saved in the machine's memory.

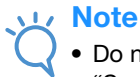

Note

- Do not turn the main power to OFF while the "Saving..." screen is displayed. You will lose the pattern you are saving.



Memo

- It takes a few seconds to save a pattern to the machine's memory.
- See page E-33 for information on retrieving a saved pattern.

- Press  when the pattern you want to save is in the pattern editing screen or embroidery settings screen.



- Press .

- Press  to return to the original screen without saving.



→ The "Saving..." screen is displayed. When the pattern is saved, the display returns to the original screen automatically.

If the memory is full

If the following screen appears, either the maximum number of patterns have been saved or the pattern you want to save uses a lot of memory, and the machine cannot save it. If you delete a previously saved pattern, you can save the current pattern.

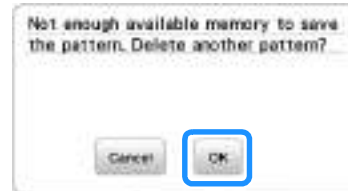

- Press .

- Press  to return to the original screen without saving.



→ The machine displays the patterns currently saved.

- Select the pattern you want to delete.

- Press   to move to the previous/next page.



- Press .

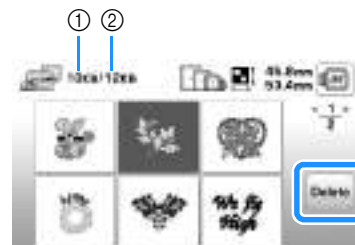

- Amount of memory used by the pattern to be deleted
- Amount of machine's memory

- Press .

- If you decide not to delete the pattern, press .

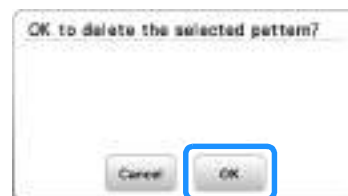

→ The "Saving..." screen displays. When the pattern is saved, the display returns to the original screen automatically.



Note

- Do not turn the main power to OFF while the "Saving..." screen is displayed. You will lose the pattern you are saving.

Memo

- If there is enough memory available after deleting the pattern, the pattern you want to save will be saved automatically. If there is not enough memory available after deleting the pattern, repeat the steps above to delete another pattern from the machine's memory.
- It takes a few seconds to save a pattern.
- See page E-33 for more information about retrieving saved patterns.

Saving embroidery patterns to USB flash drive

When sending embroidery patterns from the machine to USB flash drive, plug the USB flash drive into the machine's USB port.

Memo

- USB flash drive is commercially available, but some USB flash drive may not be usable with this machine. Please visit our website for more details.
- The USB flash drive can be inserted or removed at any time except while saving or deleting a pattern.

- 1 Press  when the pattern you want to save is in the pattern editing screen or embroidery settings screen.



- 2 Insert the USB flash drive into the USB port on the machine.

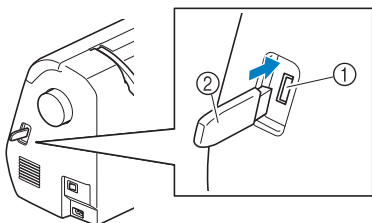

- ① USB port
- ② USB flash drive

Note

- The processing speed may vary by quantity of data.
- Do not insert anything other than USB flash drive into the USB port. Otherwise, the USB flash drive may be damaged.

- 3 Press .

- Press  to return to the original screen without saving.



- The "Saving..." screen is displayed. When the pattern is saved, the display returns to the original screen automatically.
- The pattern is saved in a folder labeled "bPocket".

Note

- Do not insert or remove USB flash drive while "Saving..." screen is displayed. You will lose some or all of the pattern you are saving.



Retrieving patterns from the machine's memory

- 1 Press .



- The machine displays the patterns currently in the memory.

- 2 Press the key of the pattern you want to retrieve.

- Press   to move to the previous/next page.
- Press  to return to the original screen.



Memo

- The selected pattern can be saved to USB flash drive directly by pressing .

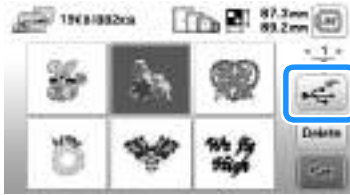

3 Press .

→ Pattern editing screen is displayed.



4 Adjust the pattern as desired, and then begin embroidering.

Recalling from USB flash drive

You can recall a specific embroidery pattern from either direct USB flash drive or a folder in the USB flash drive. If the pattern is in a folder, check each folder to find the embroidery pattern.

Note

- The processing speed may vary by quantity of data.



1 Insert the USB flash drive into the USB port on the machine (see page E-33).

2 Press .



→ Embroidery patterns and a folder in a top folder are displayed.

3 Select the pattern. If the stitch pattern to be retrieved is in a folder, press the key for that folder.

- Press  to move to the previous/next page.
- Press  to return to the original screen without recalling.





→ Stitch patterns within a folder are displayed.



- The folder name or the path to show the current folder is displayed under the folder icon. Embroidery patterns and subfolders within a folder are displayed.
- Press  to return to the previous screen.
- Use the computer to create folders. Folders cannot be created with the machine.

4 Press the key of the pattern you want to retrieve.

- Press  to move to the previous/next page.
- Press  to return to the original screen.

5 Press .



- Press  to delete the pattern. The pattern will be deleted from the USB flash drive.
- Pattern editing screen is displayed.

Memo

- The selected pattern can be saved to the machine's memory directly by pressing .



- 6 If necessary, edit the pattern, and press .



→ Embroidery settings screen is displayed.

- 7 Press .

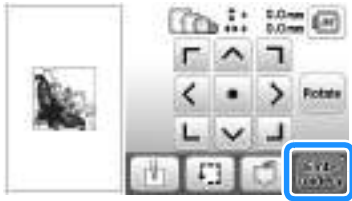

→ The embroidery screen is displayed.

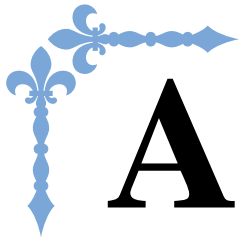

Appendix

This section provides important information for operating this machine. Please read this section to find troubleshooting tips and pointers as well as how to keep your machine in the best working order. Page number starts with "A" in this section.

Chapter1 MAINTENANCE AND TROUBLESHOOTING.....A-2

Chapter 1 MAINTENANCE AND TROUBLESHOOTING

Care and Maintenance

Restrictions on oiling

In order to prevent damaging this machine, it must not be oiled by the user.

This machine was manufactured with the necessary amount of oil applied to ensure correct operation, making periodic oiling unnecessary.

If problems occur, such as difficulty turning the handwheel or an unusual noise, immediately stop using the machine, and contact your authorized Brother dealer or the nearest Brother authorized service center.

Precautions on storing the machine

Do not store the machine in any of the locations described below, otherwise damage to the machine may result, for example, rust caused by condensation.

- Exposed to extremely high temperatures
- Exposed to extremely low temperatures
- Exposed to extreme temperature changes
- Exposed to high humidity or steam
- Near a flame, heater or air conditioner
- Outdoor or exposed to direct sunlight
- Exposed to extremely dusty or oily environments



Note

- In order to extend the life of this machine, periodically turn it on and use it. Storing this machine for an extended period of time without using it may reduce its efficiency.

Cleaning the LCD Screen

If the screen is dirty, gently wipe it with a soft, dry cloth. Do not use organic solvents or detergents.



Note

- Do not wipe the LCD screen with a damp cloth.



Memo

- Occasionally, condensation may form on the LCD screen or it may become fogged up; however, this is not a malfunction. After a while, the cloudiness will disappear.

Cleaning the machine surface

If the surface of the machine is dirty, lightly soak a cloth in neutral detergent, squeeze it out firmly, and then wipe the surface of the machine. After cleaning it once with a damp cloth, wipe it again with a dry cloth.

⚠ CAUTION

- **Unplug the power cord before cleaning the machine, otherwise injuries or an electric shock may occur.**

Cleaning the race

Sewing performance will suffer if lint and dust collects in the bobbin case, therefore, it should be cleaned regularly.

- 1 Press  (Needle position button) to raise the needle.
- 2 Turn off the machine.
- 3 Unplug the power cord from the power supply jack on the right side of the machine.

⚠ CAUTION

- **Unplug the power cord before cleaning the machine, otherwise injuries or an electric shock may occur.**

- 4 Raise the presser foot to remove the needle, presser foot and presser foot holder.
 - For details, refer to "Replacing the needle" and "Replacing the presser foot" in the "Basic operations" section.
- 5 Remove the flat bed attachment or the embroidery unit if either is attached.
- 6 Remove the needle plate cover.

■ **If there is a screw in the needle plate cover**

- 1 Use the L-shaped (or disc-shaped) screwdriver to remove the screw in the needle plate cover.

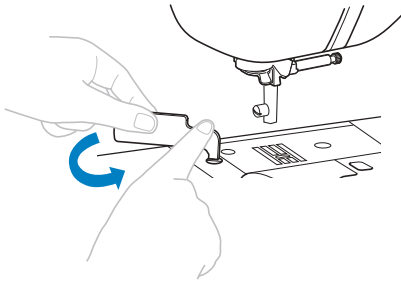

- 2 Grasp both sides of the needle plate cover, and then slide it toward you.

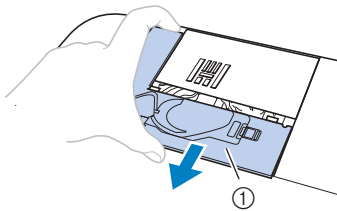

① Needle plate cover

■ **If there is no screw in the needle plate cover**

- 1 Grasp both sides of the needle plate cover, and then slide it toward you.

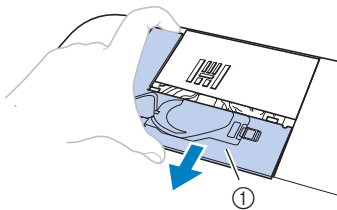

① Needle plate cover

7 **Remove the bobbin case.**

- Grasp the bobbin case, and then pull it out.

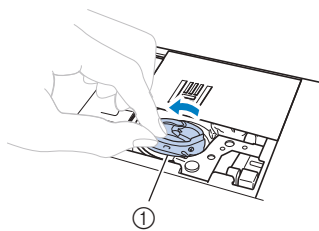

① Bobbin case

- 8 Use the cleaning brush or a vacuum cleaner to remove any lint and dust from the race and bobbin thread sensor and the surrounding area.

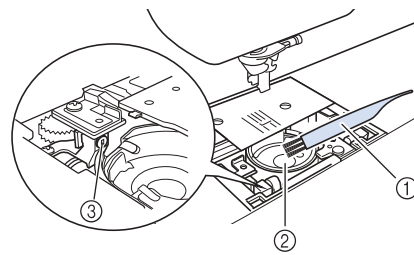

- ① Cleaning brush
- ② Race
- ③ Bobbin thread sensor

- Do not apply oil to the bobbin case.

- 9 Insert the bobbin case so that the ▲ mark on the bobbin case aligns with the ● mark on the machine.

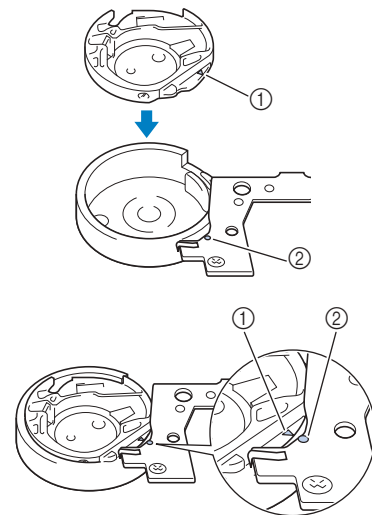

- Align the ▲ and ● marks.

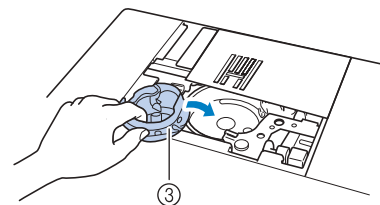

- ① ▲ mark
- ② ● mark
- ③ Bobbin case

- Make sure that the indicated points are aligned before installing the bobbin case.



- 10 Insert the tabs on the needle plate cover into the needle plate, and then slide the cover back on.

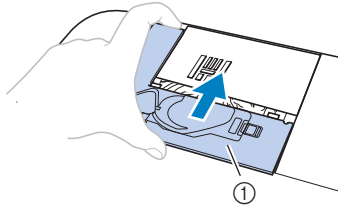

① Needle plate cover

CAUTION

- Never use a bobbin case that is scratched, otherwise the upper thread may become tangled, the needle may break or sewing performance may suffer. For a new bobbin case, contact your nearest Brother authorized service center.
- Be sure that the bobbin case is correctly installed, otherwise the needle may break.

About the maintenance message



Once this message appears, it is recommended to take your machine to an authorized Brother dealer or nearest Brother authorized service center for a regular maintenance check. Although this message will disappear and the machine will continue to function once you press **OK**, the message will display several more times until the appropriate maintenance is performed. Please take the time to arrange the maintenance your machine requires once this message appears. Such steps will help to ensure you receive continued, uninterrupted hours of machine operation for the future.

Touch panel is malfunctioning

If the screen does not respond correctly when you touch a key (the machine does not perform the operation or performs a different operation), follow the steps below to make the proper adjustments.

- 1 Holding your finger on the screen, turn the main power switch to OFF and back to ON.

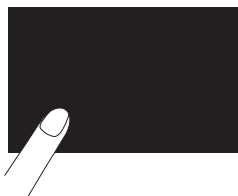

→ The touch panel adjustment screen is displayed.

- 2 Lightly touch the center of each +, in order from 1 to 5.



Note

- Do not press too hard on the screen. Otherwise, damage may result.

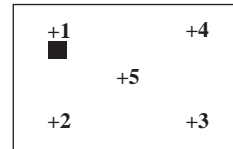

- 3 Turn the main power to OFF, then turn it back to ON.



Note

- If you finish the screen adjustment and the screen still does not respond, or if you cannot do the adjustment, contact your authorized Brother dealer.

Operation beep

Each time a key is pressed you will hear one beep. If an incorrect operation is performed you will hear two or four beeps.

- **If a key is pressed (correct operation)**
One beep sounds.
- **If an incorrect operation is performed**
Two or four beeps sound.
- **If the machine locks up, for example, because the thread is tangled**
The machine beeps for four seconds and the machine automatically stops.
Be sure to check for the cause of the error and correct it before continuing to sew.

■ Canceling the operation beep

- 1 Press **Menu** to display the settings screen.
- 2 Display page 8.
- 3 Set "Buzzer" to "OFF."



Troubleshooting

If the machine stops operating correctly, check the following possible problems before requesting service. You can solve most problems by yourself. If you need additional help, the Brother Solutions Center offers the latest FAQs and troubleshooting tips. Visit us at “ <http://support.brother.com/> ”. If the problem persists, contact your Brother dealer or the nearest Brother authorized service center.

Frequent troubleshooting topics

Detailed causes and remedies for common troubleshooting topics are described below. Be sure to refer to this before contacting us.

| | |
|--|-----------|
| Upper thread tightened up | page A-5 |
| Tangled thread on wrong side of fabric | page A-6 |
| Incorrect thread tension | page A-7 |
| Fabric is caught in the machine and cannot be removed | page A-8 |
| When the thread becomes tangled under the bobbin winder seat | page A-11 |

Upper thread tightened up

Symptom

- The upper thread appears as a single continuous line.
- The lower thread is visible from the upper side of the fabric. (Refer to the illustration below.)
- The upper thread has tightened up, and comes out when pulled.
- The upper thread has tightened up, and wrinkles appear in the fabric.
- The upper thread tension is tight, and the results do not change even after the thread tension is adjusted.

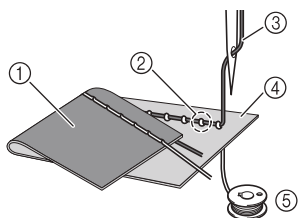

- ① Wrong side of fabric
- ② Bobbin thread visible from right side of fabric
- ③ Upper thread
- ④ Right side of fabric
- ⑤ Bobbin thread

Cause

Incorrect bobbin threading

If the bobbin thread is incorrectly threaded, instead of the appropriate tension being applied to the bobbin thread, it is pulled through the fabric when the upper thread is pulled up. For this reason, the thread is visible from the right side of the fabric.

Remedy/check details

Correctly install the bobbin thread.

- 1 Press and raise the presser foot lever.
- 2 Remove the bobbin from the bobbin case.
- 3 Place the bobbin in the bobbin case so that the thread unwinds in the correct direction.
 - Hold the bobbin with your right hand with the thread unwinding to the left, and hold the end of the thread with your left hand. Then, with your right hand, place the bobbin in the bobbin case.

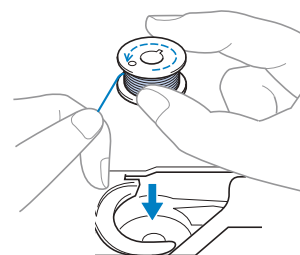

If the bobbin is inserted with the thread unwinding in the wrong direction, sewing will be done with an incorrect thread tension.

- 4 While holding the bobbin in place with your finger, pass the thread through the slit in the needle plate cover.

- Hold down the bobbin with your right hand, and then pull the end of the thread around the tab with your left hand.

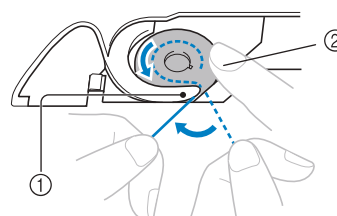

- ① Tab
- ② Hold down the bobbin with your right hand.

Pull the thread to pass it through the slit in the needle plate cover, then cut it with the cutter.

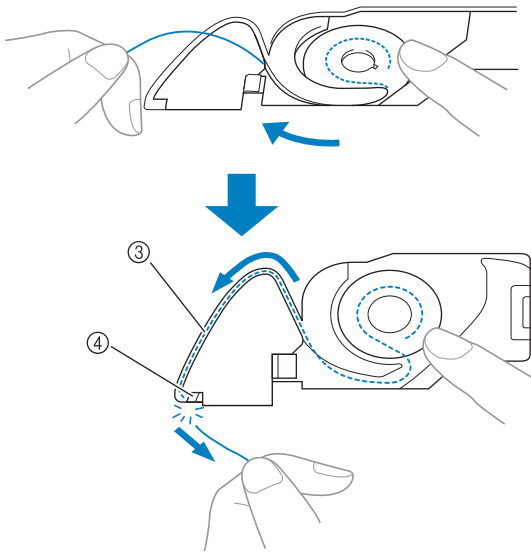

- ③ Slit
- ④ Cutter

Sewing with the correct thread tension is possible after the bobbin has been correctly installed in the bobbin case.

- 5 Press to unlock all keys and buttons.

Tangled thread on wrong side of fabric

Symptom

- The thread becomes tangled on the wrong side of the fabric.

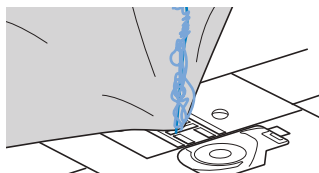

- After starting sewing, a rattling noise is made and sewing cannot continue.
- Looking under the fabric, there is tangled thread in the bobbin case.

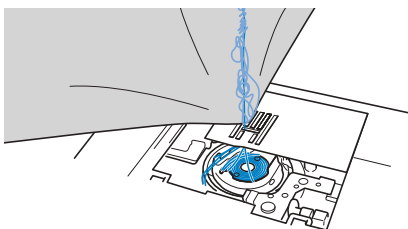

Cause

Incorrect upper threading

If the upper thread is incorrectly threaded, the upper thread passed through the fabric cannot be firmly pulled up and the upper thread becomes tangled in the bobbin case, causing a rattling noise.

Remedy/check details

Remove the tangled thread, and then correct the upper threading.

- 1 Remove the tangled thread. If it cannot be removed, cut the thread with scissors.
 - For details, refer to “Cleaning the race” on page A-2.
- 2 Remove the upper thread from the machine.
 - If the bobbin was removed from the bobbin case, refer to “Installing the bobbin” in the “Basic operations” section and “Remedy/check details” in the section “Upper thread tightened up” on page A-5 to correctly install the bobbin.
- 3 Refer to the following steps to correct the upper threading. Raise the presser foot using the presser foot lever.

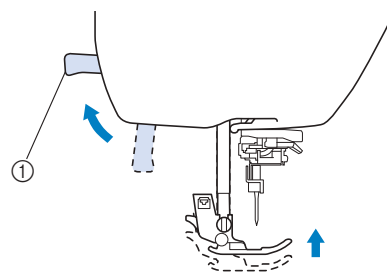

- ① Presser foot lever

→ The upper thread shutter opens so the machine can be threaded.

- If the presser foot is not raised, the machine cannot be threaded correctly.

- 4 Press (Needle position button) once or twice to raise the needle.

→ The needle is correctly raised when the mark on the handwheel is at the top, as shown below. Check the handwheel and, if this mark is not at this position, press (Needle position button) until it is.

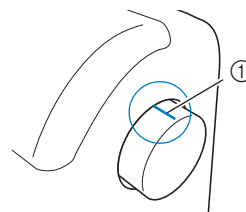

- ① Mark on handwheel

- 5 While holding the thread lightly with your right hand, pull the thread with your left hand, and then pass the thread behind the thread guide cover and to the front.

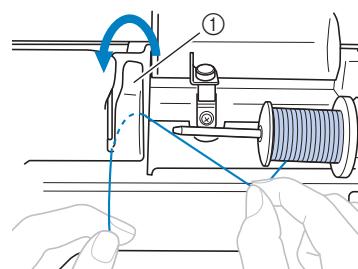

- ① Thread guide cover

- 6 Pass the thread under the thread guide plate, and then pull it up.

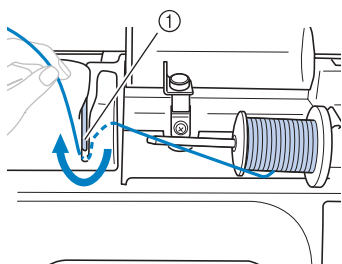

① Thread guide plate

- 7 While using your right hand to lightly hold the thread passed under the thread guide plate, pass the thread through the thread path in the order shown below.

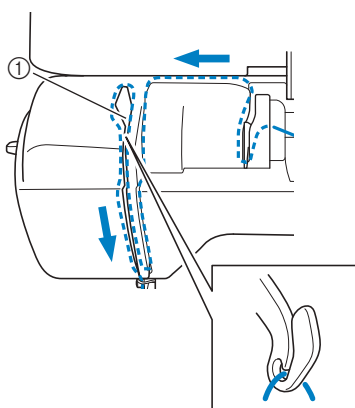

① Shutter

- 8 Press .

- 9 Slide the thread behind the needle bar thread guide.

The thread can easily be passed behind the needle bar thread guide by holding the thread in your left hand, then feeding the thread with your right hand, as shown.

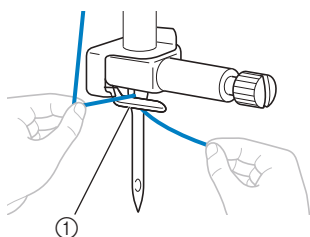

① Needle bar thread guide

- 10 Next, use the needle threader to thread the needle. Continue with the procedure in "Threading the needle" in the "Basic operations" section.

Incorrect thread tension

■ Symptoms

- Symptom 1: The bobbin thread is visible from the right side of the fabric. (Refer to illustration below)
- Symptom 2: The upper thread appears as a straight line on the right side of the fabric.
- Symptom 3: The upper thread is visible from the wrong side of the fabric. (Refer to illustration below)
- Symptom 4: The bobbin thread appears as a straight line on the wrong side of the fabric.
- Symptom 5: The stitching on the wrong side of the fabric is loose or has slack.

□ Symptom 1

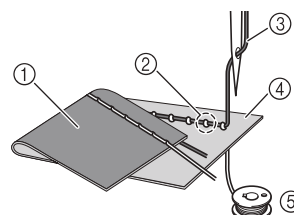

□ Symptom 3

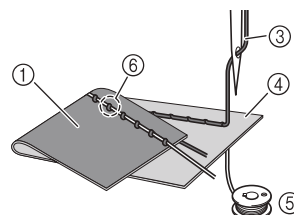

- ① Wrong side of fabric
- ② Bobbin thread visible from right side of fabric
- ③ Upper thread
- ④ Right side of fabric
- ⑤ Bobbin thread
- ⑥ Upper thread visible from wrong side of fabric

■ Cause/remedy/check details

□ Cause 1

The machine is not correctly threaded.

<With symptoms 1 and 2 described above>

The bobbin threading is incorrect.

Return the upper thread tension to the standard setting, and then refer to "Upper thread tightened up" on page A-5 to correct the threading.

<With symptoms 3 and 5 described above>

The upper threading is incorrect.

Return the upper thread tension to the standard setting, and then refer to "Tangled thread on wrong side of fabric" on page A-6 to correct the upper threading.

□ Cause 2

A needle and thread appropriate for the fabric are not being used.

The machine needle that should be used depends on the type of fabric sewn and the thread thickness.

If a needle and thread appropriate for the fabric are not being used, the thread tension will not be adjusted correctly, causing wrinkles in the fabric or skipped stitches.

- Refer to “Fabric/thread/needle combinations” in the “Basic operations” section to check that a needle and thread appropriate for the fabric are being used.

□ Cause 3

An appropriate upper tension is not selected.

The setting selected for the upper thread tension is not appropriate.

Refer to “Setting the thread tension” in the “Basic operations” section to select an appropriate thread tension.

The appropriate thread tension differs depending on the type of fabric and thread being used.

- * Adjust the thread tension while test sewing on a piece of scrap fabric that is the same as that used in your project.



Note

- If the upper threading and bobbin threading are incorrect, the thread tension cannot be adjusted correctly. Check the upper threading and bobbin threading first, and then adjust the thread tension.

- If the bobbin thread is visible from the right side of the fabric

Press **-** in the manual adjustment screen to decrease the tension of the upper thread.



- If the upper thread is visible from the wrong side of the fabric

Press **+** in the manual adjustment screen to increase the tension of the upper thread.



Fabric is caught in the machine and cannot be removed

If the fabric is caught in the machine and cannot be removed, the thread may have become tangled under the needle plate. Follow the procedure described below to remove the fabric from the machine. If the operation could not be completed according to the procedure, instead of attempting to complete it forcefully, contact your nearest Brother authorized service center.

■ Removing the fabric from the machine

1 Immediately stop the machine.

2 Turn off the machine.

3 Remove the needle.

If the needle is lowered into the fabric, turn the handwheel away from you (clockwise) to raise the needle out of the fabric, and then remove the needle.

- Refer to “Replacing the needle” in the “Basic operations” section.

4 Remove the presser foot and presser foot holder.

- Refer to “Replacing the presser foot” and “Removing and attaching the presser foot holder” in the “Basic operations” section.

5 Lift up the fabric and cut the threads below it.

If the fabric can be removed, remove it. Continue with the following steps to clean the race.

6 Remove the needle plate cover.

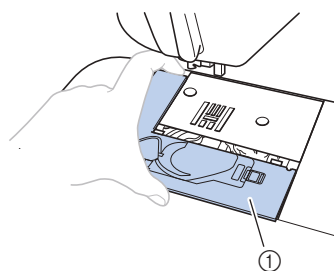

① Needle plate cover

- Refer to “Cleaning the race” on page A-2.

7 Cut out the tangled threads, and then remove the bobbin.

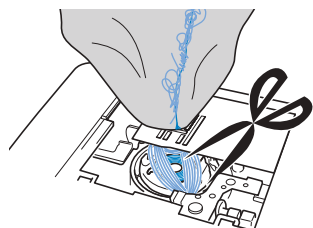

- 8 Remove the bobbin case.**
If threads remain in the bobbin case, remove them.

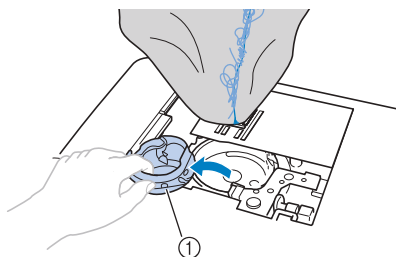

① Bobbin case

- 9 Use the cleaning brush or a vacuum cleaner to remove any lint or dust from the race and its surrounding area.**

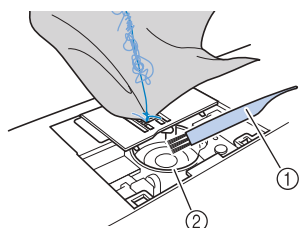

① Cleaning brush
② Race

| | |
|-------------------------------------|--------------------------------|
| If the fabric could be removed. | Continue with step 16 . |
| If the fabric could not be removed. | Continue with step 10 . |

- 10 Use the included L-shaped (or disc-shaped) screwdriver to loosen the two screws on the needle plate.**

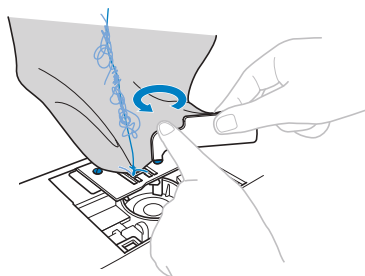

Note

- Be careful not to drop the removed screws in the machine.

- 11 Slightly lift up the needle plate, cut any tangled threads, and then remove the needle plate.**

Remove the fabric and threads from the needle plate.

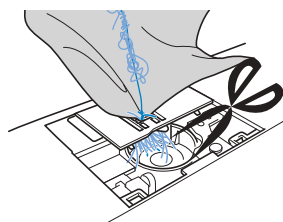

If the fabric cannot be removed, even after completing these steps, contact your nearest Brother authorized service center.

- 12 Remove any threads in the race and around the feed dogs.**

- 13 Turn the handwheel to raise the feed dogs.**

- 14 Align the two screw holes in the needle plate with the two holes at the needle plate mounting base, and then fit the needle plate onto the machine.**

- 15 Lightly finger-tighten the screw on the right side of the needle plate. Then, use the L-shaped (or disc-shaped) screwdriver to firmly tighten the screw on the left side. Finally, firmly tighten the screw on the right side.**

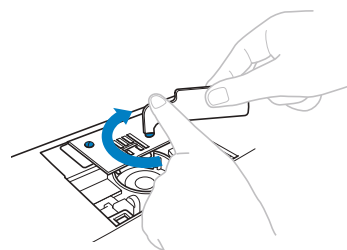

Turn the handwheel to check that the feed dogs move smoothly and do not contact the edges of the slots in the needle plate.

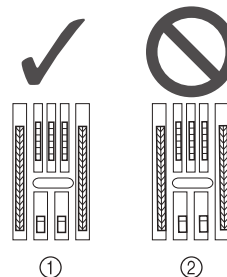

- ① Correct position of feed dogs
② Incorrect position of feed dogs



Note

- Be careful not to drop the removed screws in the machine.

- 16** Insert the bobbin case so that the ▲ mark on the bobbin case aligns with the ● mark on the machine.

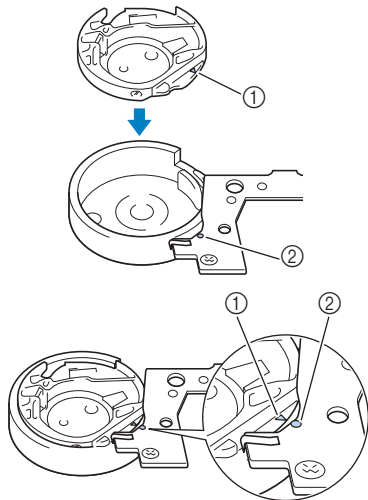

- Align the ▲ and ● marks.

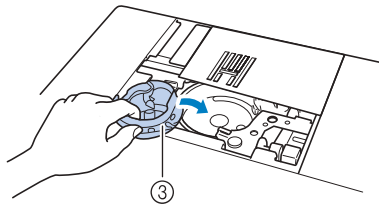

- ① ▲ mark
- ② ● mark
- ③ Bobbin case

- Make sure that the indicated points are aligned before installing the bobbin case.

⚠ CAUTION

- Never use a bobbin case that is scratched, otherwise the upper thread may become tangled, the needle may break or sewing performance may suffer.
- Make sure that you fit the bobbin case properly, otherwise the needle may break.

- 17** Attach the needle plate cover according to step 10 in “Cleaning the race” on page A-2.

- 18** Check the condition of the needle, and then install it. If the needle is in a poor condition, for example, if it is bent, be sure to install a new needle.

- Refer to “Checking the needle” and “Replacing the needle” in the “Basic operations” section.

⚠ CAUTION

- Never use bent needles. Bent needles can easily break, possibly resulting in injuries.



Note

- After completing this procedure, continue with the following procedure in “Checking machine operations” to check that the machine is operating correctly.



Memo

- Since the needle may have been damaged when the fabric was caught in the machine, we recommend replacing it with a new one.

■ Checking machine operations

If the needle plate has been removed, check machine operations to confirm that installation has been completed correctly.

- 1** Turn on the machine.

- 2** Select stitch .



Note

- Do not yet install the presser foot and thread.

- 3** Slowly turn the handwheel toward you (counterclockwise), and look from all sides to check that the needle falls at the center of the opening in the needle plate.

If the needle contacts the needle plate, remove the needle plate, and then install it again, starting with step 13 in “Removing the fabric from the machine” on page A-8.

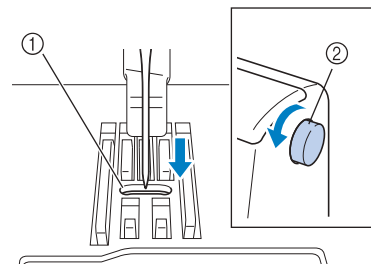

- ① Opening in the needle plate
- ② Handwheel

- 4** Select stitch . At this time, increase the stitch length and width to their maximum settings.

- For details on changing the settings, refer to “Setting the stitch width” and “Setting the stitch length” in the “Basic operations” section.

- 5** Slowly turn the handwheel toward you (counterclockwise) and check that the needle bar and feed dogs operate correctly.

If the needle or feed dogs contact the needle plate, the machine may be malfunctioning; therefore, contact your nearest Brother authorized service center.

6 Turn off the machine, and then install the bobbin and presser foot.

- Refer to “Installing the bobbin” and “Replacing the presser foot” in the “Basic operations” section.

7 Correctly thread the machine.

- For details on threading the machine, refer to “Upper Threading” in the “Basic operations” section.

Memo

- The thread may have become tangled as a result of incorrect upper threading. Make sure that the machine is correctly threaded.

8 Perform trial sewing with cotton fabric.

Note

- Incorrect sewing may be the result of incorrect upper threading or sewing thin fabrics. If there are poor results from the trial sewing, check the upper threading or the type of fabric being used.

When the thread became tangled under the bobbin winder seat

If the bobbin winding starts when the thread is not passed under the pretension disk of the bobbin-winding thread guide correctly, the thread may become tangled under the bobbin winder seat.

In such a case, wind off the thread according to the following procedure.

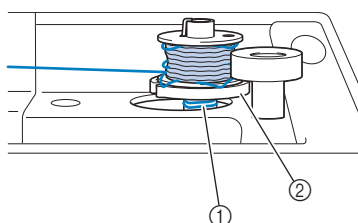

- ① Thread
- ② Bobbin winder seat

CAUTION

- Do not remove the bobbin winder seat even if the thread become tangled under the bobbin winder seat. It may result in injuries.
- Do not remove the screw on the bobbin winder guide post, otherwise the machine may be damaged; you cannot wind off the thread by removing the screw.

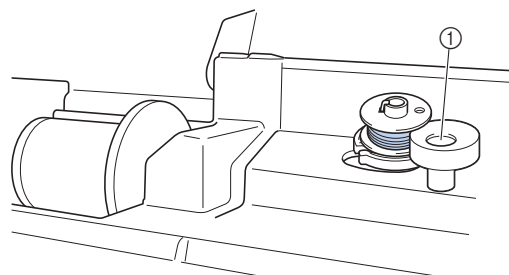

① Screw of the bobbin winder guide post

1 If the thread become tangled under the bobbin winder seat, press the “Start/Stop” button once to stop the bobbin winding.

When the foot controller is plugged in, remove your foot from the foot controller.

2 Cut the thread with scissors beside the bobbin-winding thread guide.

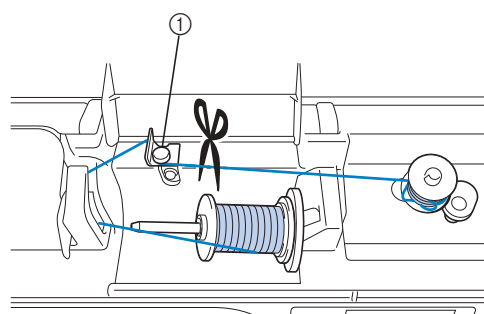

① Bobbin-winding thread guide

3 Slide the bobbin winder shaft to the left, and then remove the bobbin from the shaft and cut the thread leading to the bobbin in order to be able to completely remove the bobbin from shaft.

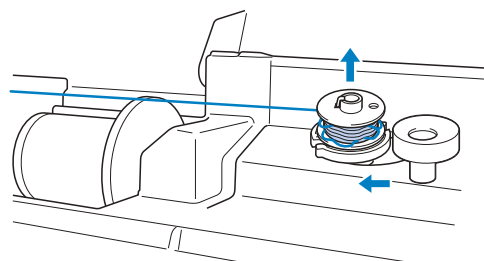

- 4 Hold the thread end with your left hand, and wind off the thread clockwise with your right hand as shown below.

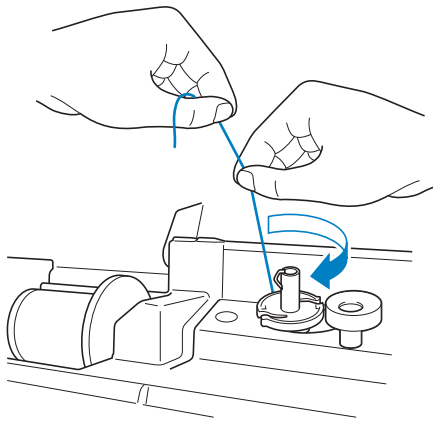

- 5 Wind the bobbin again.



Note

- Make sure that the thread passes under the pretension disk of the bobbin-winding thread guide correctly.

List of symptoms

■ Getting ready

| Symptom | Probable Cause | Remedy | Reference |
|--|---|--|------------|
| Cannot thread the needle. | Needle is not in the correct position. | Press the “Needle position” button to raise the needle. | B-4 |
| | Needle is installed incorrectly. | Reinstall the needle correctly. | B-31 |
| | Needle is turned, bent or the point is dull. | Replace the needle. | B-31 |
| | Upper threading is incorrect. | Check the steps for threading the machine and rethread the machine. | B-24 |
| | The needle threader hook is bent and does not pass through the eye of the needle. | Contact your authorized Brother dealer or the nearest Brother authorized service center. | – |
| | The needle threader lever cannot be moved or returned to its original position. | Contact your authorized Brother dealer or the nearest Brother authorized service center. | – |
| | A size 65/9 needle is being used. | The needle is incompatible with the needle threader. Manually pass the thread through the eye of the needle. | B-27 |
| Cannot lower the presser foot with the presser foot lever. | Presser foot was raised using the “Presser foot lifter” button. | Press the “Presser foot lifter” button to lower the presser foot. | B-4 |
| Bobbin thread does not wind neatly on the bobbin. | The thread is not passed through the bobbin winding thread guide correctly. | Correctly pass the thread through the bobbin winding thread guide. | B-18 |
| | Bobbin spins slowly. | Move the sewing speed controller to the right so that the speed will be increased. | B-18 |
| | The thread that was pulled out was not wound onto the bobbin correctly. | Wind the thread that was pulled off around the bobbin 5 or 6 times clockwise. | B-18 |
| | The empty bobbin was not set on the pin properly. | Set the empty bobbin on the pin and slowly turn the bobbin until you hear it click in place. | B-18 |
| While winding the bobbin, the bobbin thread was wound below the bobbin winder seat. | You have not wound the bobbin thread properly. While initially winding thread on the bobbin the bobbin thread is not properly inserted into the guides. | After removing the thread wound below the bobbin winder seat, wind the bobbin correctly. Follow the drawn images on the top of the machine for guidance when threading the machine for bobbin winding. | B-18, A-11 |
| The bobbin thread cannot be pulled up. | Needle is turned, bent or the point is dull. | Replace the needle. | B-31 |
| | Bobbin is set incorrectly. | Reset the bobbin correctly. | B-21 |
| Nothing appears in the LCD. | Main power switch is not turned on. | Turn the main power to ON. | B-10 |
| | The plug of the power cord is not inserted into an electrical outlet. | Insert the plug of the power cord into an electrical outlet. | B-10 |
| The LCD screen is fogged up. | Condensation has formed on the LCD screen. | After a while, the cloudiness will disappear. | – |
| The operation keys do not respond. | A glove is worn when the keys are pressed. The keys are pressed with a fingernail. A non-electrostatic touch pen is being used. | Directly touch the operation keys with your finger. | B-4 |
| The operation keys do not respond, or the sensitivity is too strong. | The sensitivity of the operation keys is not set for the user. | Adjust the sensitivity of the operation keys. | B-16 |



| Symptom | Probable Cause | Remedy | Reference |
|---|--|--|-----------|
| The sewing light does not come on. | The sewing light is damaged. | Contact your authorized Brother dealer or the nearest Brother authorized service center. | – |
| | “Light” is set to “OFF” in the settings screen. | Change the setting to “ON”. | B-15 |
| Embroidery unit does not operate. | Embroidery unit is not attached correctly. | Reattach the embroidery unit correctly. | B-54 |
| | Embroidery frame was attached before the unit was initialized. | Remove the embroidery frame, and then perform the initialization process correctly. | B-55 |

■ While sewing

| Symptom | Probable Cause | Remedy | Reference |
|--|--|--|-----------|
| Machine does not operate. | “Start/Stop” button was not pressed. | Press the “Start/Stop” button. | B-35 |
| | The bobbin winder shaft is pushed to the right. | Move the bobbin winder shaft to the left. | B-18 |
| | There is no pattern selected. | Select a pattern. | B-35 |
| | Presser foot is not lowered. | Lower the presser foot. | B-2 |
| | “Start/Stop” button was pressed with the foot controller attached. | Remove the foot controller, or use the foot controller to operate the machine. | B-37 |
| | The “Start/Stop” button was pressed while the machine is set for the sewing speed controller to control the zigzag stitch width. | Use the foot controller instead of the “Start/Stop” button to operate the machine, or set the “Width Control” to “OFF” in the settings screen. | B-13 |
| Needle breaks. | Needle is installed incorrectly. | Reinstall the needle correctly. | B-31 |
| | Needle clamp screw is not tightened. | Tighten the needle clamp screw. | B-31 |
| | Needle is turned or bent. | Replace the needle. | B-31 |
| | Using improper needle or thread for the selected fabric. | Check the “Fabric/thread/needle combinations” chart. | B-30 |
| | Wrong presser foot was used. | Use the recommended presser foot. | B-34 |
| | Upper thread tension is too tight. | Adjust the thread tension. | B-41 |
| | Fabric is pulled during sewing. | Do not pull the fabric during sewing. | – |
| | Spool cap is set incorrectly. | Check the method for attaching the spool cap, then reattach the spool cap. | B-18 |
| | There are scratches around the opening in the needle plate. | Replace the needle plate, or consult your authorized Brother dealer. | A-8 |
| | There are scratches around the opening in the presser foot. | Replace the presser foot, or consult your authorized Brother dealer. | B-33 |
| | There are scratches on the bobbin case. | Replace the bobbin case, or consult your authorized Brother dealer. | A-2 |
| | Needle is defective. | Replace the needle. | B-31 |
| | A bobbin designed specifically for this machine is not used. | Incorrect bobbins will not work properly. Only use a bobbin designed specifically for this machine. | B-18 |
| | Upper threading is incorrect. | Check the steps for threading the machine and rethread the machine. | B-24 |
| | Bobbin is set incorrectly. | Reset the bobbin correctly. | B-21 |
| | Presser foot is attached incorrectly. | Attach the presser foot correctly. | B-33 |
| Screw of the presser foot holder is loose. | Securely tighten the screw of the presser foot. | B-34 | |
| Fabric is too thick. | Use fabric that the needle can pierce when the handwheel is turned. | B-30, S-4 | |

| Symptom | Probable Cause | Remedy | Reference |
|---|--|---|------------|
| Needle breaks. | Fabric is fed forcefully when sewing thick fabric or thick seams. | Allow the fabric to be fed without being forcefully pushed. | S-4 |
| | Stitch length is too short. | Adjust the stitch length. | B-40 |
| | Stabilizer is not attached to fabric being embroidered. | Attach stabilizer. | B-57 |
| | Bobbin thread is incorrectly wound. | Use a correctly wound bobbin. | B-56 |
| Upper thread breaks. | Machine is not threaded correctly (used the wrong spool cap, spool cap is loose, the thread did not catch the needle bar threader, etc.) | Rethread the machine correctly. | B-24 |
| | Knotted or tangled thread is being used. | Remove any knots or tangles. | – |
| | The selected needle is not appropriate for the thread being used. | Select a needle that is appropriate for the type of thread being used. | B-30 |
| | Upper thread tension is too tight. | Adjust the thread tension. | B-41 |
| | Thread is tangled. | Use scissors, etc., to cut the tangled thread and remove it from the race, etc. | A-6 |
| | Needle is turned, bent or the point is dull. | Replace the needle. | B-31 |
| | Needle is installed incorrectly. | Reinstall the needle correctly. | B-31 |
| | There are scratches around the opening of the needle plate. | Replace the needle plate, or consult your authorized Brother dealer. | A-8 |
| | There are scratches around the opening in the presser foot. | Replace the presser foot, or consult your authorized Brother dealer. | B-33 |
| | There are scratches on the bobbin case. | Replace the bobbin case, or consult your authorized Brother dealer. | A-2 |
| | Using improper needle or thread for the selected fabric. | Check the “Fabric/thread/needle combinations” chart. | B-30 |
| | While sewing, the thread became knotted or tangled. | Rethread upper and lower thread. | B-21, B-24 |
| | A bobbin designed specifically for this machine is not used. | Incorrect bobbins will not work properly. Only use a bobbin designed specifically for this machine. | B-18 |
| The thread is tangled on the wrong side of the fabric. | Upper threading is incorrect. | Check the steps for threading the machine and rethread the machine. Be sure that the presser foot is in the raised position when threading the machine so that the upper thread sets properly in the upper tension. | B-24, A-6 |
| | Using improper needle or thread for the selected fabric. | Check the “Fabric/thread/needle combinations” chart. | B-30 |
| The upper thread is too tight. | The bobbin thread is incorrectly installed. | Correctly install the bobbin thread. | B-21, A-5 |
| Bobbin thread breaks. | Bobbin is set incorrectly. | Reset the bobbin correctly. | B-21 |
| | Bobbin thread is incorrectly wound. | Use a correctly wound bobbin. | B-18 |
| | There are scratches on the bobbin or it doesn’t rotate properly. | Replace the bobbin. | B-21 |
| | Thread is tangled. | Use scissors, etc. to cut the tangled thread and remove it from the race, etc. | A-8 |
| | A bobbin designed specifically for this machine is not used. | Incorrect bobbins will not work properly. Only use a bobbin designed specifically for this machine. | B-18 |



| Symptom | Probable Cause | Remedy | Reference |
|--|---|---|-----------|
| Fabric puckers. | There is a mistake in the upper or bobbin threading. | Check the steps for threading the machine and rethread it correctly. | B-24 |
| | Spool cap is set incorrectly. | Check the method for attaching the spool cap, then reattach the spool cap. | B-24 |
| | Using improper needle or thread for the selected fabric. | Check the "Fabric/thread/needle combinations" chart. | B-30 |
| | Needle is turned, bent or the point is dull. | Replace the needle. | B-31 |
| | Stitches are too long when sewing thin fabrics. | Shorten the stitch length. | B-40 |
| | Thread tension is set incorrectly. | Adjust the thread tension. | B-41 |
| | Wrong presser foot. | Use the correct presser foot. | B-34 |
| The stitch is not sewn correctly. | The presser foot that is used is not appropriate for the type of stitch that you wish to sew. | Attach the presser foot that is appropriate for the type of stitch that you wish to sew. | B-34 |
| | The thread tension is incorrect. | Adjust the tension of the upper thread. | B-41, A-7 |
| | The thread is tangled, for example, in the bobbin case. | Remove the tangle thread. If the thread is tangled in the bobbin case, clean the race. | A-8 |
| | Feed dogs are set in the down position. | Slide the feed dog position switch to the right (▲▲). | B-2 |
| Skipped stitches | Machine is threaded incorrectly. | Check the steps for threading the machine and rethread it correctly. | B-24 |
| | Using improper needle or thread for the selected fabric. | Check the "Fabric/thread/needle combinations" chart. | B-30 |
| | Needle is turned, bent or the point is dull. | Replace the needle. | B-31 |
| | Needle is installed incorrectly. | Reinstall the needle correctly. | B-31 |
| | Needle is defective. | Replace the needle. | B-31 |
| | Dust or lint has collected under the needle plate. | Remove the dust or lint with the brush. | A-2 |
| | Thin or stretch fabrics are being sewn. | Sew with one sheet of thin paper under the fabric. | S-4, D-4 |
| No stitching | Needle is turned, bent or the point is dull. | Replace the needle. | B-31 |
| | Bobbin is set incorrectly. | Reset the bobbin correctly. | B-21 |
| | Upper threading is incorrect. | Check the steps for threading the machine and rethread the machine. | B-24 |
| High-pitched sound while sewing | Dust or lint is caught in the feed dogs. | Remove the dust or lint. | A-2 |
| | Pieces of thread are caught in the race. | Clean the race. | A-2 |
| | Upper threading is incorrect. | Check the steps for threading the machine and rethread the machine. | B-24 |
| | A bobbin designed specifically for this machine is not used. | Incorrect bobbins will not work properly. Only use a bobbin designed specifically for this machine. | B-18 |
| | There are needle holes or friction scratches in the bobbin case. | Replace the bobbin case, or consult your authorized Brother dealer. | A-2 |
| Fabric does not feed through the machine. | Feed dogs are set in the down position. | Slide the feed dog position switch to the right (▲▲). | B-2 |
| | Stitches are too close together. | Lengthen the stitch length setting. | B-40 |
| | Wrong presser foot was used. | Use the correct presser foot. | B-34 |
| | Needle is turned, bent or the point is dull. | Replace the needle. | B-31 |

| Symptom | Probable Cause | Remedy | Reference |
|--|---|--|-----------|
| Fabric does not feed through the machine. | Thread is entangled. | Cut the entangled thread and remove it from the race. | A-8 |
| | Zigzag foot “J” is slanted on a thick seam at the beginning of stitching. | Use the presser foot locking pin (black button on the left side) on zigzag foot “J” to keep the presser foot level while sewing. | S-4 |
| | Presser foot pressure is set incorrectly for fabric. | Adjust presser foot pressure within the settings screen. | B-43 |
| The fabric feeds in the opposite direction. | The feed mechanism is damaged. | Contact your authorized Brother dealer or the nearest Brother authorized service center. | – |
| The needle contacts the needle plate. | The needle clamp screw is loose. | Firmly tighten the needle clamp screw. If the needle is bent or blunt, replace it with a new one. | B-31 |
| | Needle is turned, bent or the point is dull. | Replace the needle. | B-31 |
| Fabric being sewn with the machine cannot be removed. | Thread is tangled below the needle plate. | Lift up the fabric and cut the threads below it, and clean the race. | A-8 |
| A broken needle has fallen into the machine. | - | Turn off the machine, and remove the needle plate. If the needle that fell into the machine can be seen, use tweezers to remove it. After removing the needle, return the needle plate to its original position and insert a new needle. Before turning on the machine, slowly turn the handwheel toward you to check that it turns smoothly and that the new needle enters through the center of the needle plate opening. If the handwheel does not turn smoothly or the needle that fell into the machine cannot be removed, consult your authorized Brother dealer or the nearest Brother authorized service center. | A-8 |
| The handwheel feels sluggish when it is turned. | Thread is tangled in the bobbin case. | Remove the tangled thread from the bobbin case. Re-install the bobbin case so it is correctly positioned. | A-6, A-8 |

■ After sewing

| Symptom | Probable Cause | Remedy | Reference |
|-------------------------------------|--|---|-----------|
| Thread tension is incorrect. | Upper threading is incorrect. | Check the steps for threading the machine and rethread the machine. | B-24 |
| | Bobbin is set incorrectly. | Reset the bobbin. (If needle plate was removed, reinstall needle plate and tighten screws prior to installing bobbin case. Check to make sure needle enter through the center of needle plate opening.) | B-21, A-2 |
| | Using improper needle or thread for the selected fabric. | Check the “Fabric/thread/needle combinations” chart. | B-30 |
| | Presser foot holder is not attached correctly. | Reattach the presser foot holder correctly. | B-33 |
| | Thread tension is set incorrectly. | Adjust the thread tension. | B-41 |
| | Bobbin thread is incorrectly wound. | Use a correctly wound bobbin. | B-21 |
| | Needle is turned, bent or the point is dull. | Replace the needle. | B-31 |
| | A bobbin designed specifically for this machine is not used. | Incorrect bobbins will not work properly. Only use a bobbin designed specifically for this machine. | B-18 |





| Symptom | Probable Cause | Remedy | Reference |
|---|---|--|-----------|
| Character or decorative patterns are misaligned. | Pattern adjustment settings were set incorrectly. | Revise the pattern adjustment settings. | D-5 |
| Pattern does not turn out. | Wrong presser foot was used. | Attach the correct presser foot. | B-34 |
| | Did not use a stabilizer material on thin fabrics or stretch fabrics. | Attach a stabilizer material. | D-4 |
| | Thread tension is set incorrectly. | Adjust the thread tension. | B-41 |
| | Fabric was pulled, pushed or fed at an angle while it was being sewn. | Sew while guiding the fabric with your hands so that the fabric is fed in a straight line. | B-35 |
| | The thread is tangled, for example, in the bobbin case. | Remove the tangle thread. If the thread is tangled in the bobbin case, clean the race. | A-2 |
| Embroidery pattern does not sew out correctly. | Thread is twisted. | Use scissors, etc., to cut the twisted thread and remove it from the bobbin case, etc. | A-8 |
| | Thread tension is set incorrectly. | Adjust the thread tension. | B-41 |
| | Fabric was not inserted into the frame correctly (fabric was loose, etc.). | If the fabric is not taut in the frame, the pattern may turn out poorly or there may be shrinkage of the pattern. Set the fabric into the frame correctly. | B-58 |
| | Stabilizing material was not attached. | Always use stabilizing material, especially with stretch fabrics, lightweight fabrics, fabrics with a coarse weave, or fabrics that often cause pattern shrinkage. See your authorized Brother dealer for the proper stabilizer. | B-57 |
| | There was an object placed near the machine, and the carriage or embroidery frame hit the object during sewing. | If the frame bumps something during sewing, the pattern will turn out poorly. Do not place anything in the area where the frame may bump it during sewing. | B-56 |
| | Fabric outside the frame edges interferes with the sewing arm, so the embroidery unit cannot move. | Reinsert the fabric in the embroidery frame so that the excess fabric is away from the sewing arm, and rotate the pattern 180 degrees. | B-58 |
| | Fabric is too heavy, so the embroidery unit cannot move freely. | Place a large thick book or similar object under the arm head to lightly lift the heavy side and keep it level. | – |
| | Fabric is hanging off the table. | If the fabric is hanging off the table during embroidery, the embroidery unit will not move freely. Place the fabric so that it does not hang off the table or hold the fabric to keep it from dragging. | B-56 |
| | Fabric is snagged or caught on something. | Stop the machine and place the fabric so that it does not get caught or snagged. | – |
| | Embroidery frame was removed during sewing (for example, to reset the bobbin). The presser foot was bumped or moved while removing or attaching the embroidery frame, or the embroidery unit was moved. | If the presser foot is bumped or the embroidery unit is moved during sewing, the pattern will not turn out. Be careful when removing or reattaching the embroidery frame during sewing. | B-61 |
| Stabilizer is incorrectly attached, for example, it is smaller than the embroidery frame. | Attach the stabilizer correctly. | B-57 | |
| Loops appear on the surface of the fabric when embroidering. | The thread tension is incorrectly set. | Adjust the thread tension. | E-26 |
| | The combination of the bobbin case and bobbin thread is incorrect. | Change the bobbin case or bobbin thread so that the correct combination is used. | B-56 |

Error messages

When erroneous operations are performed messages and advice on operation will be displayed on the LCD. Follow what is displayed. If you press  or do the operation correctly while the error message is displayed, the message disappears.

| | Error messages | Cause/solution |
|----|---|--|
| 1 | A malfunction occurred. Turn the machine off, then on again. | This message is displayed if some malfunction occurs. Turn the machine off, then back on again. If this message continues to appear, the machine may be malfunctioning. Please contact your authorized Brother dealer or the nearest Brother authorized service center. |
| 2 | Cannot change the configuration of the characters. | This message is displayed when there are too many characters and the curved character configuration is impossible. |
| 3 | Cannot change the font since some letters are not included to the selected font. | This message appears when the font of the embroidery character pattern is changed to one that does not include characters used in the pattern. |
| 4 | Cannot recognize the data for the selected pattern. The data may be corrupted. Please turn off the power and turn on again. | This message appears when you try to retrieve pattern data that is invalid. Since any of the following may be the cause, check the pattern data. <ul style="list-style-type: none"> • The pattern data is damaged. • The data that you tried to retrieve was created using another manufacturer's data design system. Turn the machine off, then on again to return it to its normal condition. |
| 5 | Check and rethread the upper thread. | This message is displayed when the upper thread is broken or not threaded correctly, and the "Start/Stop" button, etc. is pressed. |
| 6 | Data volume is too large for this pattern. | This message is displayed when the patterns you are editing take up too much memory, or if you are editing too many patterns for the memory. |
| 7 | Lower the buttonhole lever. | This message is displayed when the buttonhole lever is up, a buttonhole stitch is selected, and the "Start/Stop" button, etc. is pressed. |
| 8 | Lower the presser foot lever. | This message is displayed when the "Presser foot lifter" button is pressed while the presser foot lever is raised/the needle is lowered. |
| 9 | No more patterns can be added to this combination. | This message is displayed when you tried to combine more than 70 decorative stitches. |
| 10 | Not enough available memory to save. | This message is displayed when the memory is full and the stitch or pattern cannot be saved. |
| 11 | Not enough available memory to save the pattern. Delete another pattern? | This message is displayed when the memory is full and the stitch or pattern cannot be saved. |
| 12 | OK to recall and resume previous memory? | This message appears if the machine is turned off while embroidering, then turned on again. Press  to return the machine to the condition (pattern position and number of stitches) when it was turned off. Follow the procedure described in "If the thread breaks during sewing" on page E-24 to align the needle position and embroider the remainder of the pattern. |
| 13 | Pattern extends to the outside of embroidery frame. | This message is displayed when the combined character pattern is too large for the embroidery frame. You can rotate the pattern 90 degrees and continue combining characters. |
| 14 | Pattern extends to the outside of embroidery frame. Add no additional characters. | This message is displayed when the character pattern combination is too large to fit in the embroidery frame. Change the character pattern size or layout the patterns to fit the embroidery frame. If "Embroidery Frame Identification View" is set to "ON", setting to "OFF" or selecting larger frame may help. |
| 15 | Pattern extends to the outside of embroidery frame. This function cannot be used at this time. | This message appears when the embroidery character pattern is resized or switched between written vertically/horizontally so that it is too large for the embroidery frame. |
| 16 | Preventive maintenance is recommended. | This message is displayed when the machine needs to be maintained. (page A-3) |
| 17 | Raise the buttonhole lever. | This message is displayed when the buttonhole lever is down, a stitch other than a buttonhole is selected, and the "Start/Stop" button, etc. is pressed. |

| | Error messages | Cause/solution |
|----|---|--|
| 18 | Selected pattern field extends to the outside of the embroidery frame. | This message appears when the selected embroidery pattern is larger than the extra large embroidery frame. Reduce the pattern size, or select a different pattern. This message appears when the selected embroidery pattern is larger than the embroidery frame selected when "Embroidery Frame Identification View" is set to "ON". |
| 19 | The bobbin thread is almost empty. | This message is displayed when the bobbin thread is running out. Follow the procedure described in "If the bobbin runs out of thread" on page E-23. |
| 20 | The bobbin winder safety device has activated. Is the thread tangled? | This message is displayed when the bobbin is being wound, and the motor locks because the thread is tangled, etc. |
| 21 |  The carriage of the embroidery unit will move. Keep your hands etc. away from the carriage. | This message appears before embroidery unit moves. |
| 22 | The pockets are full. Delete a pattern. | This message is displayed when the memory is full and a pattern must be deleted. |
| 23 |  The safety device has been activated. Is the thread tangled? Is the needle bent? | This message is displayed when the motor locks due to tangled thread or for other reasons related to thread delivery. |
| 24 | The "Start/Stop" button does not operate with the foot controller attached. Remove the foot controller. | This message is displayed when the "Start/Stop" button is pressed to sew Utility stitches or Character/Decorative stitches while the foot controller is connected. |
| 25 | The USB media was changed. Do not change the USB media while it is being read. | This message is displayed when you attempt to select a pattern after the USB flash drive in which the pattern is saved has been changed. |
| 26 | There is a pattern included that cannot be saved to USB media. Save the pattern in the machine's memory. | Depending on the pattern, it may not be possible to save it to a USB flash drive. |
| 27 | This pattern cannot be sewn with this mode. | This message is displayed when the selected stitch is not available for the specific function. |
| 28 | This pattern cannot be used. | This message appears when you try to retrieve a pattern that cannot be used with this machine. |
| 29 | This USB media cannot be used. | This message is displayed when you try to use incompatible media. |
| 30 |  Turn off the power and replace the needle plate. | This message is displayed when you try to sew with a stitch other than a straight stitch (middle needle position) while the straight stitch needle plate is installed. This message is also displayed when the needle plate is removed while the machine is still turned on. |
| 31 | USB media error | This message is displayed when an error occurs with the USB flash drive. |
| 32 | USB media is not loaded. Load USB media. | This message is displayed when you try to recall or save a pattern while no USB flash drive is loaded. |
| 33 | When the speed controller is set to control the zigzag stitch width, the "Start/Stop" button does not operate. | This message is displayed when the speed control lever is set to control the zigzag stitch width, and the "Start/Stop" button is pressed. Set "Width Control" to "OFF" in the settings screen (page B-13), or use the foot controller to operate the machine. |
| 34 | F** | If error message "F**" appears in the LCD while the sewing machine is being used, the machine may be malfunctioning. Contact your authorized Brother dealer or the nearest Brother authorized service center. |

Specifications

■ Sewing machine

| Item | Specification |
|-----------------------|--|
| Dimensions of machine | Approx. 480 mm (W) × 300 mm (H) × 249.4 mm (D) (Approx. 18-7/8 inches (W) × 11-7/8 inches (H) × 9-7/8 inches (D)) |
| Weight of machine | Approx. 9.8 kg (Approx. 21.6 lb) |
| Sewing speed | 70 to 850 stitches per minute |
| Needles | Home sewing machine needles (HA × 130) |

■ Embroidery unit

| Item | Specification |
|---|---|
| Dimensions of embroidery unit | Approx. 458 mm (W) × 131.8 mm (H) × 420.7 mm (D) (Approx. 18 inches (W) × 5-1/4 inches (H) × 16-1/2 inches (D)) |
| Dimensions of machine with embroidery unit attached | Approx. 693 mm (W) × 300 mm (H) × 420.8 mm (D) (Approx. 27-1/4 inches (W) × 11-7/8 inches (H) × 16-1/2 inches (D)) |
| Weight of embroidery unit | Approx. 3.5 kg (Approx. 7.7 lb) |

* Please be aware that some specifications may change without notice.

Upgrading your machine's software using USB flash drive

You can use USB flash drive to upgrade software for your sewing machine.

When an upgrade program is available on our website at "<http://support.brother.com/>", please download the file(s) following the instructions on the website and steps listed below.



Note

- When using USB flash drive to upgrade the software, check that no data other than the upgrade file is saved on the USB flash drive being used before starting to upgrade.
- Upgrade file can be recalled from a USB flash drive of any size.

- 1** Turn on the machine while pressing and holding (Presser foot lifter button).

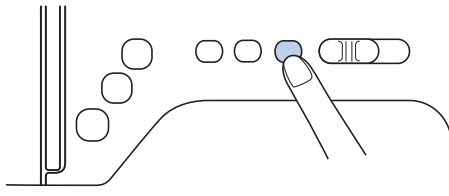

→ The following screen appears.



- 2** Insert the USB flash drive into the USB port on the machine. The media device should only contain the upgrade file.

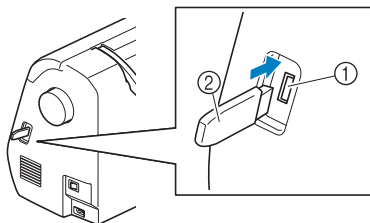

- ① USB port
- ② USB flash drive

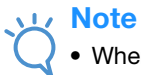

Note

- When using USB flash drive equipped with an access indicator, the access indicator will begin flashing after the media is inserted into your machine, and may take about 5 to 6 seconds before the media is recognized. (The length of time varies depending on the USB flash drive.)

- 3** Press **Load**.

→ The following screen appears.

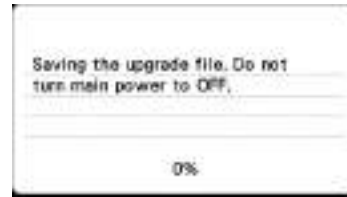

Note

- If an error occurred, a text error message will appear. At this time, turn the machine off, and then start the procedure again from step **1**.

- 4** When the following screen appears, upgrading is completed.



- 5** Remove the USB flash drive, and turn the machine off and on again.

Index

Numerics

| | |
|-------------------------------------|------|
| 1/4" quilting foot | S-28 |
| 1/4" quilting foot with guide | S-28 |
| 7 mm satin stitches | D-2 |

A

| | |
|--|-----------------|
| Accessories | |
| included accessories | B-6 |
| optional accessories | B-7 |
| Accessory compartment | B-5 |
| Adjustable zipper/piping foot | S-23 |
| Adjusting stitch length | B-40 |
| Adjusting stitch width | B-40 |
| Adjusting thread tension | B-41 |
| Air vent | B-2 |
| Aligning the position | E-15 |
| Alphabet characters | |
| character/decorative stitches | D-2 |
| embroidery edit | E-2 |
| Appliqué | S-26 |
| using an embroidery frame pattern | E-18 |
| using frame pattern to make appliqué | E-20 |
| Array key | E-12 |
| Arrow keys | D-22, E-6, E-13 |
| Attaching presser foot holder | B-34 |
| Automatic fabric sensor system | B-44 |
| Automatic reinforcement stitch key | B-38 |
| Automatic thread cutting | B-43 |

B

| | |
|-----------------------------------|------------------------|
| Back key | B-4 |
| Back to beginning key | D-10 |
| Bar tack stitch | S-35 |
| Basic sewing | B-35 |
| Basic stitching | S-6 |
| Basting stitch | S-6 |
| Beep | A-4 |
| Blind hem stitch | S-8 |
| Block move key | D-23 |
| Bobbin | |
| runs out of thread | E-23 |
| Bobbin case | B-3, B-56 |
| Bobbin case removal | A-2 |
| Bobbin cover | B-3 |
| Bobbin installation | B-21 |
| Bobbin thread | |
| pulling up | B-27 |
| winding | B-18 |
| Bobbin winder | B-2 |
| Bobbin winding | B-18 |
| Bobbin winding thread guide | B-2, B-18 |
| "bPocket" folder | B-17, D-16, D-24, E-33 |
| Button guide plate | S-15 |
| Button sewing | S-17 |
| Buttonhole lever | B-3, S-15 |
| Buttonhole sewing | S-14 |
| Buttonhole stitching | S-14 |
| Buzzer | A-4 |

C

| | |
|---------------------------------|------|
| Care | A-2 |
| Changing sewing direction | S-2 |
| Character spacing key | E-10 |
| Character stitches | D-2 |
| Character/decorative stitches | |
| adjustments | D-5 |

| | |
|-------------------------------------|------------|
| combining | D-12 |
| editing | D-7 |
| retrieving | D-17 |
| saving | D-15, D-16 |
| selecting | D-2 |
| sewing | D-4 |
| Checking needle | B-31 |
| Cleaning | |
| LCD screen | A-2 |
| machine surface | A-2 |
| race | A-2 |
| Combining patterns | |
| character/decorative stitches | D-12 |
| embroidery patterns | E-13 |
| Concealed seams | S-19 |
| Crazy quilt stitching | S-27 |
| Cross stitch stitches | D-2 |
| Curve sewing | S-2 |
| Cut/Tension key | E-26 |
| Cutting thread automatically | B-43 |
| Cylindrical pieces | S-2 |

D

| | |
|--------------------------------------|------|
| Darning | S-36 |
| Darning stitch | S-35 |
| Decorative stitches & patterns | D-2 |
| Density key | E-7 |
| Drawnwork | S-44 |

E

| | |
|--|------------|
| Editing | |
| character/decorative stitches | D-7 |
| MY CUSTOM STITCH | D-21 |
| Elongation key | D-9 |
| Embroidering | B-64 |
| Embroidering pattern | B-64 |
| Embroidering steps | B-52 |
| Embroidery | |
| automatic thread cutting function (END COLOR TRIM) | E-28 |
| edges or corners | B-60 |
| restarting from the beginning | E-24 |
| resuming embroidery after turning off the power | E-24 |
| ribbons or tape | B-60 |
| small fabrics | B-60 |
| thread color display | B-65 |
| Embroidery edit | |
| changing the thread color | E-7 |
| combined patterns | E-13, E-14 |
| key functions | E-5 |
| Embroidery foot installation | B-53 |
| Embroidery frame display | E-28 |
| Embroidery frames | |
| inserting fabric | B-58 |
| removing | B-61 |
| types | B-58 |
| using the embroidery sheet | B-59 |
| Embroidery key | B-4, E-8 |
| Embroidery pattern selection | B-62 |
| Embroidery pattern types | B-62 |
| Embroidery patterns | |
| aligning the position | E-15 |
| checking the position | B-63 |
| combining | E-13 |
| editing | E-5 |
| patterns which use appliqué | E-18 |
| retrieving | E-33, E-34 |
| saving | E-32, E-33 |
| selecting | E-2 |

A

MAINTENANCE AND TROUBLESHOOTING

| | |
|---|------------|
| using a frame pattern to make an appliqué | E-20, E-21 |
| Embroidery sheet | B-59 |
| Embroidery unit | B-3 |
| attachment | B-54 |
| carriage | B-54 |
| removal | B-55 |
| Embroidery unit removal | B-55 |
| Error messages | A-19 |
| Even seam allowance | S-3 |
| Eyelet stitching | S-38 |

F

| | |
|--|------|
| Fagoting | S-41 |
| Feed dog position switch | B-2 |
| Feed dogs | B-3 |
| Flat bed attachment | B-2 |
| Foot controller | B-37 |
| Foot controller jack | B-3 |
| Forward/Back key | E-24 |
| Fraying, preventing | S-11 |
| Free motion quilting | S-30 |
| free motion echo quilting foot "E" | S-32 |
| free motion open toe quilting foot "O" | S-30 |
| free motion quilting foot "C" | S-31 |
| Front view | B-2 |

H

| | |
|----------------------------|-----------|
| Handle | B-2 |
| Handwheel | B-2 |
| Heirloom stitching | S-44 |
| Help key | B-4, B-17 |
| Horizontal spool pin | B-28 |
| Horizontal stitching | S-39 |

I

| | |
|--------------------------|------------|
| Image key | B-63, D-11 |
| Insert key | D-23 |
| Inserting a piping | S-24 |
| Installing bobbin | B-21 |

J

| | |
|---------------|------|
| Joining | S-43 |
|---------------|------|

K

| | |
|---------------------------------|-----------|
| Key functions | |
| embroidery settings | E-15 |
| font edit | E-9 |
| MY CUSTOM STITCH | D-21 |
| pattern edit | E-5 |
| Knee lifter | B-46 |
| Knee lifter mounting slot | B-2, B-46 |

L

| | |
|-----------------------------|------|
| L/R Shift | B-41 |
| LCD | B-4 |
| LCD messages | A-19 |
| LCD operation | B-11 |
| LCD screen | |
| cleaning | A-2 |
| Leather/vinyl fabrics | S-5 |

M

| | |
|--------------------------------|----------------|
| Machine surface cleaning | A-2 |
| Main power switch | B-2 |
| Maintenance | A-2 |
| Manual needle threading | B-27 |
| Mirror image key | B-43, D-9, E-7 |

| | |
|----------------------------|------|
| Mirroring stitches | B-43 |
| Multi color key | E-9 |
| MY CUSTOM STITCH | |
| designing | D-19 |
| entering data | D-21 |
| key functions | D-21 |
| retrieving | D-24 |
| saving | D-24 |
| storing in your list | D-24 |

N

Needle

| | |
|-------------------------------|------|
| condition | B-31 |
| position | S-7 |
| replacement | B-31 |
| threading | B-26 |
| types, sizes & uses | B-30 |
| Needle bar thread guide | B-3 |
| Needle plate | B-3 |
| Needle plate cover | B-3 |
| Needle plate marking | S-3 |
| Needle position button | B-4 |
| Needle threader | B-26 |
| Needle threader lever | B-2 |
| Next page key | B-4 |
| Non stick foot | S-5 |

O

| | |
|----------------------------|------------|
| Operating procedures | B-17 |
| Operation beep | A-4 |
| Operation buttons | B-4 |
| Operation keys | B-4, B-16 |
| Operation panel | B-2, B-4 |
| Operation problems | A-5 |
| Optional accessories | B-7 |
| Overcasting stitches | S-11, S-12 |

P

| | |
|--|------------|
| Pant legs | S-2 |
| Parallel stitches | B-28 |
| Part names & functions | B-2 |
| Patchwork | S-26, S-27 |
| Pattern embroidery | B-64 |
| Piecing | S-27 |
| Piping inserting | S-24 |
| Pivoting | B-44 |
| Power supply jack | B-2 |
| Power switch | B-2 |
| Presser foot | B-3 |
| adjusting pressure | B-43, B-44 |
| Presser foot holder | B-3 |
| Presser foot holder installation | B-34 |
| Presser foot holder removal | B-34 |
| Presser foot replacement | B-33 |
| Presser foot/Needle exchange key | B-4 |
| Previous page key | B-4 |
| Pulling up bobbin thread | B-27 |

Q

| | |
|----------------------|------|
| Quilting | S-29 |
| Quilting guide | S-30 |

R

| | |
|------------------------------------|-----------|
| Race | A-2 |
| Reinforcement stitch button | B-4, B-38 |
| Reinforcement stitching | S-35 |
| Release button | B-55 |
| Removing presser foot holder | B-34 |
| Replacing needle | B-31 |

| | |
|--|------------|
| Replacing presser foot | B-33 |
| Retrieving | |
| character/decorative stitch patterns | D-17 |
| machine's memory | D-17, E-33 |
| MY CUSTOM STITCH designs | D-24 |
| USB media | D-17, E-34 |
| Reverse stitch button | B-4, B-38 |
| Reverse/reinforcement stitches | B-38 |
| Rotate key | E-6 |

S

| | |
|---|-----------------|
| Satin stitches | D-2 |
| Satin stitching | S-34 |
| Saving | |
| character/decorative stitches | D-15 |
| machine's memory | D-15, E-32 |
| MY CUSTOM STITCH designs | D-24 |
| USB media | D-16, E-33 |
| Scallop stitching | S-42 |
| Seam allowance, even | S-3 |
| Seam ripper | S-16 |
| Selecting embroidery patterns | B-62 |
| Set key | D-22 |
| Settings | |
| automatic reinforcement stitching | B-38 |
| automatic thread cutting | E-28 |
| display language | B-16 |
| thread tension | E-26 |
| Settings key | B-4 |
| Sewing basics | B-35 |
| Sewing direction change | S-2 |
| Sewing speed controller | B-4, S-34 |
| Shell tuck stitch | S-43 |
| Side cutter | S-12 |
| Single/repeat sewing key | D-9 |
| Single/triple stitching key | D-22 |
| Size key | E-6 |
| Size selection key | D-9 |
| Smocking | S-42 |
| Solving operation problems | A-5 |
| Spool net | B-19 |
| Stabilizer | B-57 |
| "Start/Stop" button | B-4 |
| Starting point key | E-15 |
| Step stitch patterns | D-14 |
| Stippling | S-26 |
| Stitch guide foot | S-3 |
| Stitch length adjustment | B-40 |
| Stitch settings | B-47 |
| Stitch types | B-35 |
| Stitch width adjustment | B-40 |
| Straight stitch | S-6, S-19, S-27 |
| Stretch fabrics | S-5 |

T

| | |
|---------------------------------|-----------|
| Test key | D-24 |
| Thick fabrics | S-4 |
| Thin fabrics | S-4 |
| Thread color display | B-65 |
| Thread cutter | B-2, B-37 |
| Thread cutter button | B-4 |
| Thread cutting, automatic | B-43 |
| Thread density key | D-10 |
| Thread guide plate | B-2 |
| Thread palette key | E-7 |
| Thread tension | E-26 |
| Thread tension adjustment | B-41 |
| Threading | B-24 |
| Threading needle | B-26 |
| Threading needle manually | B-27 |
| Tips | S-2 |
| Top cover | B-2 |

| | |
|-----------------------------|-----------|
| Touch panel | B-4 |
| Touch pen | B-4, B-16 |
| Trial key | B-63 |
| Trial sewing | S-2 |
| Triple stretch stitch | S-6, S-35 |
| Troubleshooting | A-5 |
| Twin needle | B-28 |
| Twin needle sewing | B-28 |

U

| | |
|---------------------------------------|------------|
| Upgrading | A-22 |
| Upper thread | B-24 |
| Upper thread spool | B-24 |
| Upper thread tension | B-41 |
| USB media | |
| recalling | D-17, E-34 |
| saving | D-16, E-33 |
| usable | D-15, E-31 |
| USB port connector | B-3 |
| for media | D-16, E-33 |
| Utility stitch key | B-4 |
| Utility stitch selection screen | B-12 |

W

| | |
|----------------------|------|
| Winding bobbin | B-18 |
| Wing needle | S-44 |

Z

| | |
|-------------------------------|------------|
| Zigzag stitches | S-12, S-26 |
| Zigzag width adjustment | B-40 |
| Zipper insertion | |
| centered | S-19, S-23 |
| side | S-20 |

A

Please visit us at <http://support.brother.com/> where you can get product support and answers to frequently asked questions (FAQs).

English
888-G00/G02/G04/G05
Printed in Vietnam



XF9595-001①